

# LUMARY SMART RGBAI LINEAR LIGHT USER MANUAL



Lumary

Thank you for choosing Lumary! Are you excited to embark on a journey of smart living? Begin by downloading the Lumary App, your gateway to effortlessly managing your smart devices from anywhere using your smartphone or tablet. Our products seamlessly integrate with your home Wi-Fi, enabling you to command multiple devices with the mere touch of your fingertips.

At Lumary, we pride ourselves on being a leading producer of smart lighting solutions, dedicated to delivering unparalleled service. We are constantly refining our app and products to ensure that we meet and exceed your expectations. So, why wait? Illuminate your home with the sophistication and convenience of Lumary today. Let's make your space brighter and your life smarter.

# Contents

---

Product & Notes	3-4
Installation	5-7
Application Connection	8-13
Group Control	14-16
UI Function Introduction	17-20
FAQ	21-24
Important Information	25-26
App-To-App Voice Control	27-34

# Product&Notes

## What's in the Box

---



- Lumary Smart RGBAI Linear Light

### PACKAGE CONTENTS

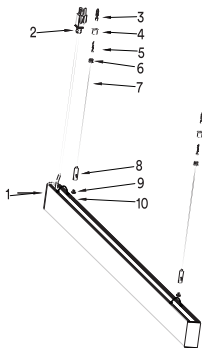

1. Lamp body	1PCS
2. Plug cable	1PCS
3. Expansion tube	2PCS
4. Fixed head 2	2PCS
5. Screw	2PCS
6. Fixed head 1	2PCS
7. Steel wire rope	2PCS
8. Wire locker	2PCS
9. Screw	2PCS
10. Steel wire rope	2PCS

## Get Ready

---

- Know your Wi-Fi network and password.
- Make sure your mobile device is running iOS 13.3 or higher and Android 9.0 or higher.
- Make sure you're connecting to a 2.4GHz Wi-Fi network (Lumary can't connect to 5GHz networks).

## ▲ SAFETY INFORMATION

Please read carefully and save these instructions, as you may need them at a later date. When using electrical equipment, basic safety precautions should always be followed as below:

### WARNING:

1. Please read the specification first, to make sure the service environment matches the condition in the specification before using.
2. Please confirm the applicable power supply before using.
3. Make sure the switch of product is off before connecting Dimensions to the power supply to prevent electric shock.
4. Operation against rules may damage your property even harm to your personal safety.
5. Preliminarily estimate required quantity of LED linear lights, then according to the power rating of single linear to figure out the total power and design power supply plan.
6. Dangerous high voltage, non-professionals are not allowed to maintain the products.
7. If the exterior flexible cable or wire is damaged, it must be exchanged by the supplier, its agent or other similar qualified personnels to avoid dangers.

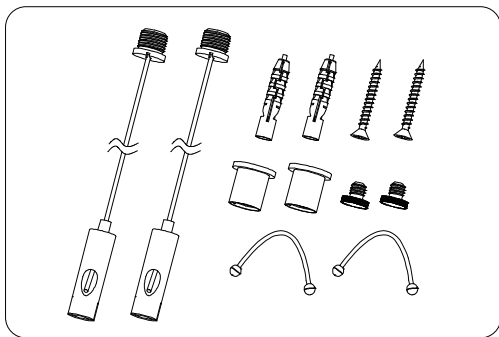

# Installation steps:

1. Plan the distance between the installation holes first, then drill 2  $\Phi 3$ mm and 1  $\Phi 7$ mm holes in the cement ceiling, and knock the rubber plug into the 2  $\Phi 3$ mm holes with a hammer.
2. Thread the screw through the fixed head 2 and use a screwdriver to lock the fixed head 2 in the rubber plug.

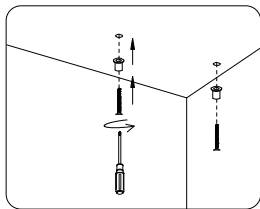
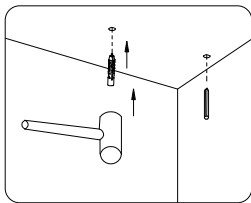

3. Rotate and tighten the assembled lamp with fixed head 1 and fixed head 2.
4. Install the steel wire rope on the lamp to the wire locker, and then twist the screws.

Choose your wiring method:

- ① Plug directly into the socket, and installation is complete.
- ② Drill a hole in the ceiling, connect white to white and black to black.

Also, connect the green wire to the green wire for grounding, and installation is complete.

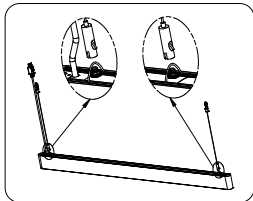
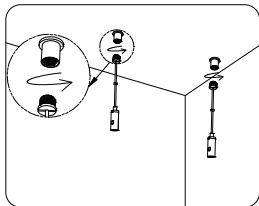

## Two installation options:

① Plug directly into the socket.

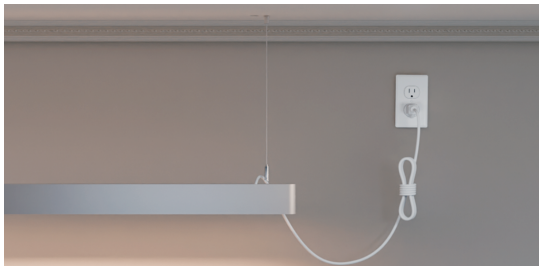

② Cut off the plug, drill a hole in the ceiling, and hardwire the power cord.  
Suitable for ceilings with enough space and power cords.

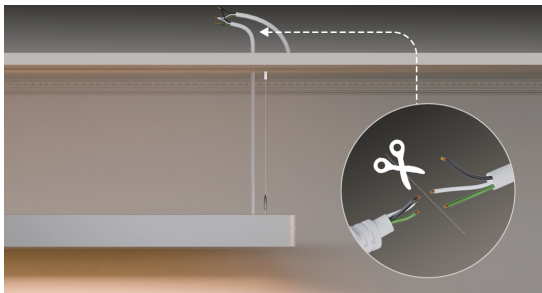

(NOTE: Please make sure the installation method before installation)

## Remote Button function

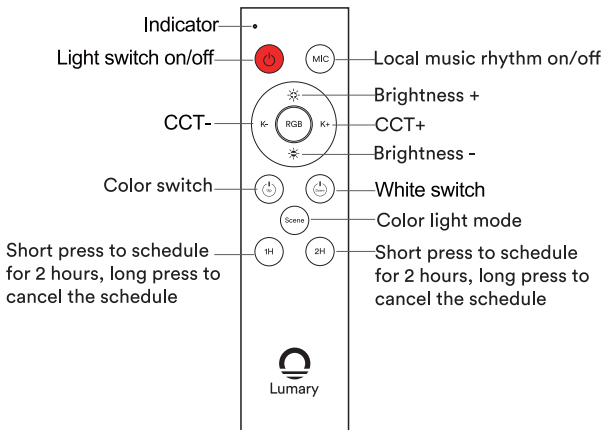

### The light enters the reset distribution state:

1. Lights power on and off 3 times, lights will appear flashing or breathing state.
2. Long press the remote control ON/OFF button for 5s, the light will appear blinking or breathing state.

### Remote control pairing:

1. First, the light needs to be bound to the Lumary App.
2. Unplug it and power it on again, within 20s it is equal to the remote control in pairing mode, long press the remote control ON/Off button for 2-3s, the white light will flash 3 times when pairing is successful.

# Install the "Lumary" App

1. Find and install the "Lumary" App on App Store, Google Play.

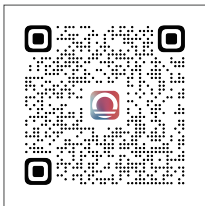
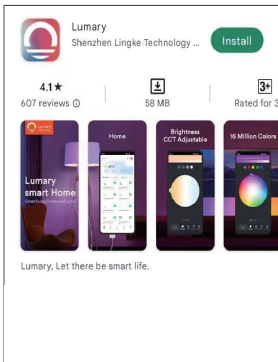
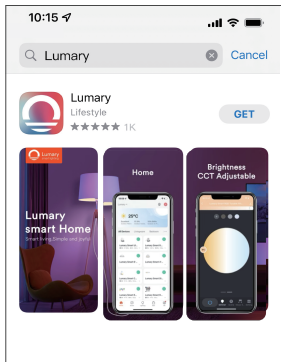

## 2. Register a Lumary account.

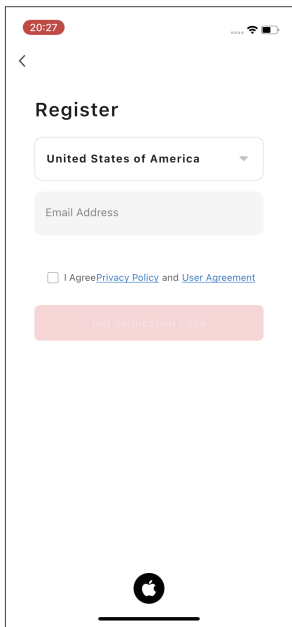

The screenshot shows the 'Register' screen. At the top left is a back arrow and the time '20:27'. At the top right are signal, Wi-Fi, and battery icons. The main heading is 'Register'. Below it is a dropdown menu showing 'United States of America'. Underneath is an 'Email Address' input field. Below the input field is a checkbox with the text 'I Agree [Privacy Policy](#) and [User Agreement](#)'. At the bottom is a red button labeled 'Get Verification Code'. The home indicator bar with the Apple logo is at the very bottom.

Enter your email address.

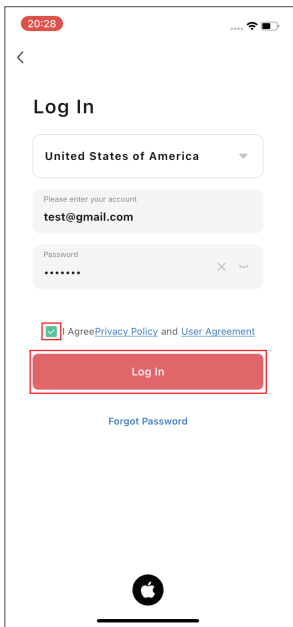

The screenshot shows the 'Log In' screen. At the top left is a back arrow and the time '20:28'. At the top right are signal, Wi-Fi, and battery icons. The main heading is 'Log In'. Below it is a dropdown menu showing 'United States of America'. Underneath is a text input field with the placeholder 'Please enter your account' and the value 'test@gmail.com'. Below that is a 'Password' input field with a masked password '.....' and a 'Show/Hide' icon. Below the password field is a checked checkbox with the text 'I Agree [Privacy Policy](#) and [User Agreement](#)'. At the bottom is a red button labeled 'Log In'. Below the button is a blue link labeled 'Forgot Password'. The home indicator bar with the Apple logo is at the very bottom.

Log into the App.

Note: Please select your region and country.

### 3. Connect

**NOTE: Lumary's products can't connect to 5GHz networks.**

Steps:

1. **Advised to enable Bluetooth, Enable Bluetooth to add some Wi-Fi device easily;**
2. Each time the device without distribution network is powered on, confirm the light is breathing or blinking pairing mode;
3. Open the Lumary App, In the top corner of the Devices screen, click "+" and select "Add Device" to confirm that the device is paired.

**If not, you need to use the wall switch to reset: on-off-on-off-on;  
Or long press the remote control ON/OFF button for 5s, the light will appear blinking or breathing state.**

4. Find the device, choose Wi-Fi and enter password, press "Next". Click "Add", and wait patiently. After that, click "Done", and the device is successfully added to the App.

5. Other ways to add devices, Open the Lumary App >> In the top corner, click "+" >> Choose "Lighting" >> Select "Light Source (BLE + Wi-Fi)" >> Select "AP Mode" or "EZ Mode" in the upper right corner.

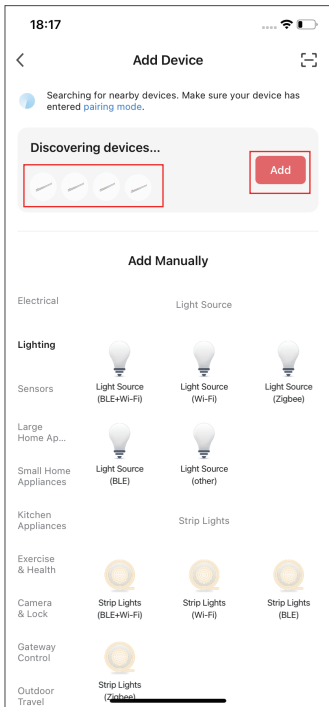
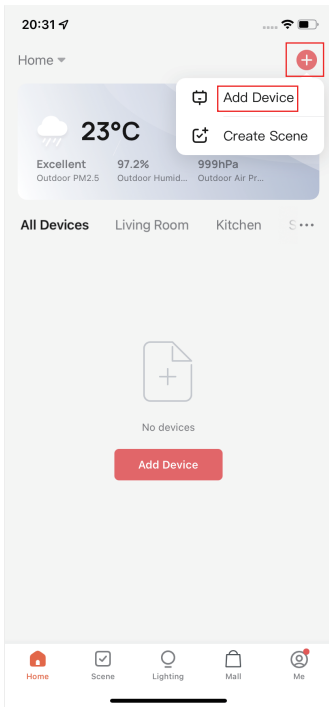

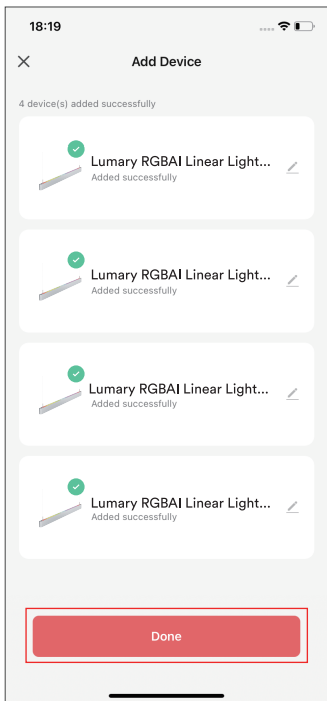
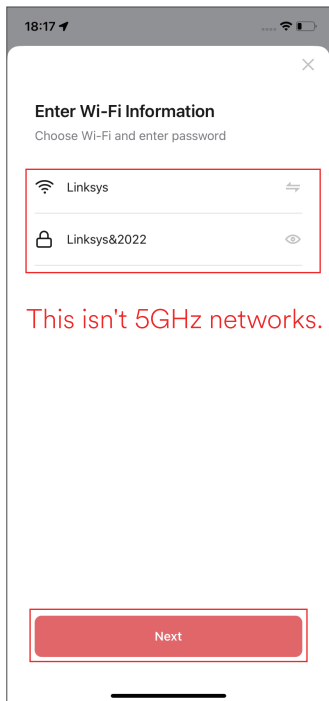

## 4. Troubleshooting

1. Can't connect to your Wi-Fi network.

Make sure you entered the correct Wi-Fi password during the Wi-Fi setup. Check whether there are any Internet connection problems. If the Wi-Fi signal is too weak, reset your Wi-Fi router and try again.

2. If you fail to bind, you will need two phones, one to set the hotspot and the other to connect the hotspot and add the device through the app. If the device is successfully added, the device is normal. The problem may be in the router, you need to check your router Settings to see if there are MAC and DHCP restrictions. Lumary's products do not support 5GHz networks.

3. If you have any questions. You can contact us via our after-sales email: [support@lumary.tech](mailto:support@lumary.tech) or leave a message on our official social media account.

# Group Control

1. Log in to Lumary App, tap the smart device and enter into, click "✎" in the top right corner.

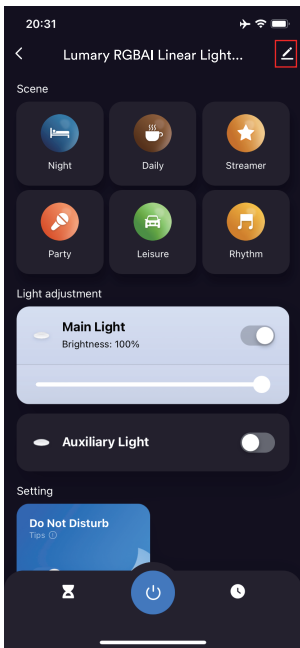
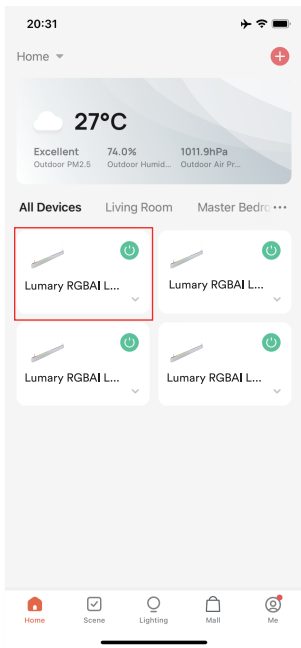

2. Click "Create Group", then select a device and save.

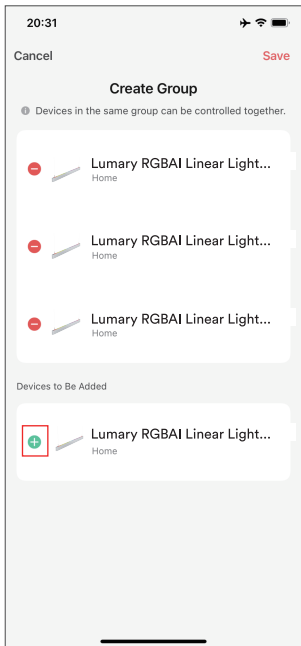
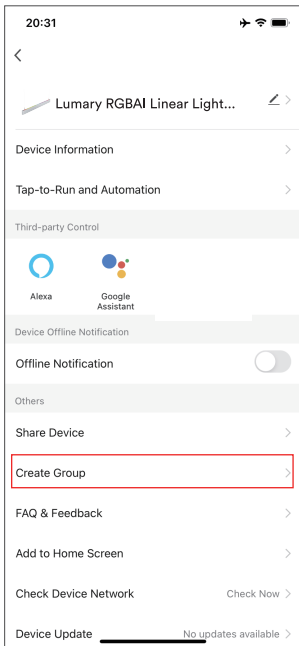

3. You can reset the group name and save it, and the group can control devices.

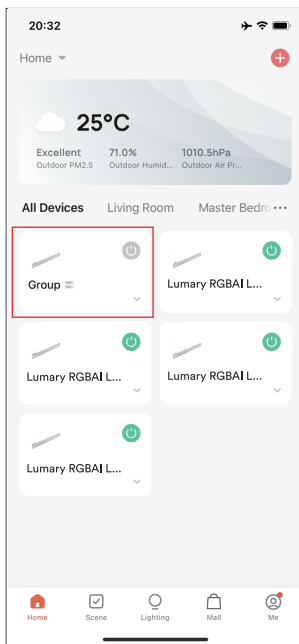
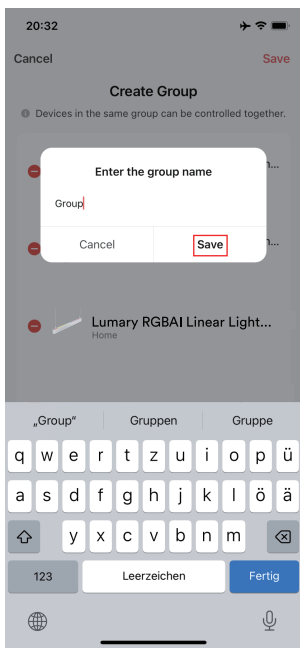

## UI Function Introduction

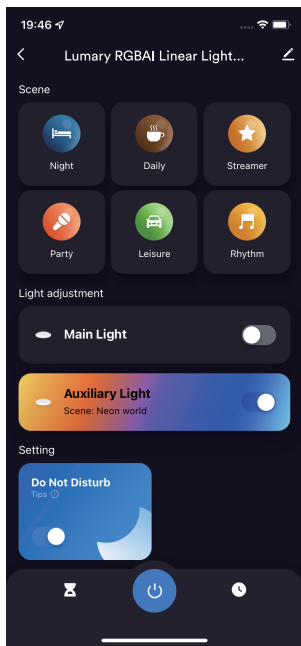

The main light and auxiliary light can't be turned on at the same time. You can press and hold any icon to enter the new UI.

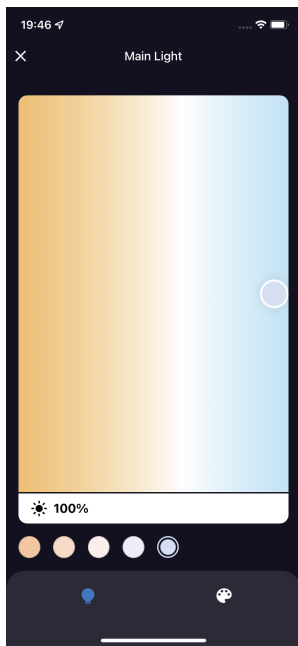

**Main light** adjust brightness and color temperature.

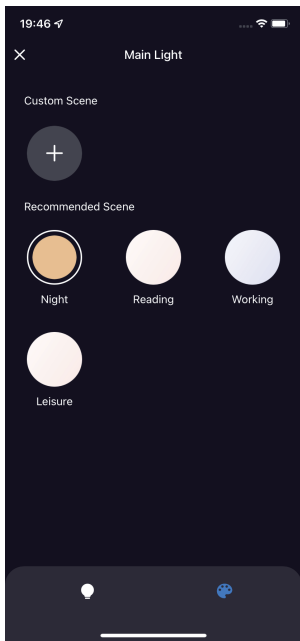

**Main light**  
scene setting UI.

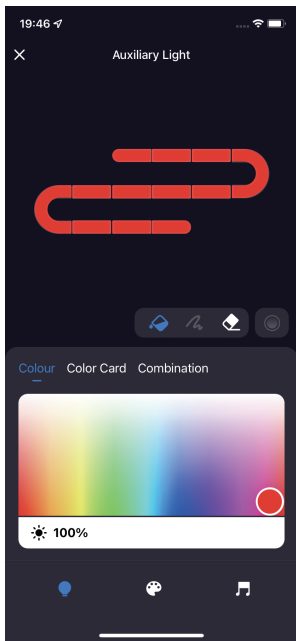

**Auxiliary light**  
RGBAI setting UI.  
**Paint bucket filling adjustment**  
You can adjust the color and saturation, brightness and color card directly to the designed color block through the color disk in the color light interface.

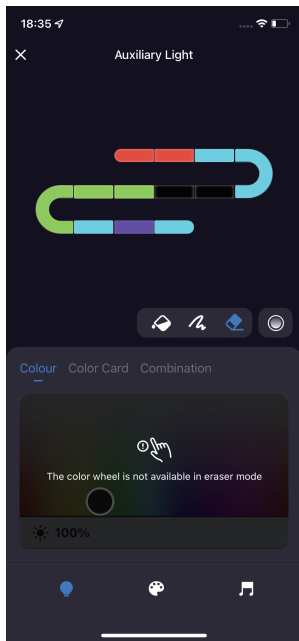
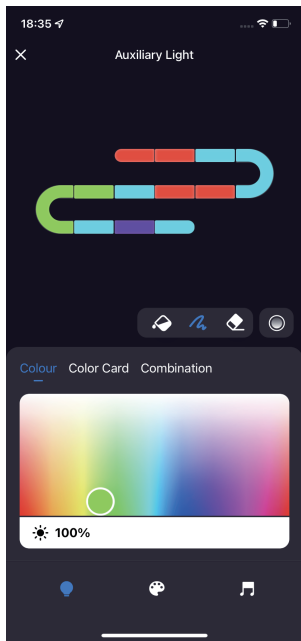

### Eraser

In the color light or color card to choose the desired color, you can click or slide to smear the area above the strip of light, the strip of light to change the color, switch to like the skin eraser, it will click or slide to select the strip of light out.

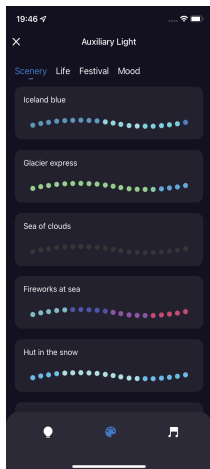
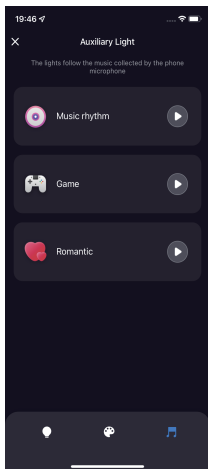
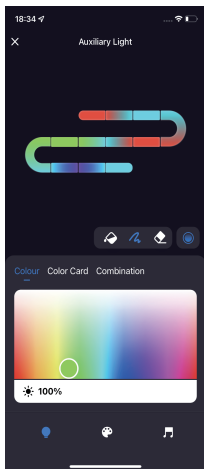

## Color transition

When the light with multiple color light color smear, you can click the transition button to switch to the color transition state.

## Music & Science

## FAQ

---

### **1. What should I do, if I don't have internet access to my Lumary product?**

If you do not have a network, you will need two mobile phones, one to set up the hotspot and the other to connect to the hotspot and add the device via the app (refer to the guide).

### **2.If my Wi-Fi internet goes down, will Lumary App still work?**

Lumary products need to be connected to Wi-Fi in order to use them remotely, and the device can be controlled simply using the app via the LAN as well as Bluetooth.For example: on, off, dimming, colour temperature, colors.

### **3. Why does the flickering occur with Lumary products?**

Lumary's products are factory set to the default network configuration. If the device has not been connected to the network, it will flash for three minutes each time it is powered on. If the device has not been connected to the network, it will flash for three minutes every time it is powered on. If the device is connected to the network, it will stop flashing and will automatically connect to the network when it is switched off and on via the wall switch after 15 seconds.

## **4.Can I share with family and friends?**

Yes, you can share access to your Lumary devices. In the Lumary App, from your main device list, click on one of the devices press the "... " button on the top right and click on "Share Device" to give or revoke sharing permissions. In order to share, the other user should already have downloaded the Lumary App and registered an account.

## **5.Can I group multiple Lumary devices together?**

Yes, you can group multiple same-type devices by room, location, or however else you want. The same devices can be in multiple groups. For example, if you create a group for "Bedroom" and another group for "Entire House" ,your Bedroom lights can be included in both groups. From your main device list, click on one of the devices you want to group, press the "... " button on the top right for advanced settings, and click "Create Group" .You'll be able to name a new group and choose which devices you'd like to group together.

## **6.My Lumary device has a funny name. How do I rename it?**

From your main device list, click on one of the devices you want to rename, press the "... " button on the top right for advanced settings, and click "Modify Device Name" (or "Modify Group Name"). You'll then be able to choose a more familiar name. cally connect to the network when it is switched off and on via the wall switch after 15 seconds.

## 7.What's the wireless range?

The range of your home Wi-Fi is heavily dependent on your home router and the conditions of the room. Check with your router specifications for exact range data.

## 8.What should I do if the device Appears offline or is unreachable?

Make sure your Wi-Fi router is online and in range, and check that you have the latest Lumary functionality by clicking "Check for firmware update" in your device settings. Try to turn off the device >> clear the application cache >> reboot the router >> turn on the device after one minute and check and confirm the device status after five minutes.

## 9.How many devices can I control?

- The maximum number of timers that can be added to a single device: 30
- Maximum number of devices that can be added in a single home: 120
- The maximum number of Tap-to-Run that a single home can create: 100
- Maximum number of Automation that can be created in a single home: 100
- The maximum number of tasks that can be added in a Tap-to-Run: 150
- The maximum number of tasks that can be added in an Automation: 150
- The maximum number of conditions that can be added in an Automation: 10
- The maximum number of mobile devices that can simultaneously log in to an account is: 200
- The maximum number of Homes that can be created by a single App account is: 20
- The maximum number of home members that can be added in a single home is: 20
- The maximum number of rooms that a single home can create is: 20
- The maximum number of devices that can be added in a single room is: 50

- The maximum number of devices that can be added in a single device group is: 100
- The maximum number of device groups that a single home can create is: 20
- The maximum number of each device group that can be shared with other users is: 20
- The maximum number of each device that can be shared with other users is: 20
- The maximum number of each App account that can be invited by other homes is: 20

## **10.What should I do,when I find a problem with the purchased product?**

Please email us ([support@lumary.tech](mailto:support@lumary.tech)) with your Amazon order ID. We are dedicated to ensuring your 100% satisfaction. Rest assured if the problem is with this product, we'll be more than happy to exchange it for a new one immediately.

## Important Information

---

### Troubleshooting

Can't connect to your Wi-Fi network.

Make sure you entered the correct Wi-Fi password during the Wi-Fi setup.

Check whether there are any Internet connection problems. If the Wi-Fi signal is too weak, reset your Wi-Fi router and try again.

## Parameter information

---

Name	Lumary Smart RGBAI Linear Light
Model	L-LL4A1
Input Voltage	100-277VAC,60Hz
Wattage	Max.40W
Color Temperature	RGBAI +Tunable White(2200K-6500K )
CRI	90+
Lumens	3000lm(6500K)
Beam Angle	108°
Rated Life	25000h



Contains FCC ID:2ANDL-CBU

Made in China

## CAUTION:

This device complies with Part 15 of the FCC Rules. Operation is subject to the following two conditions:

(1) this device may not cause harmful interference, and (2) this device must accept any interference received, including interference that may cause undesired operation. Changes or modifications not expressly approved by the party responsible for compliance could void the user's authority to operate the equipment.

NOTE: This equipment has been tested and found to comply with the limits for a Class B digital device, pursuant to part 15 of the FCC Rules. These limits are designed to provide reasonable protection against harmful interference in a residential installation. This equipment generates uses and can radiate radio frequency energy and, if not installed and used in accordance with the instructions, may cause harmful interference to radio communications. However, there is no guarantee that interference will not occur in a particular installation. If this equipment does cause harmful interference to radio or television reception, which can be determined by turning the equipment off and on, the user is encouraged to try to correct the interference by one or more of the following measures:

- Reorient or relocate the receiving antenna.
- Increase the separation between the equipment and receiver.
- Connect the equipment into an outlet on a circuit different from that to which the receiver is connected.
- Consult the dealer or an experienced radio/TV technician for help.

# VOICE CONTROL GUIDE

Name and Control Each Device by Voice



# Voice Control Quick Guide for Amazon Alexa

1. Log in to Lumary App, tap the smart device and enter into, click "✎" in the top right corner.

2. Tap "Alexa" in Third-party Control.

3. Tap "Sign In With Amazon".

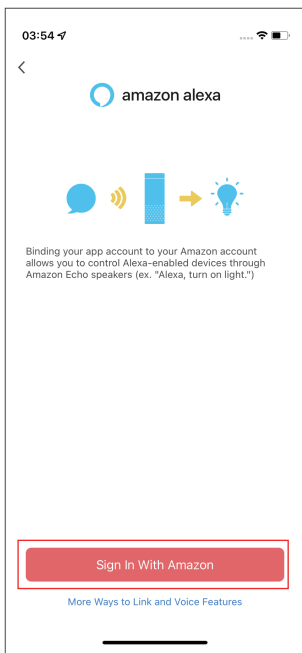
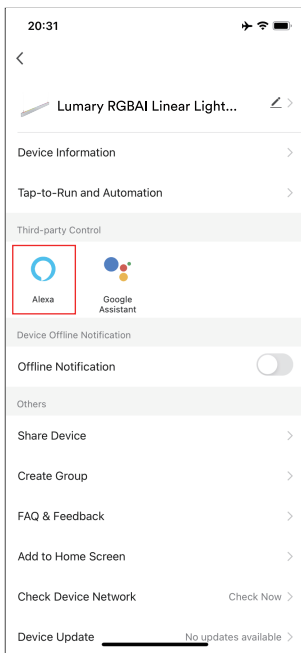

4. Tap "Allow";

5. Linked successfully, when add new device, there is no need to link again, just discover new device in Alexa.

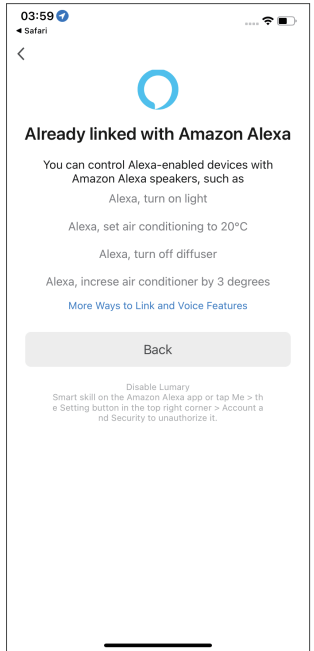
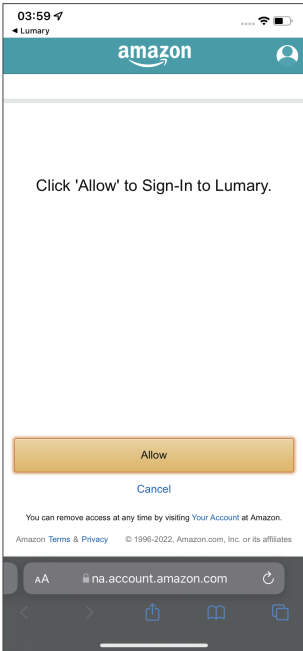



To control your Lumary smart device, just ask Alexa.

Make sure your devices are already set up using the Lumary app.

Things you can say\*:

"Alexa, discover my devices."

"Alexa, turn on the bedroom light."

"Alexa, set the bedroom light to orange."

"Alexa, turn off the coffee machine."

"Alexa, set the living room to 50%."

"Alexa, dim porch light."

\*Some commands require compatible devices.

# Voice Control Quick Guide for Google Assistant

1. Log in to Lumary App, tap the smart device and enter into, click "✎" in the top right corner.
2. Tap "Google Assistant" in Third-party Control.
3. Tap "Link with Google Assistant".

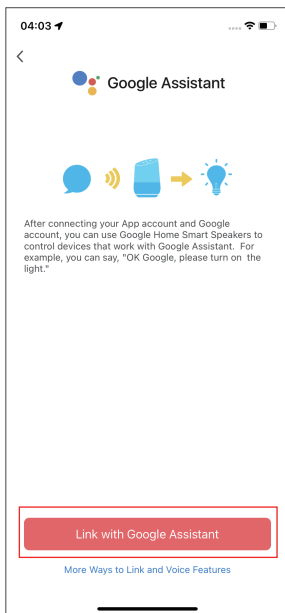
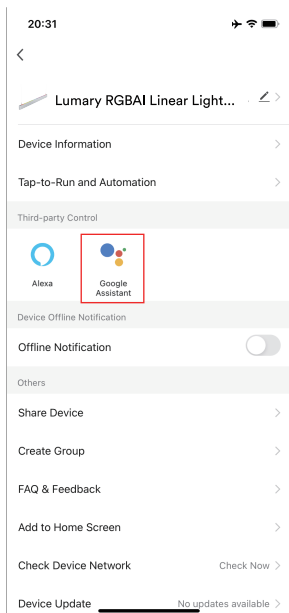

4. Click "Agree and link";

5. Linked successfully, when add new device, there is no need to link again, just discover new device in Google Home.

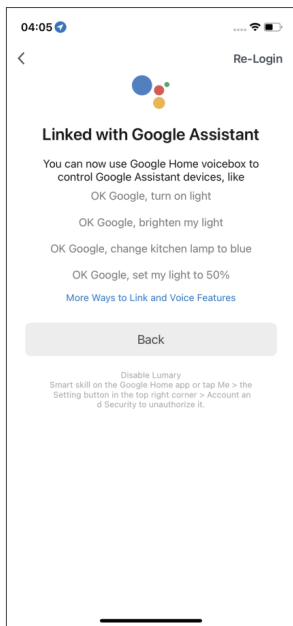
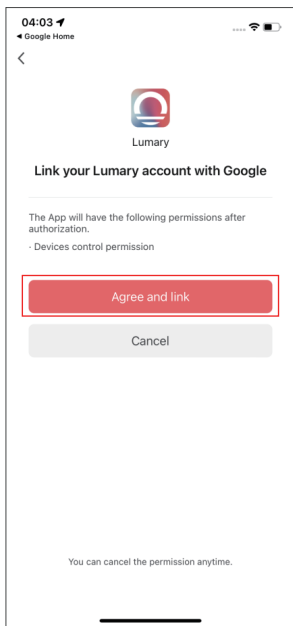



To control your Lumary smart device, just say "Hey Google", and ask.

Make sure your devices are already set up using the Lumary app.

Things you can say\*:

"Hey Google, turn on all the lights in my bedroom."

"Hey Google, turn off the light."

"Hey Google, set the bedroom light to orange."

"Hey Google, turn off the coffee machine."

"Hey Google, set the living room to 50%."

"Hey Google, dim porch light."

\*Some commands require compatible devices.

## After Sales & Social Media

If you have any questions about product settings or operations, please feel free to reach out to us!

Customer Service Email:

support@lumary.tech

You can also find us on social media. Simply search for our username on your preferred platform, or scan the QR code for quick access.

- Facebook: @lumary.official
- X: @lumary\_official
- Instagram: @lumary.official
- Pinterest: @lumary\_official
- YouTube: @lumary.official
- Reddit: @Lumarysmartlight
- TikTok: @lumary.official



Facebook



Instagram



YouTube



TikTok



X



Pinterest



Reddit

Can't connect? Need help?



HAVING AN EASY TALK TO US BEFORE YOU RETURN  
THE PRODUCT WILL FIX A PROBLEM MORE QUICKLY

Lumary support:

[support@lumary.tech](mailto:support@lumary.tech)

Visit us at:

[www.lumary.tech](http://www.lumary.tech)

[www.lumarysmart.com](http://www.lumarysmart.com)