

Installation Manual

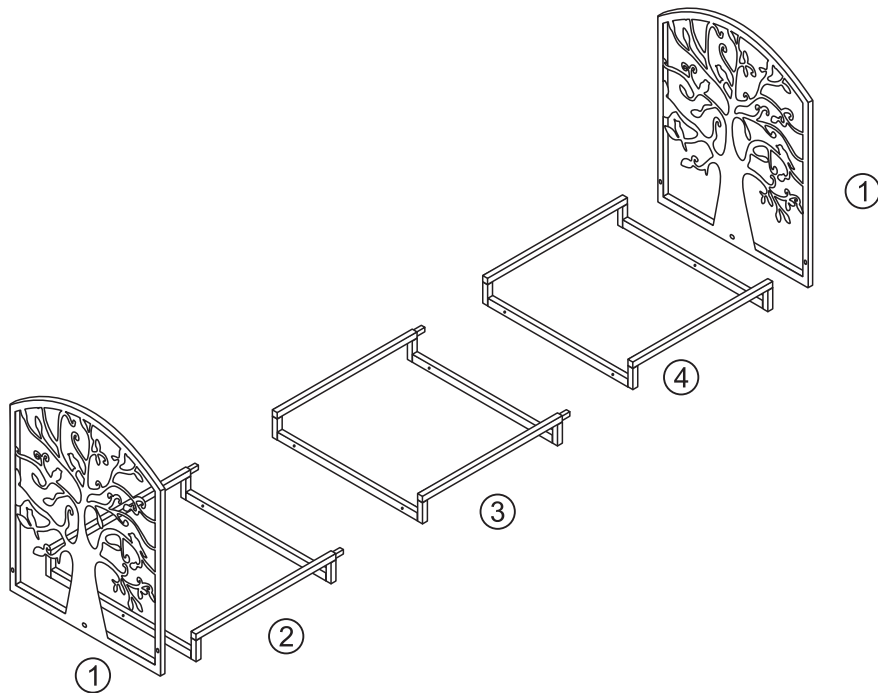

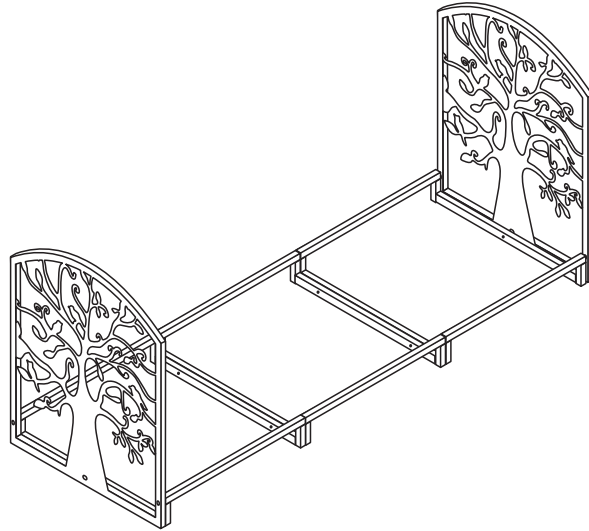

① X2pc

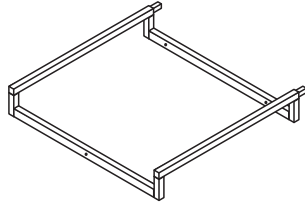

② X1pc

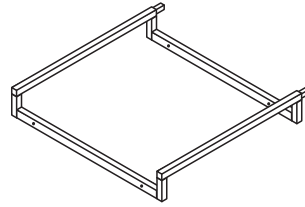

③ X1pc

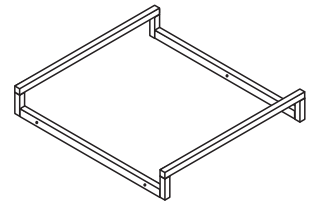

④ X1pc

M8X25



Ⓐ X4pc

M6X35

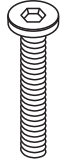

Ⓑ X2pc

M6X30

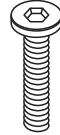

Ⓒ X4pc



Ⓓ X6pc

M6

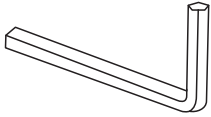



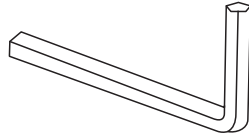

Ⓔ X1pc

M8





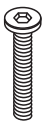

Ⓕ X1pc

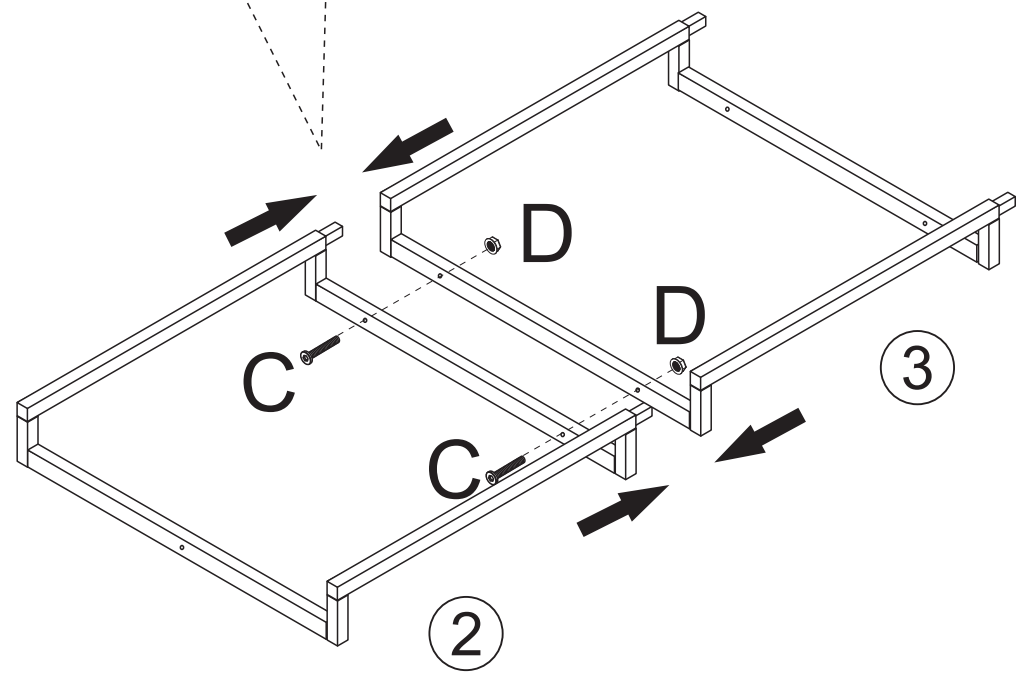
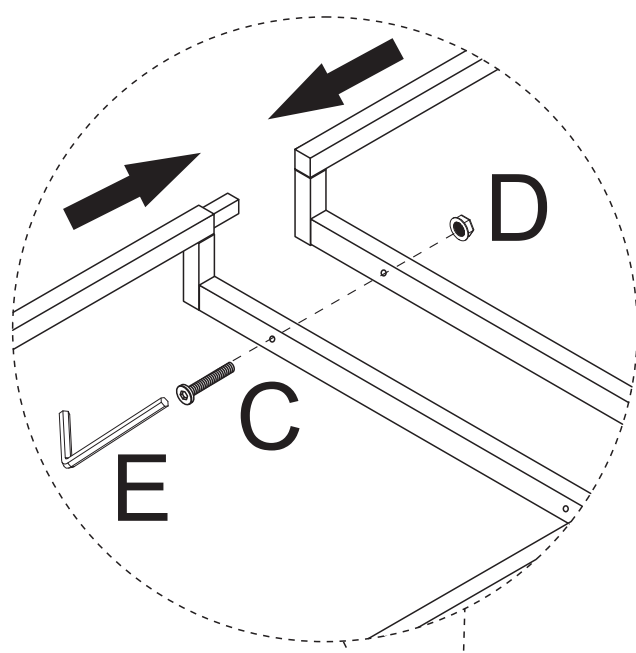
1

 	 ©X2pc	 ⓓX2pc
---	---	--



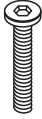

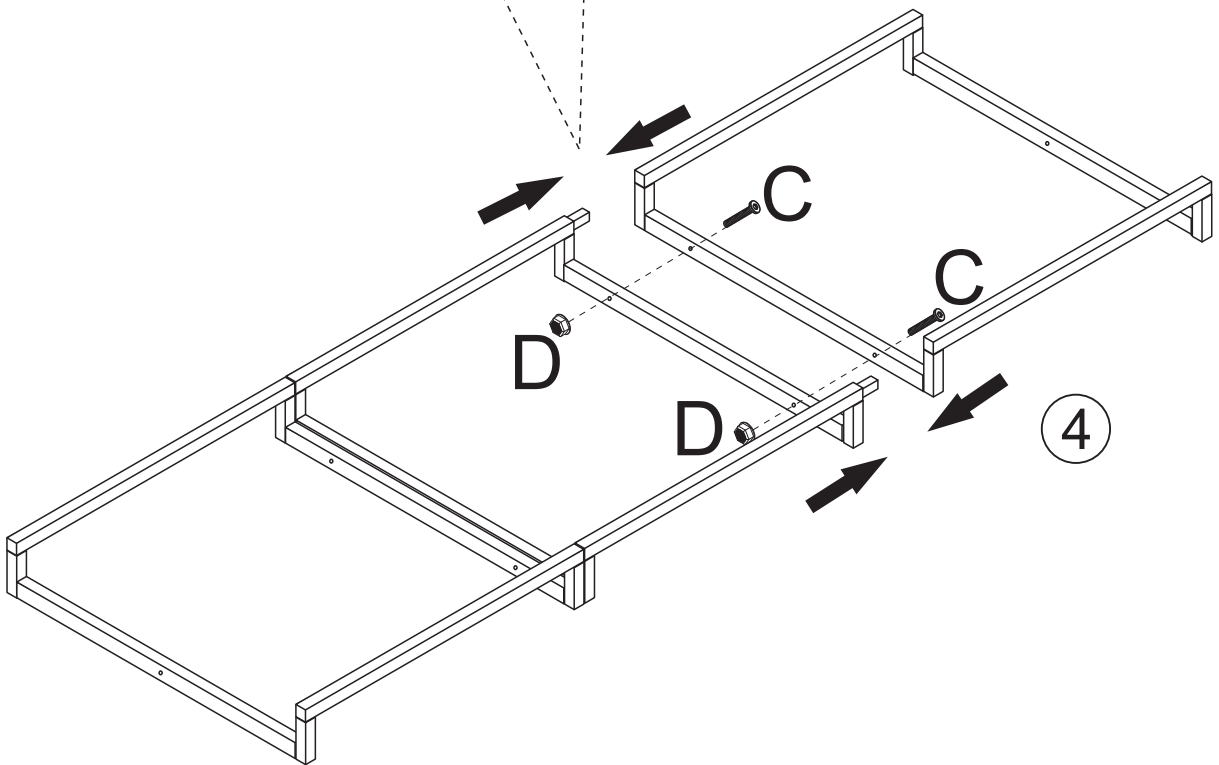
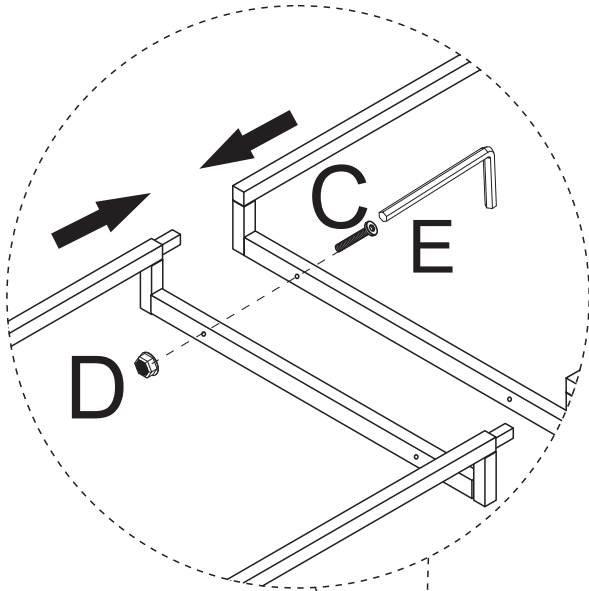

2

 	 ©X2pc	 ⓓX2pc
---	---	--



3

 	 Ⓐ X4pc	 Ⓑ X2pc	 Ⓓ X2pc
---	---	---	---

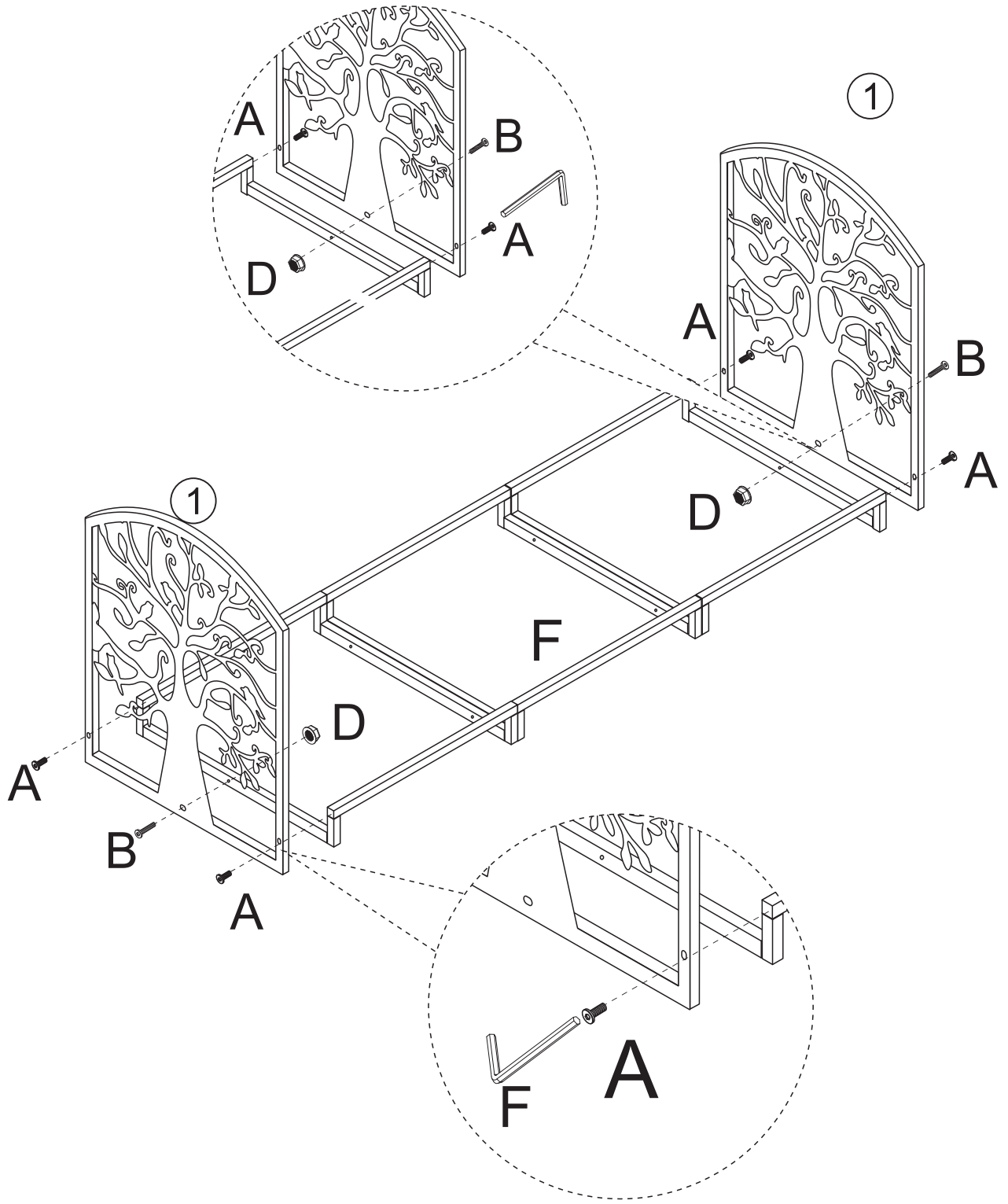



Tighten all screws to 100% after inspection.

