







# ASSEMBLY INSTRUCTION

NO.	PARTS LIST	Q'TY
①	 5/16 *2-1/4 "	5PCS
②	 5/16 *2-1/2 "	4PCS
③	 5/16	9PCS
④	 5/16	9PCS
⑤	 5/16	1PC
⑥	 8*1-3/4	6PCS

NO.	PARTS LIST	Q'TY
A	 CHAIR BACK	1PC
B	 SEAT FRAME	1PC
C	 FRONT LEFT LEG	1PC
D	 FRONT RIGHT LEG	1PC
E	 CROSS BAR	1PC
F	 LEFT STRETCHER	1PC
G	 RIGHT STRETCHER	1PC

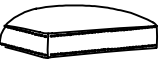
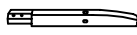
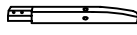
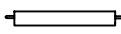
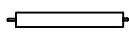
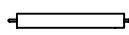
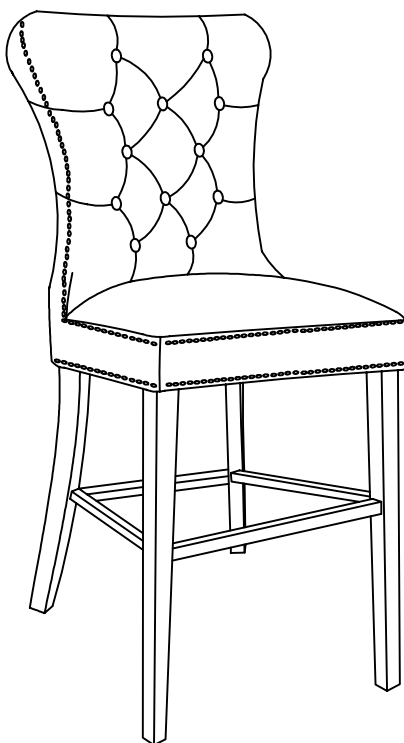

STEP 1

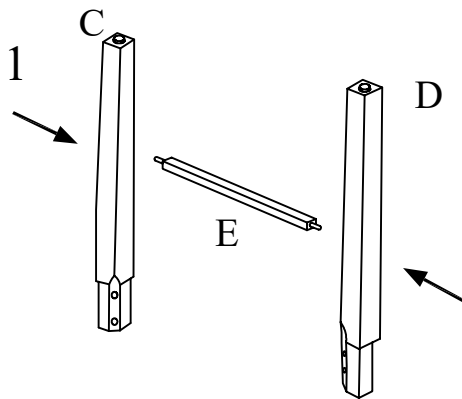

STEP 2

