

OPERATION INSTRUCTIONS

ROUND FRAME SPA

Please do not assemble until receiving the complete 3 packages. If you have not received the complete 3 packages, please be sure to contact us.

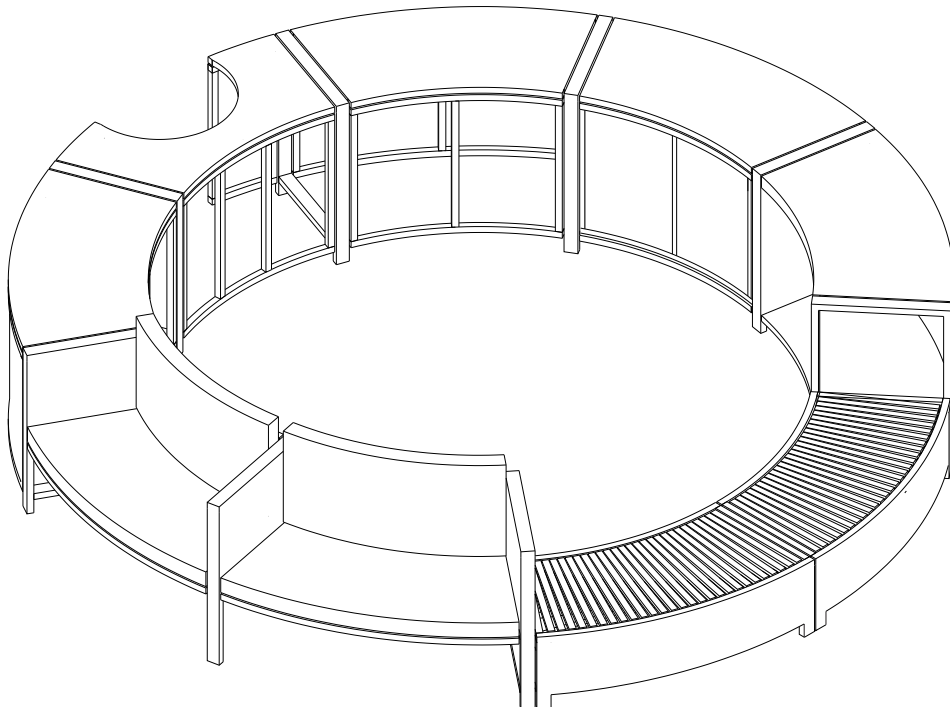

HEALTH CAUTION

- ☒ If you have any concerns regarding to your health, consult your doctor before using this product.
- ☒ Individuals with pacemakers should not use this product.
- ☒ If you have pain in a muscle or joint after using for a prolonged period of time, discontinue using and consult your doctor. Persist pain could be a symptom of a more serious condition.

MAINTAINANCE INSTRUCTIONS

TO STORE:

Place unit in its box or safety dry and cool place. Avoid putting chair in contact with sharp edges or pointed objects which might cut or puncture the fabric. Do not wrap attached power cord around the unit. Do not pull the unit by power cord.

TO CLEAN:

- ☒ Ensure the unit is unplugged from the power source, and allow the unit to cool down before cleaning.
- ☒ Do not use any liquid to clean. Clean fabric cover by wiping with a damp sponge, using a mild detergent or suds. Pat with clean, dry cloth.
- ☒ Do not use any abrasive cleaners, brushes, gasoline, kerosene, glass furniture polish, paint thinner or water hotter than 120° F to clean the unit.

ASSEMBLY INSTRUCTIONS

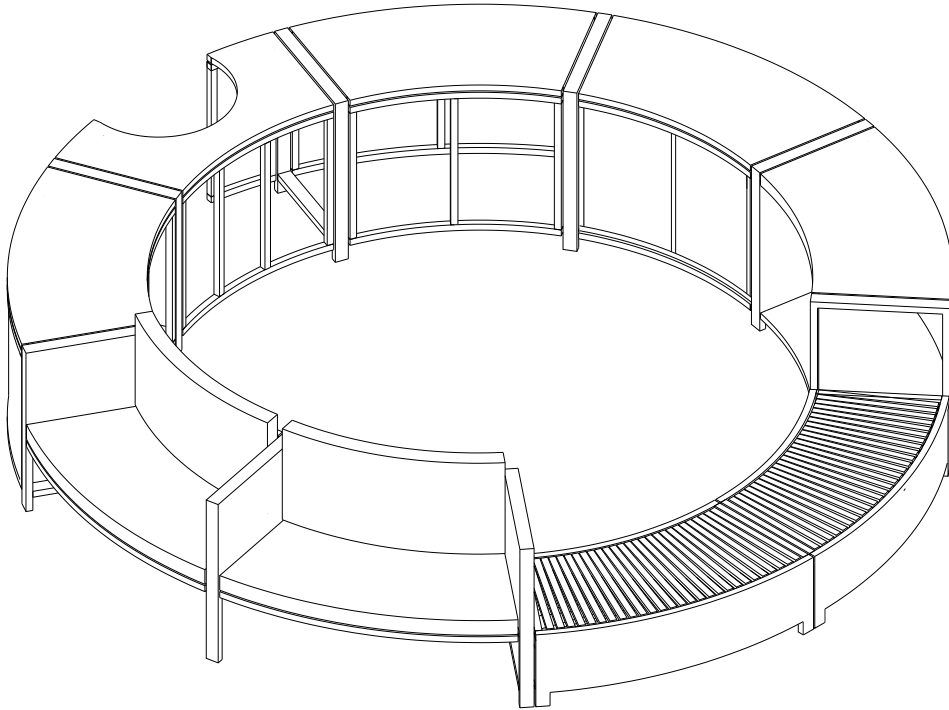



GENERAL ASSEMBLY INFORMATION GUIDE

Please read the following instructions prior to assembling this product:

1. To avoid damage, assemble this product on a non-abrasive surface such as carpet.
2. Make sure all bolts are tightly fastened before use.
3. For home use or light commercial use only.
4. Please make sure you have all parts before assembly.

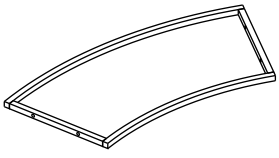
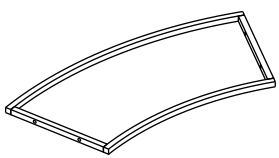
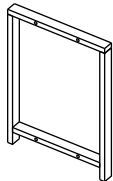
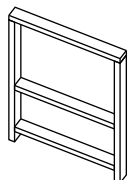
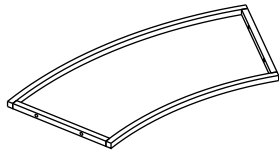
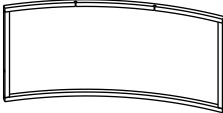
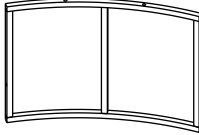
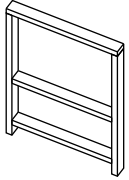
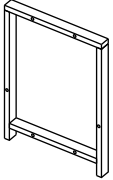
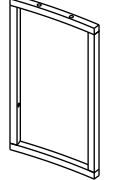
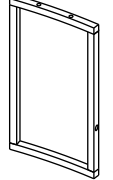
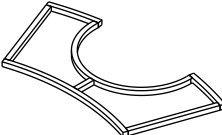
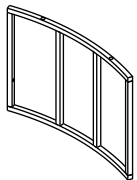
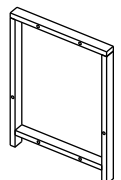
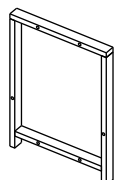
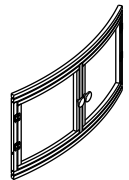
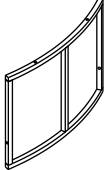
PARTS LIST

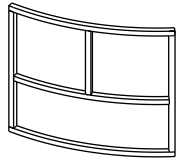
A  QTY 1 pc	B  QTY 2 pcs	C  QTY 1 pc	D  QTY 1 pc
E  QTY 3 pcs	F  QTY 2 pcs	G  QTY 2 pcs	H  QTY 1 pc
I  QTY 2 pcs	J  QTY 1 pc	K  QTY 1 pc	L  QTY 1 pc
M  QTY 1 pc	N  QTY 1 pc	O  QTY 1 pc	P  QTY 1 pc
Q  QTY 1 pc	R  QTY 1 pc	S  QTY 1 pc	T  QTY 2 pcs

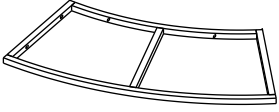
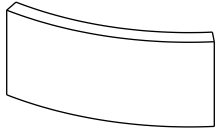
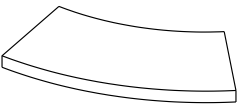
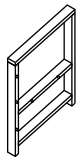

U	W	V	X
			
QTY 2 pcs	QTY 2 pcs	QTY 2 pcs	QTY 1 pc

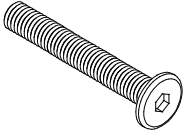
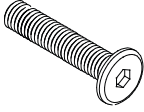
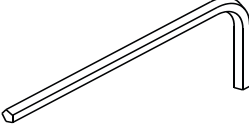
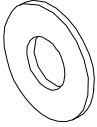
HARDWARE

<p>1</p>  <p>Bolt M6x60mm QTY 6 pcs</p>	<p>2</p>  <p>Bolt M6x40mm QTY 82 pcs</p>	<p>3</p>  <p>QTY 2 pcs</p>	<p>4</p>  <p>QTY 88 pcs</p>
---	--	---	---

CARTON CONTENT

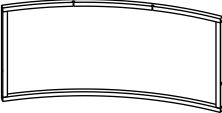
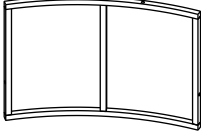
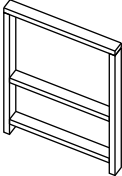
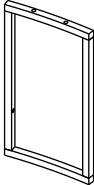
WF318650

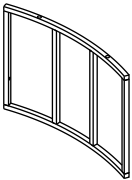
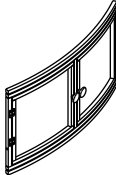
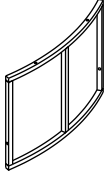
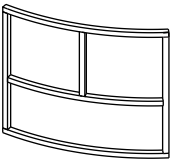
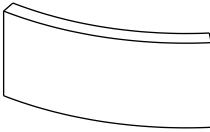

F  QTY 2 pcs	G  QTY 2 pcs	H  QTY 1 pc	J  QTY 1 pc
K  QTY 1 pc	M  QTY 1 pc	P  QTY 1 pc	Q  QTY 1 pc
T  QTY 2 pcs	W  QTY 2 pcs		

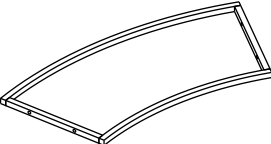
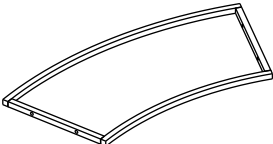
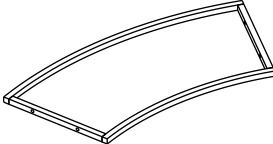
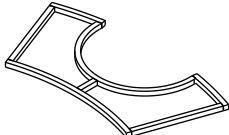
WF318656

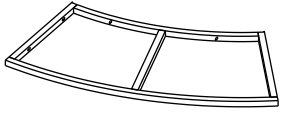
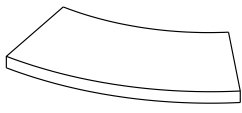
A  QTY 1 pc	B  QTY 2 pcs	E  QTY 3 pcs	L  QTY 1 pc
---	--	---	---

<p>U</p>  <p>QTY 2 pcs</p>	<p>V</p>  <p>QTY 2 pcs</p>
--	--

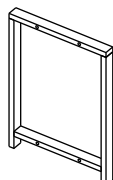
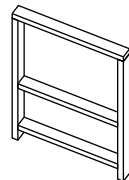
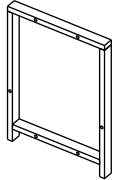
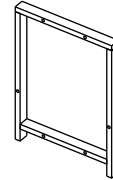
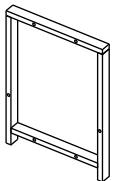

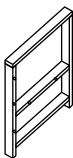
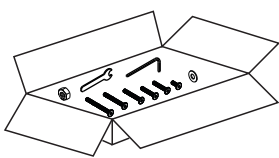
WF318657

<p>C</p>  <p>QTY 1 pc</p>	<p>D</p>  <p>QTY 1 pc</p>	<p>I</p>  <p>QTY 2 pcs</p>	<p>N</p>  <p>QTY 1 pc</p>
<p>O</p>  <p>QTY 1 pc</p>	<p>R</p>  <p>QTY 1 pc</p>	<p>S</p>  <p>QTY 1 pc</p>	<p>X</p>  <p>QTY 1 pc</p>
<p>HARDWARE</p> 			

STEP 1

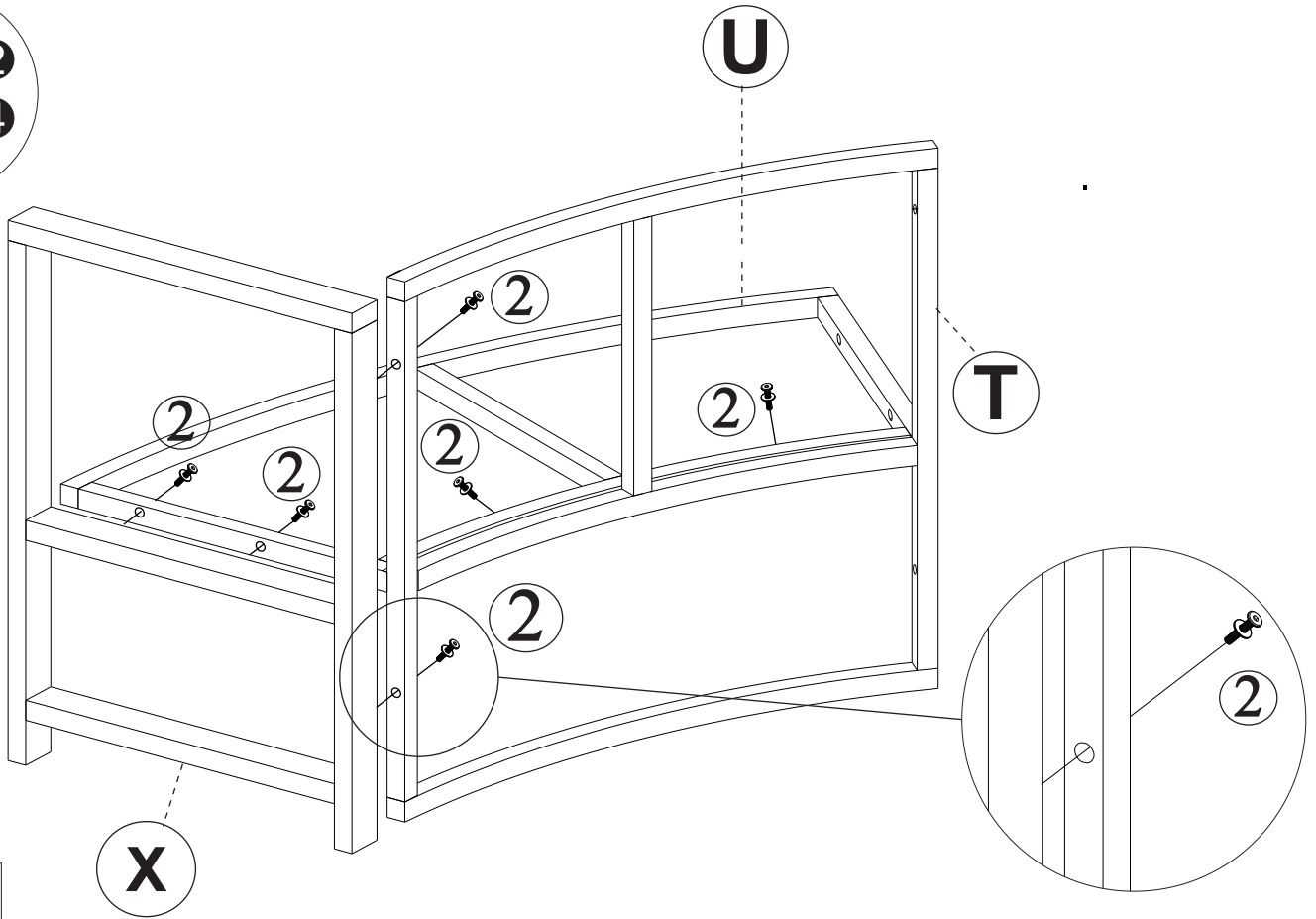
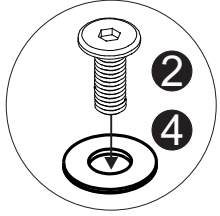
Connect parts (U), (X), (T) and using bolt (2)





	
6 pcs	6 pcs

STEP 2

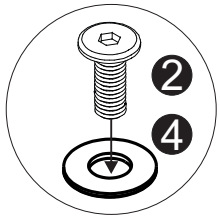
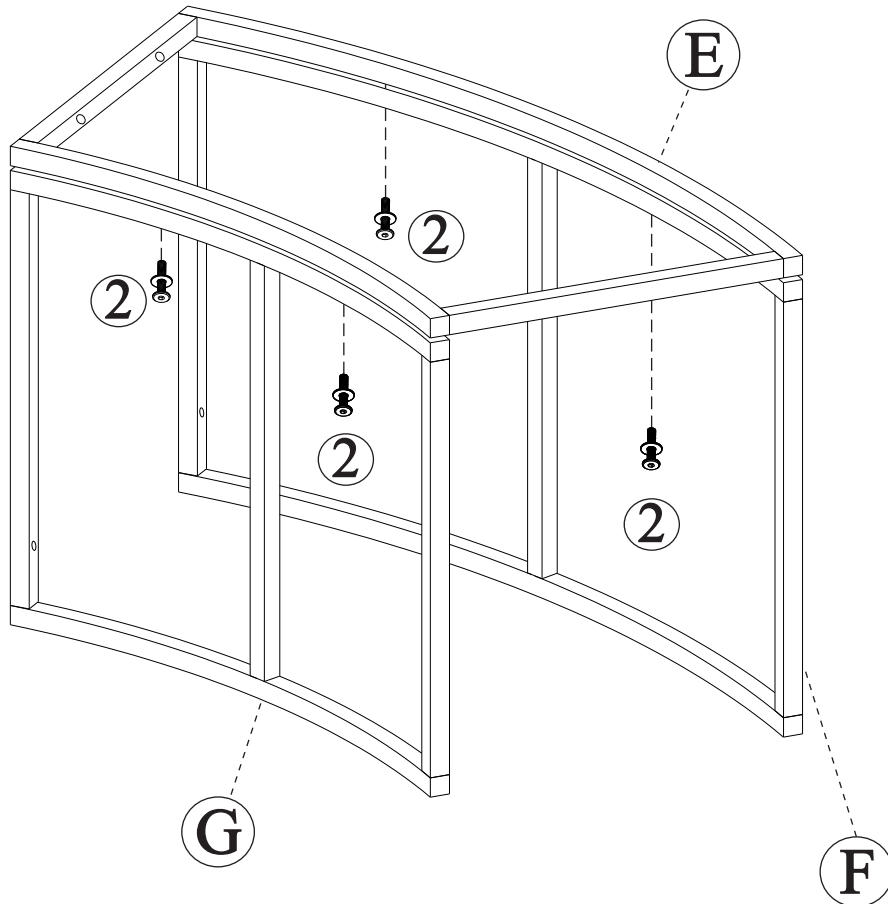
Connect parts (E), (F), (G) and using bolt (2)



	
4 pcs	4 pcs

STEP 3

Connect step 1, step 2, parts (D), (H), (T), (U) and using bolt (2)

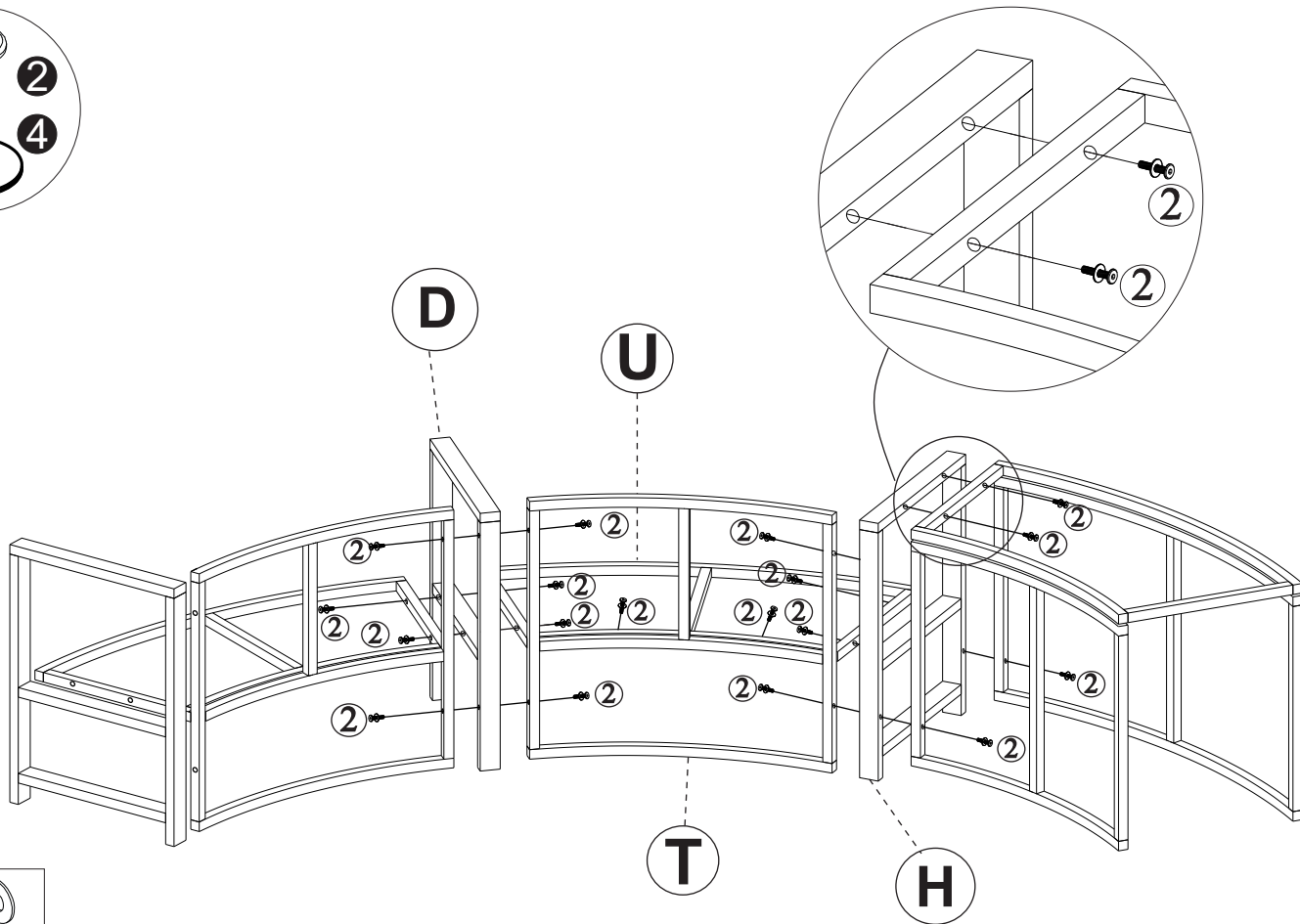
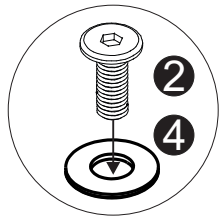

2	4
18 pcs	18 pcs

STEP 4

Connect parts (I), (J), (K), (L), (M) and using bolt (2)

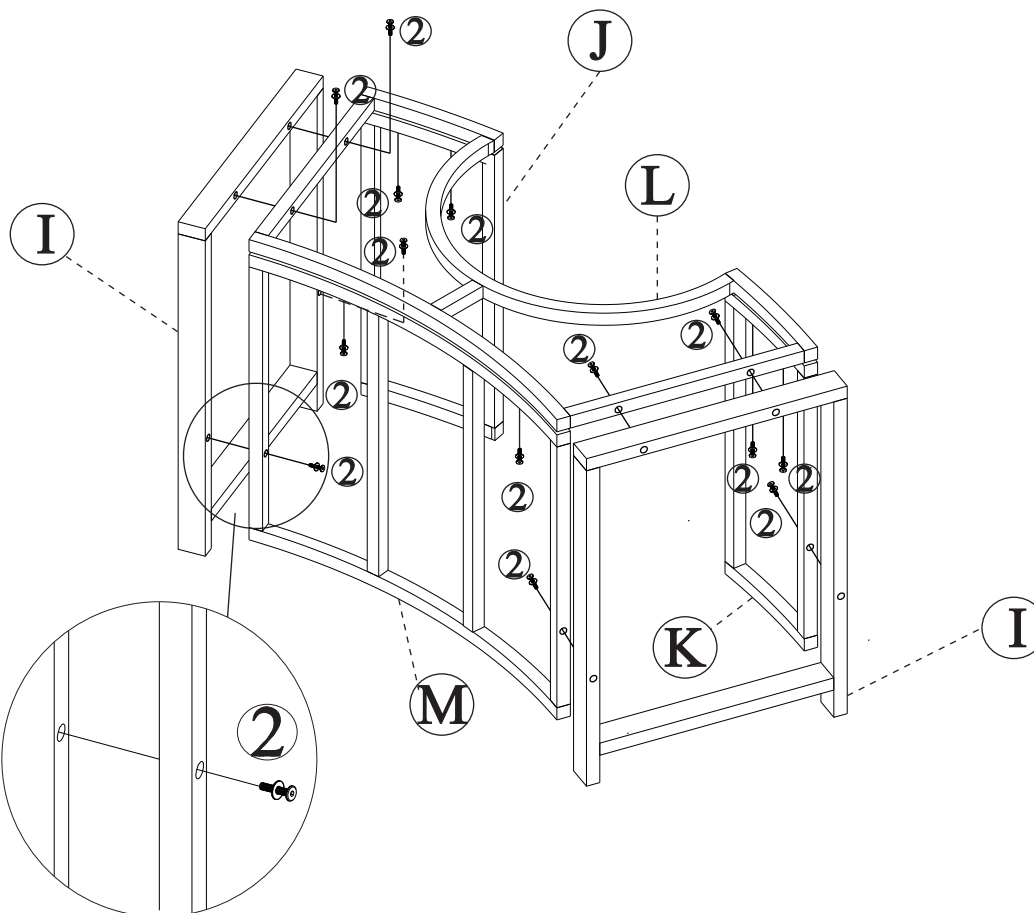

2	4
14 pcs	14 pcs

STEP 5

Connect parts (A), (B), (C) and using bolt (2)

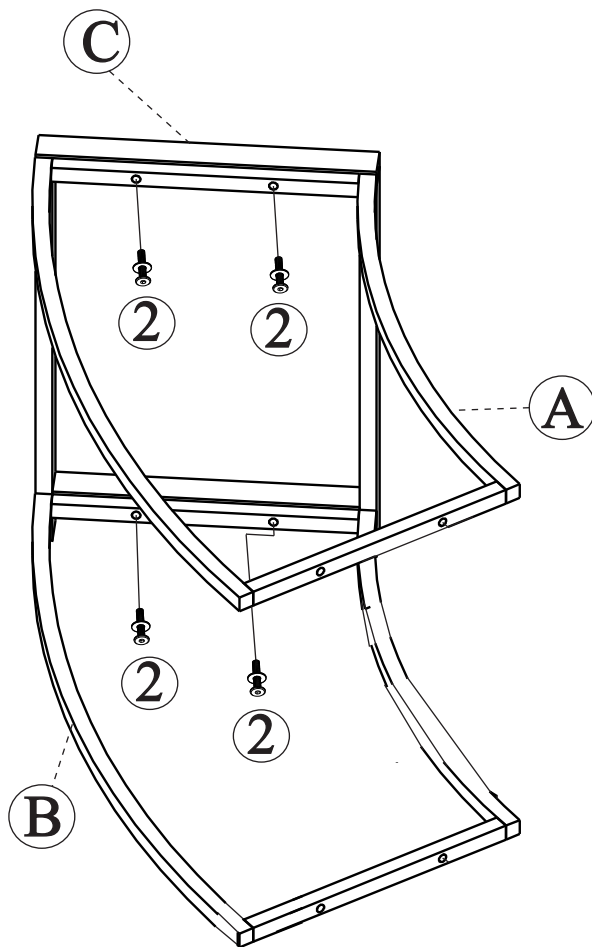
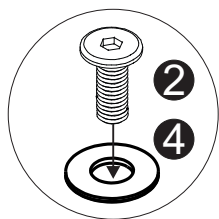

2	4
4 pcs	4 pcs

STEP 6

Connect parts (E), (F), (G) and using bolt (2)

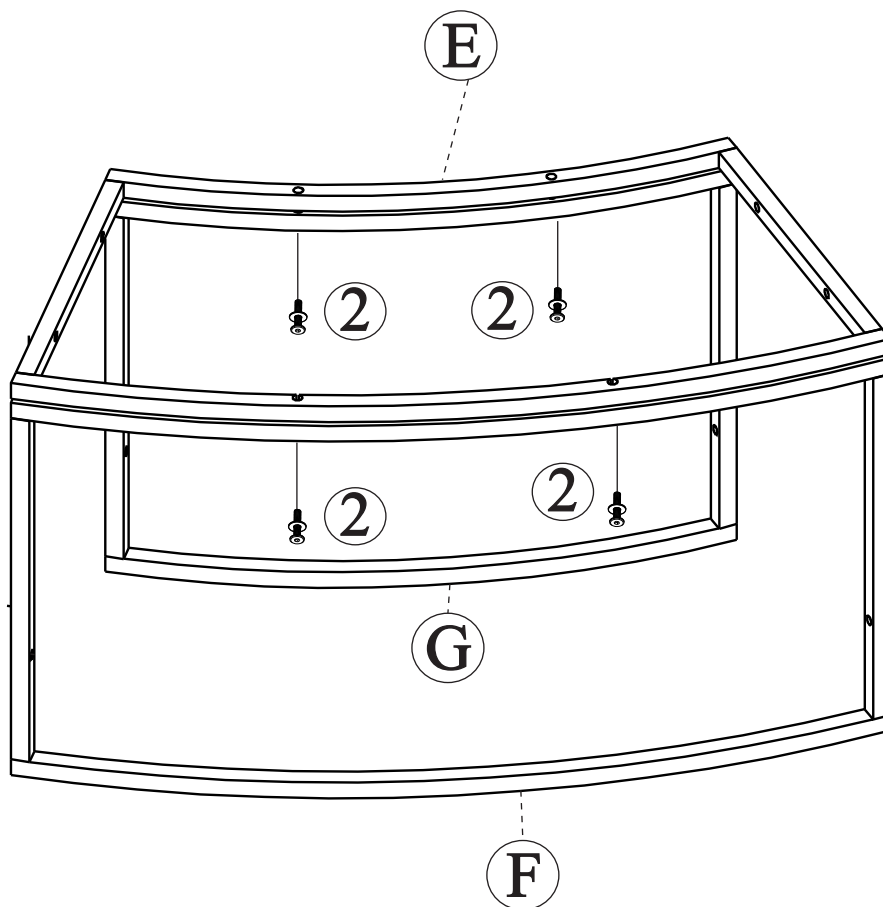
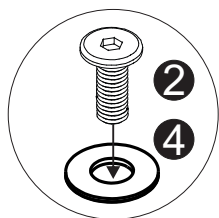

2	4
4 pcs	4 pcs

STEP 7

Connect parts (E), (P), (Q) and using bolt (2)

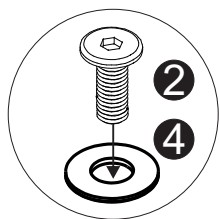
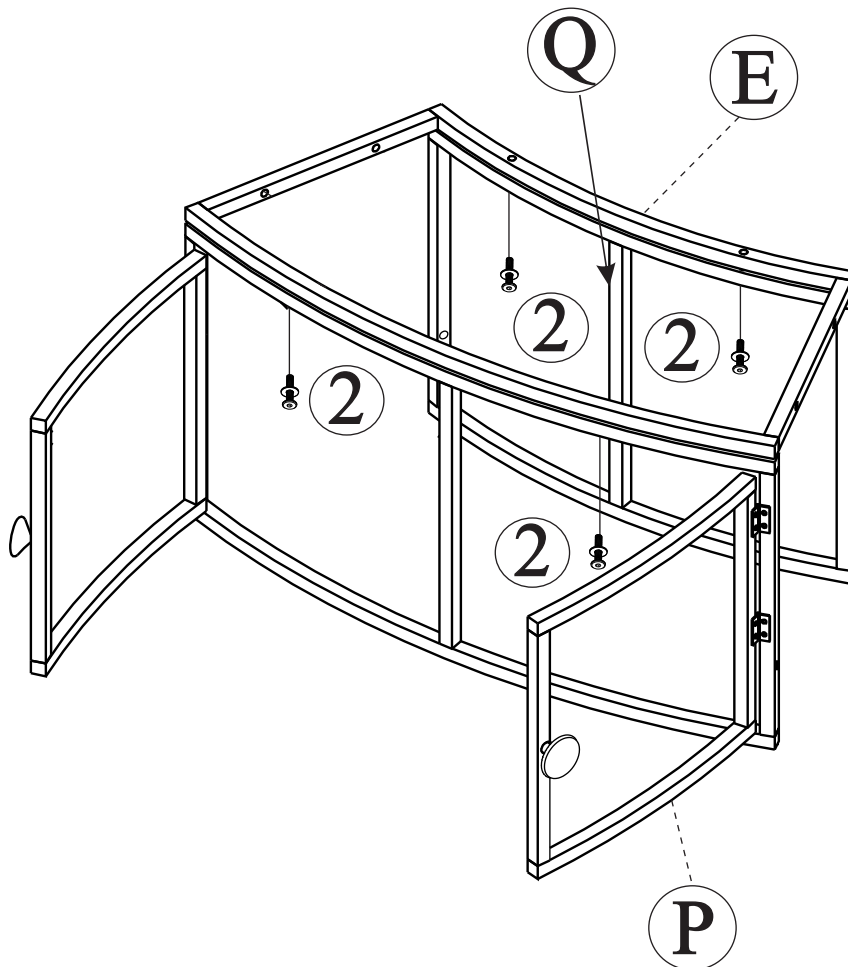

2	4
4 pcs	4 pcs

STEP 8

Connect step 5, step 7, part (O), parts (B) and using bolt (2)

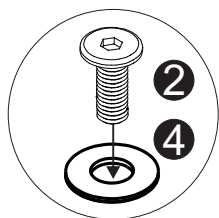
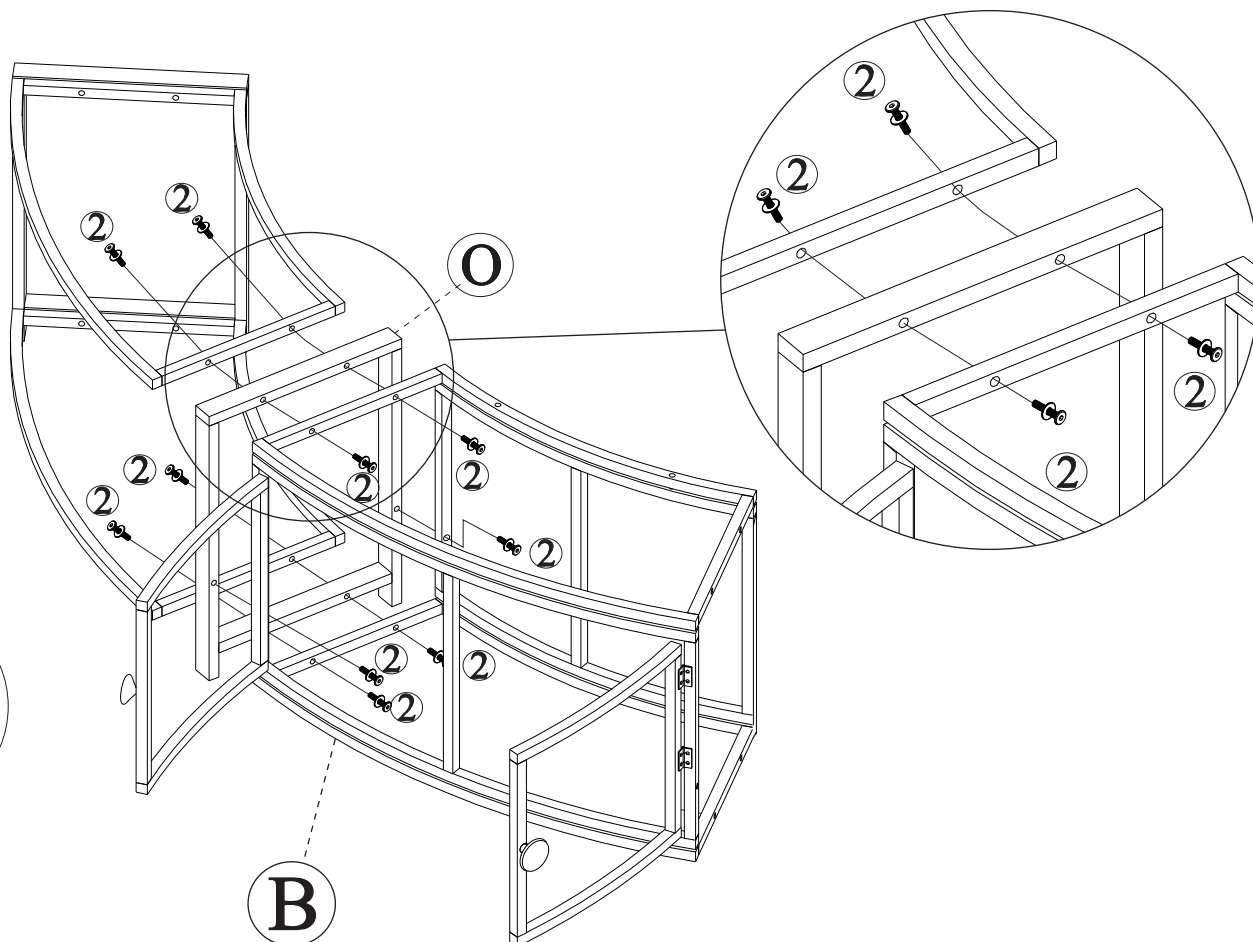

2	4
10 pcs	10 pcs

STEP 9

Connect step 6, step 8, part (N) and using bolt (2)

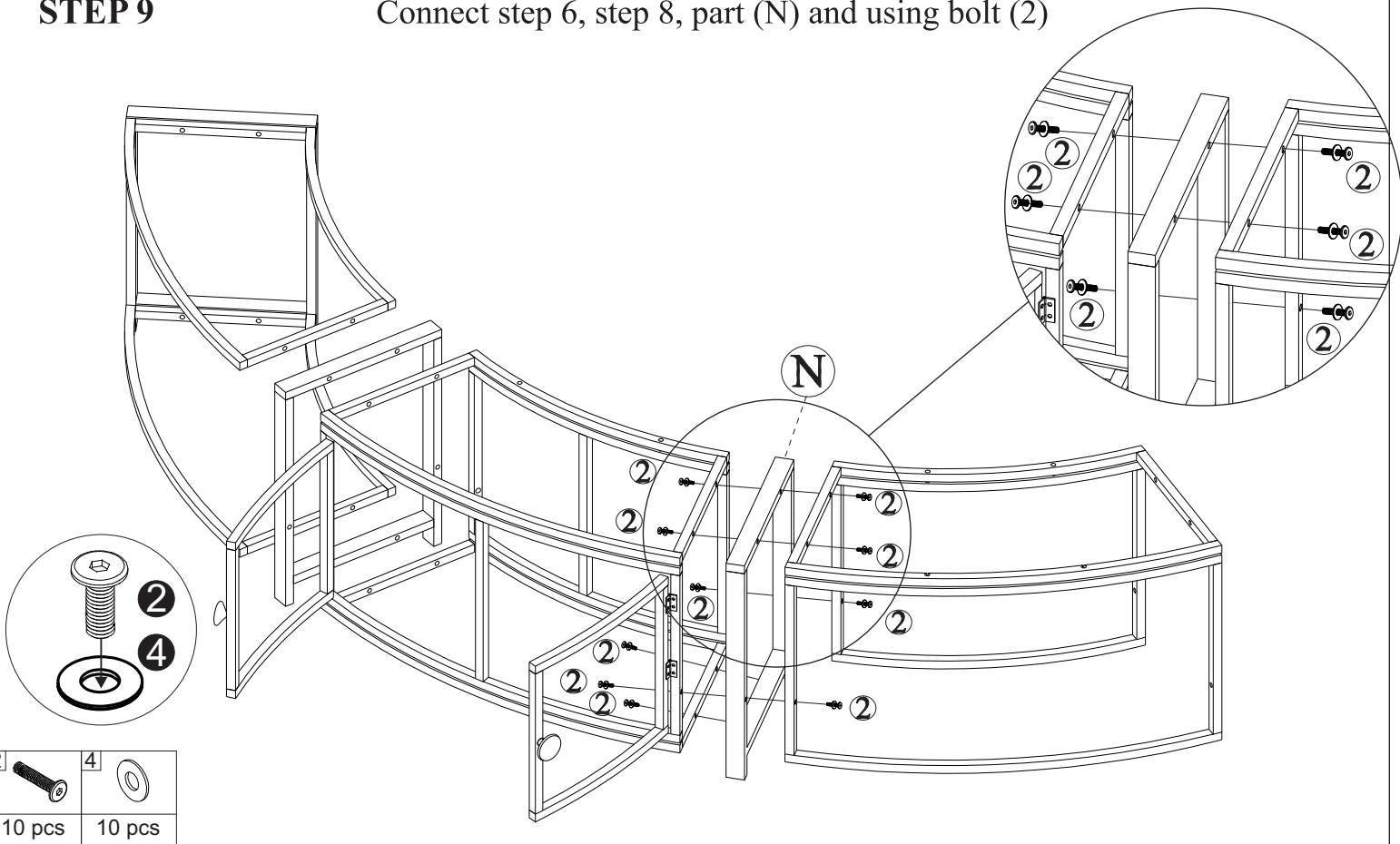

STEP 10

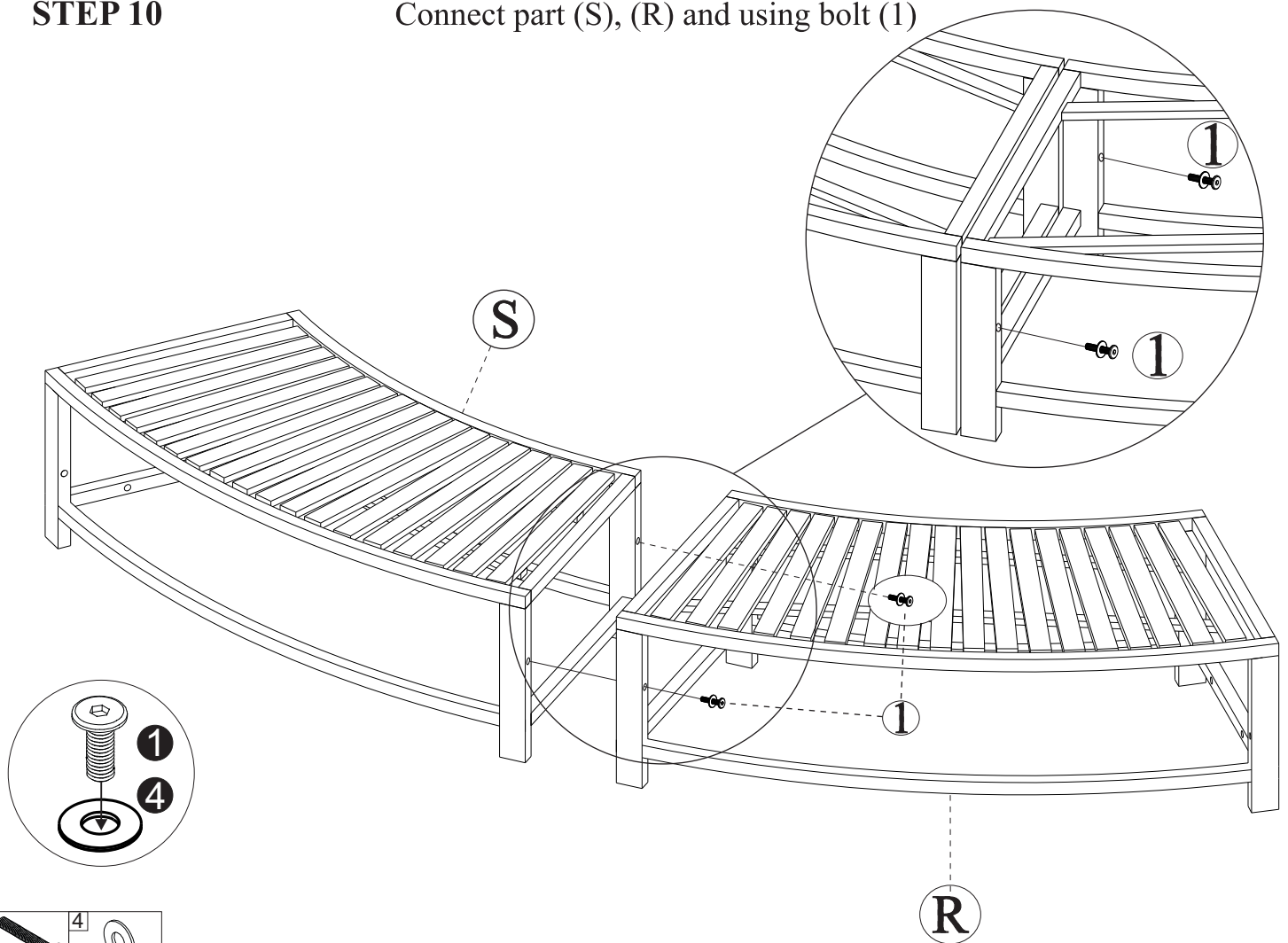

Connect part (S), (R) and using bolt (1)

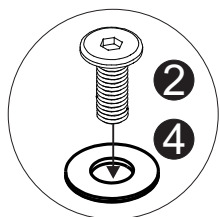
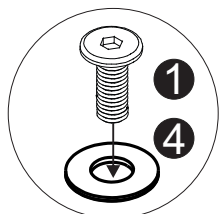
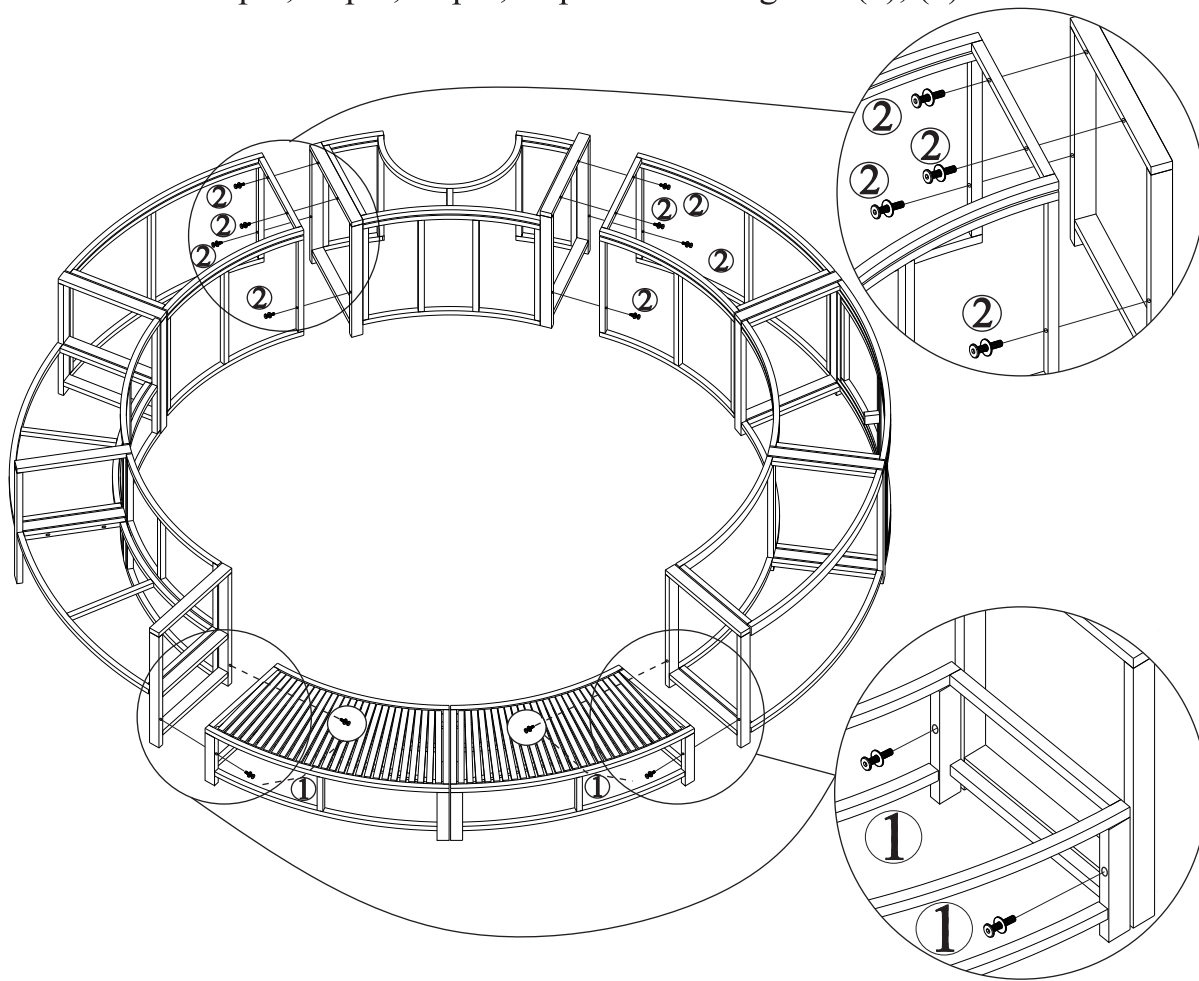

STEP 11

Connect step 3, step 4, step 9, step 10 and using bolt (1), (2)



		
4 pcs	8 pcs	12 pcs

STEP 12

Connect part (V), (W), step 11

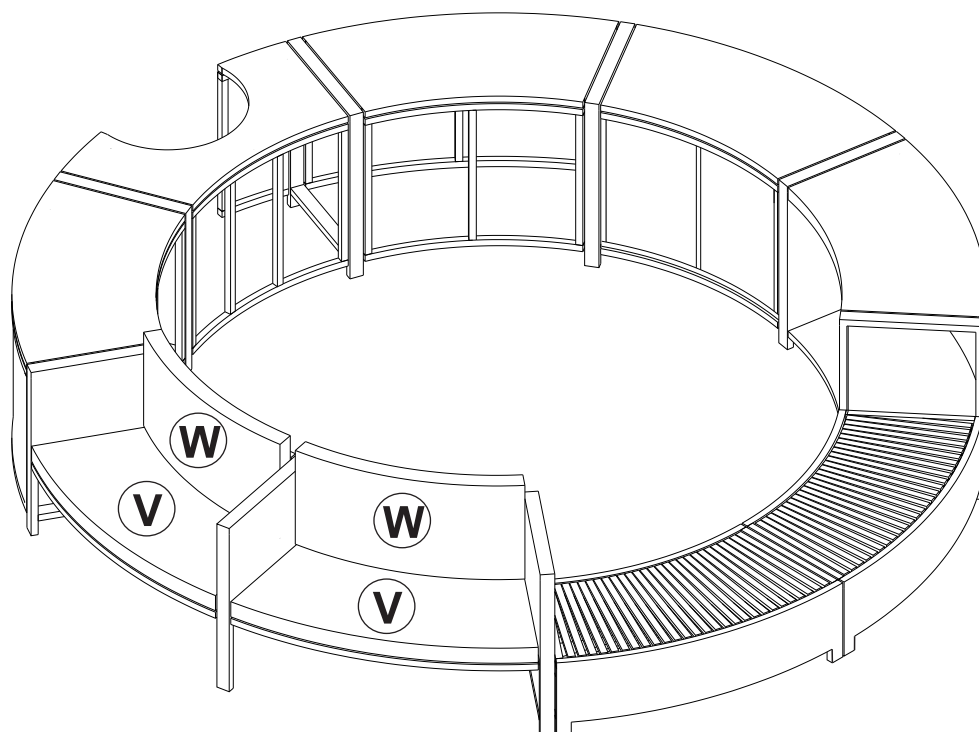

WARNINGS

- ☒ Sit down in the chair gently. To avoid tipping over, do not throw yourself into the chair. Move the chair into the reclining position slowly, making sure that no children or pets are in close proximity. Do not allow children to play on or around the chair, particularly when it is in an open position.
- ☒ Close the recliner completely before getting out of it.
- ☒ Never sit on the footrest when it is open, even if it is a child.
- ☒ To eliminate the risk of tipping over, do not sit on the arms or footrest of the chair.
- ☒ This chair is designed to be used by 1 adult at a time.
- ☒ Maximum weight capacity is 330LBS, do not allow any person who over 330LBS to sit on the recliner.
- ☒ Please forbid people with the following ailments from using this sofa:
Those people with severe symptoms of heart disease, high blood pressure, cerebral thrombosis and others who are sensitive to heat or completely insensitive to heat, those with brittle bones or have issues with waist support pregnant women, children and others where it has been determined they are not suitable to use this product under the

guidance of doctors.

- ☒ To fully recline the sofa, ensure the sofa well, you need to put the sofa at least 100cm away from the wall or any other obstacle.
- ☒ Product cannot touch water, fire, etc. Product can also not come in contact with sharp objects (knives, nails, etc.)

MAINTENANCE MANUAL INSTRUCTIONS

- ☒ To avoid dropping, you should carry the sofa carefully.
- ☒ If you find dirt and or stains on the chair, spray the sofa with a sofa specific cleaner then use a sponge or cloth to wipe the dirt away. Do not use water, soapy water or cleaner with waxed wooden areas. Take care to wipe the sofa carefully and gently.
- ☒ Do not put the sofa in an area with direct sunlight and do not put the sofa directly in front of an air conditioner, this will fade the upholstery and make it brittle.