	<p>20'</p>
 		
		<p>1</p>

A

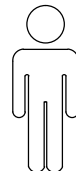

x 1

B

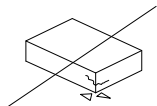
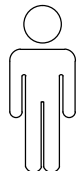
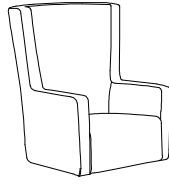

x 4

A

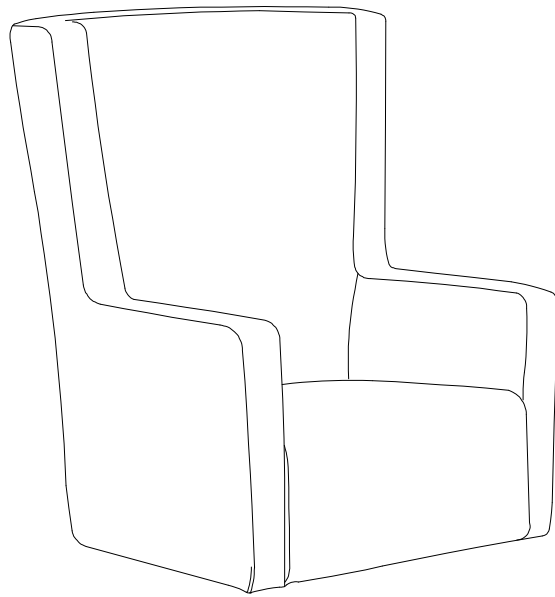

B x 4

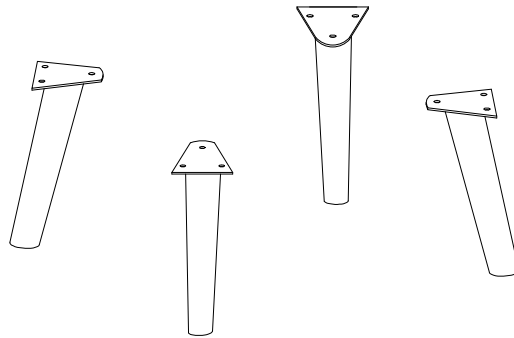

C

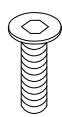

**M6
x
20**

x 12

D

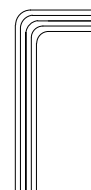

x 1

1

