







## CARE AND MAINTENANCE

Store outdoor furniture indoors or cover well when not in use.  
 Remove wicker furniture from standing water. Dust regularly with small brush or vacuum  
 Spills should be taken care of immediately before they harden or stain with a slightly dampened sponge.

## NOTICE

- \* Please make sure that you have all parts indicated before you begin assembly of this item
- \* This item should be assembled on a soft surface to prevent scratching the finish during assembly
- \* This item may require periodic tightening

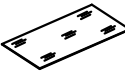
### Part List and Hardware List

PIECE	DESCRIPTION	PICTURE	QUANTITY
A	<b>Chair Seat Frame</b>		2X
B	<b>Chair Leg - 1</b>		2X
C	<b>Chair Seat Cushion</b>		2X
D	<b>Chair Back Cushion</b>		2X
E	<b>Table Leg</b>		1X
F	<b>Glass Table</b>		1X
HW1	<b>Socket Screws 6x0.5x15mm</b>		12X
HW2	<b>Allen key</b>		2X

**Weight Capacity : 275 Lbs (chair)  
 550 Lbs (bench)**

**Warning : Do not stand on table**

**Warning : Do not over torque bolts/screws**



Model# PAT7521 - 1/2

Product Dimensions:

23.62"x26.38"x29.13" H (Chair)

39.37"x25.59"x14.96" H (Table)

26.38"x26.38"x29.13" H (Corner)

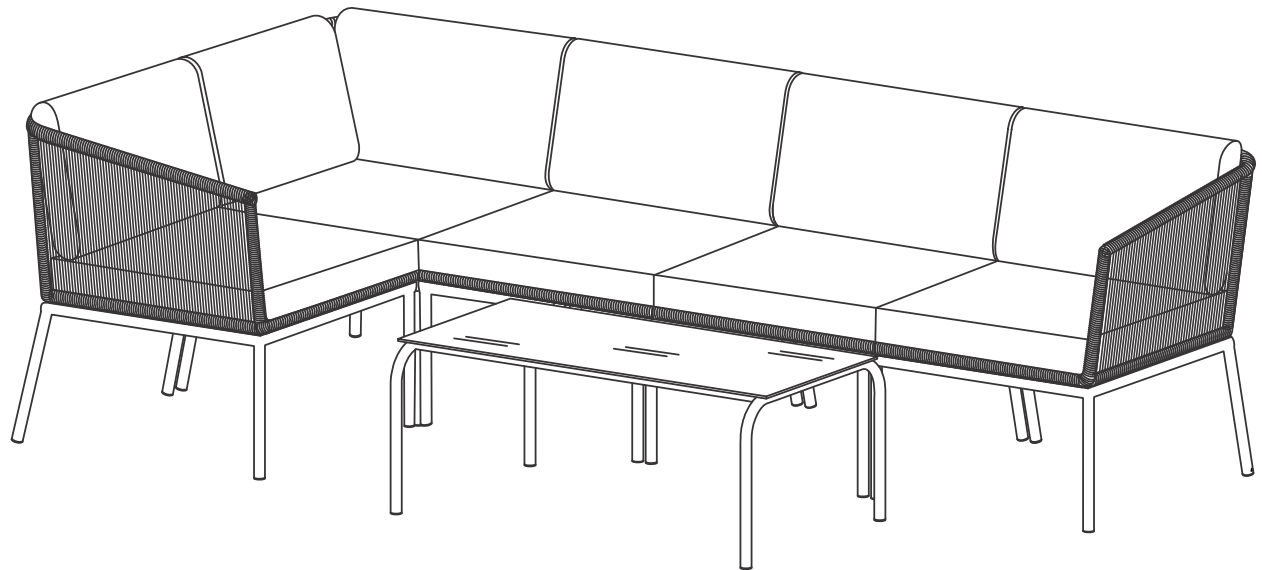



## CARE AND MAINTENANCE

Store outdoor furniture indoors or cover well when not in use.  
Remove wicker furniture from standing water. Dust regularly with small brush or vacuum  
Spills should be taken care of immediately before they harden or stain with a slightly dampened sponge.

## NOTICE

- \* Please make sure that you have all parts indicated before you begin assembly of this item
- \* This item should be assembled on a soft surface to prevent scratching the finish during assembly
- \* This item may require periodic tightening

## Part List and Hardware List

PIECE	DESCRIPTION	PICTURE	QUANTITY
E	Table Leg		1X
F	Glass Table		1X

**Weight Capacity : 275 Lbs (chair)  
550 Lbs (bench)**

**Warning : Do not stand on table**

**Warning : Do not over torque bolts/screws**



## PREPARATION

Before beginning assembly of product, make sure all parts are present. Compare parts with package contents list and hardware contents list.

If any part is missing or damaged, do not attempt to assemble the product.

Estimated Assembly Time: 15 minutes.

Tools Required for Assembly (included): Allen Key

1

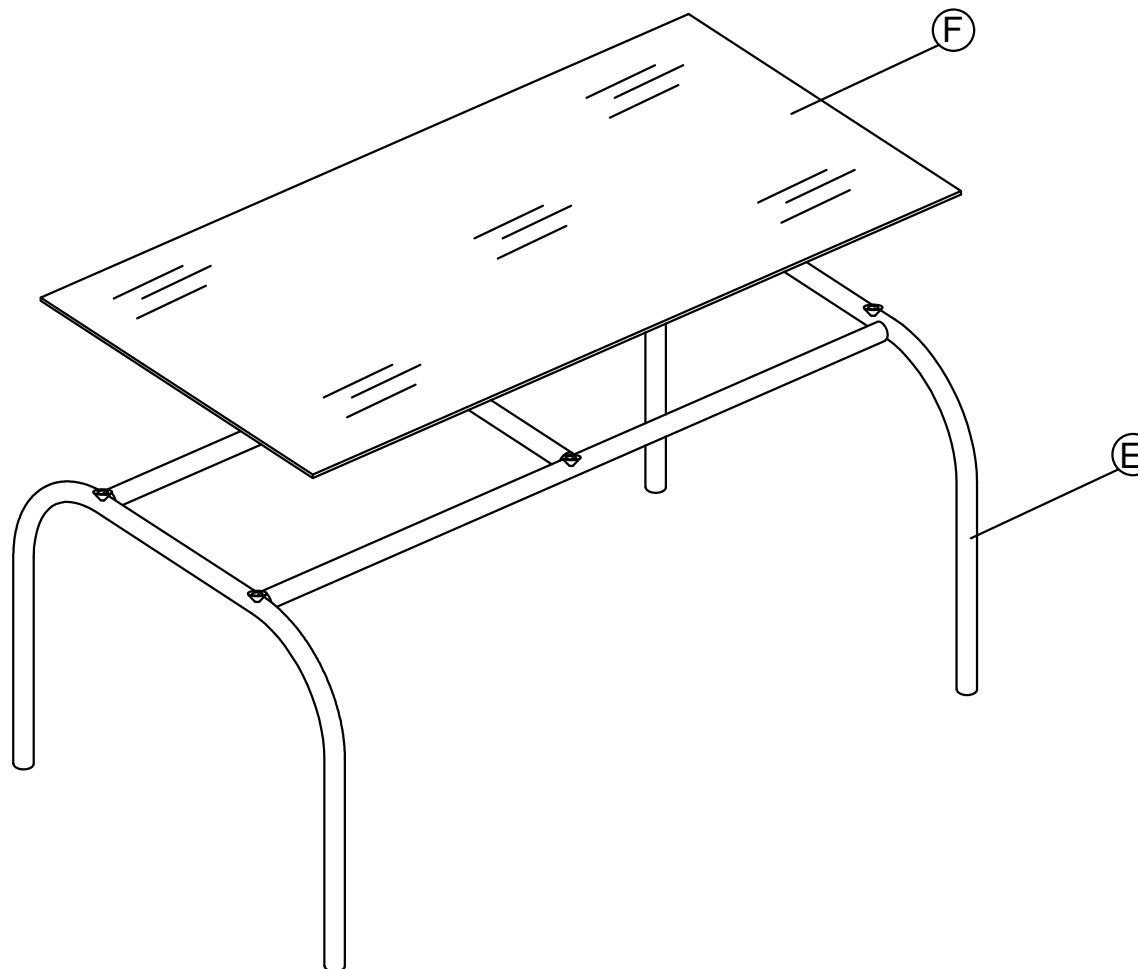

Step 1

Put on Glass Table (F) to complete Table

Caution: This table can only be used on a flat, level surface