

Assembly Instructions

Caution: You must read this before you proceed

Loveseat

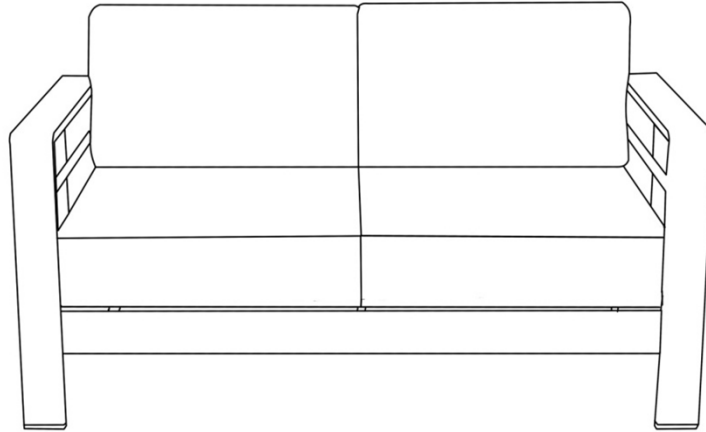

Parts List

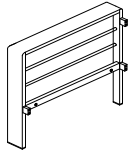
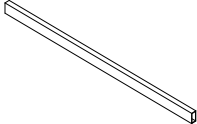
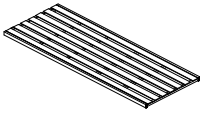
Label	Picture	Description	QTY
A		Side Panel	2
B		Back Support Bar	1
C		Seat (Labelled with face and bottom)	1

Hardware

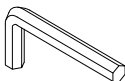
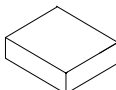
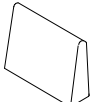
Label	Picture	Description	QTY
D		Bolt:M6*20MM	11
E		Allen Key	1
F		Seat Cushion	2
G		Back Cushion	2

Assembly Preparation

Before Beginning Assembly:

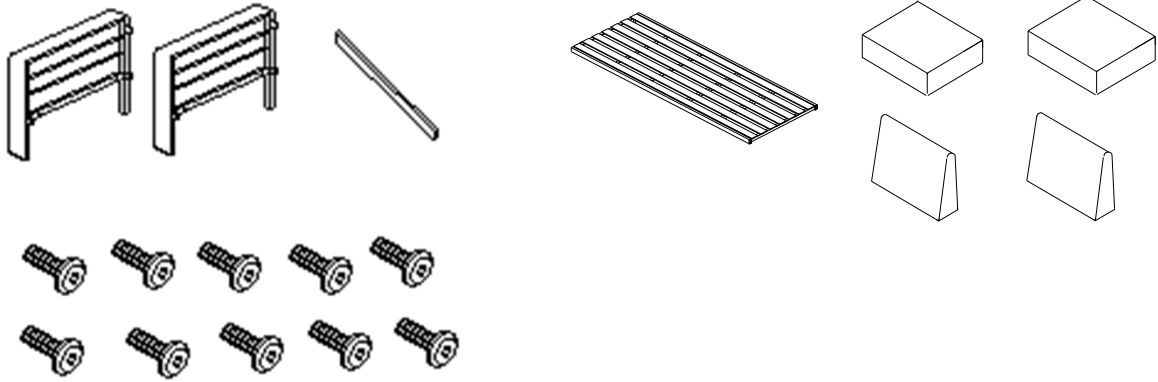

- Read instructions, cover to cover-



- Have 2 adults on hand for assembly-



- Do not assemble on flooring or carpet-



- Assemble on a clean non-marring surface (packing foam)-



- Save all packaging until finished-

Assembly Steps

Step 1

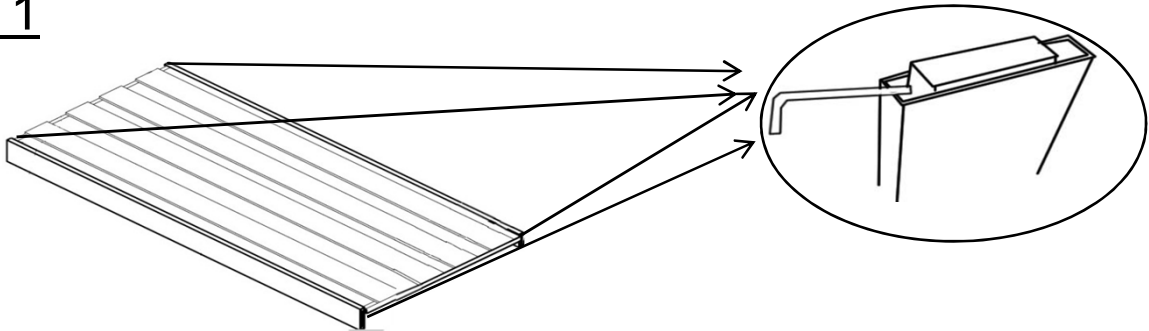

Take out the sliders in the four ends of the Seatboard(C) using Allen Key(E).

Step 2

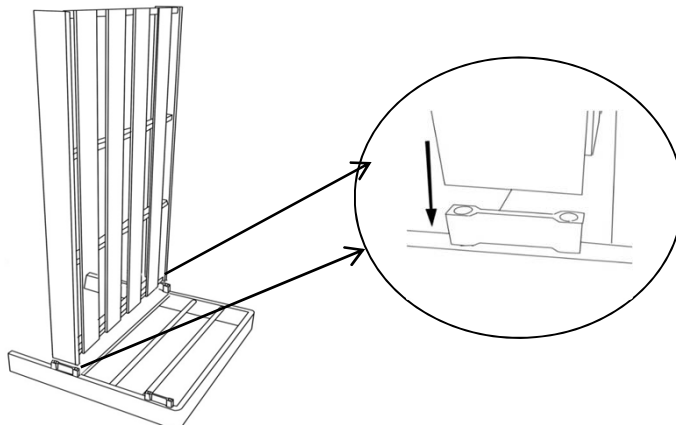

Open the carton and place all the parts on a clean, non-marring surface.
Insert the Seat(C) into the Side Panel(A), shown as the picture.

Step 3

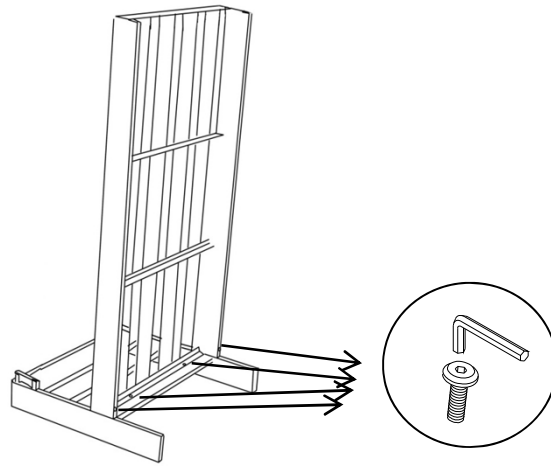

Attach Seat(C) and Side Panel(A) using Bolt(D) and Allen Key(E).
Loosely tighten the Bolts.

Step 4

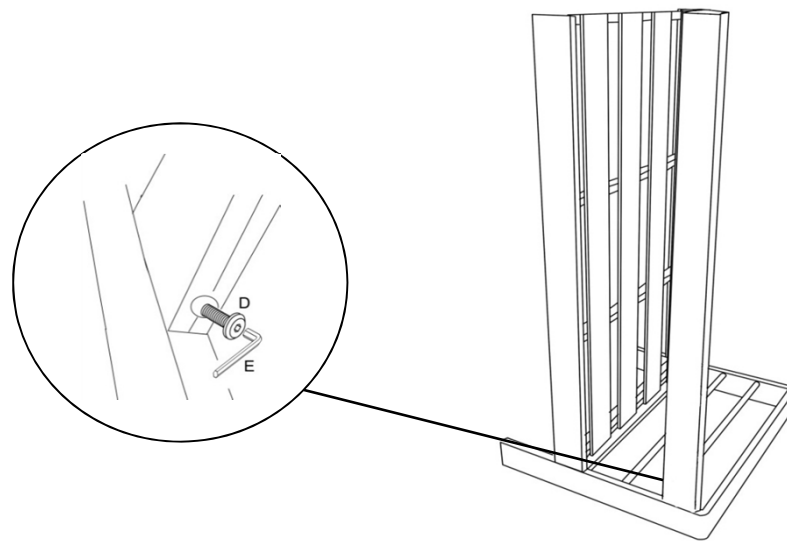

Attach Back Support Bar(B) to Side Panel(A) using Bolt(D) with Allen Key(E).
Loosely tighten the Bolt.

Step 5

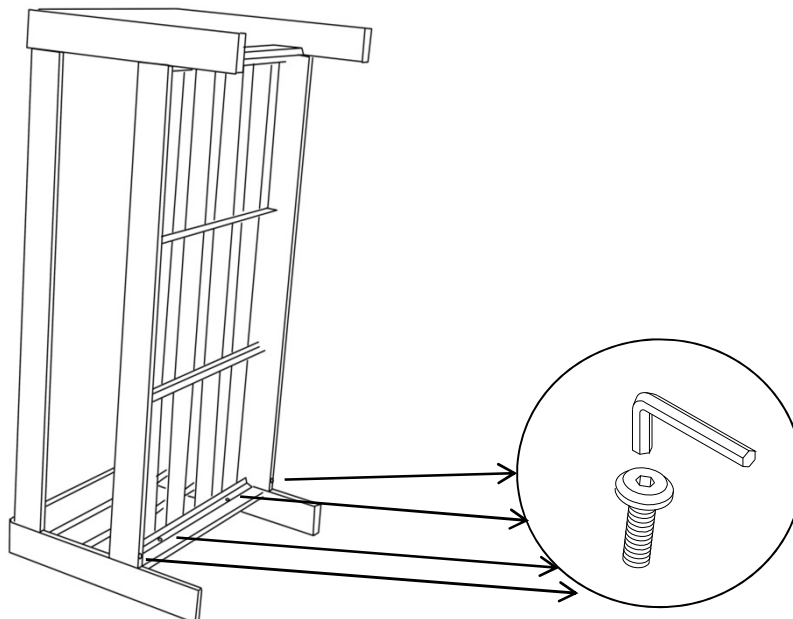

Repeat Step 1 to Step 3 to attach the second Side Panel(A).
Loosely tighten the Bolts.

Step 6

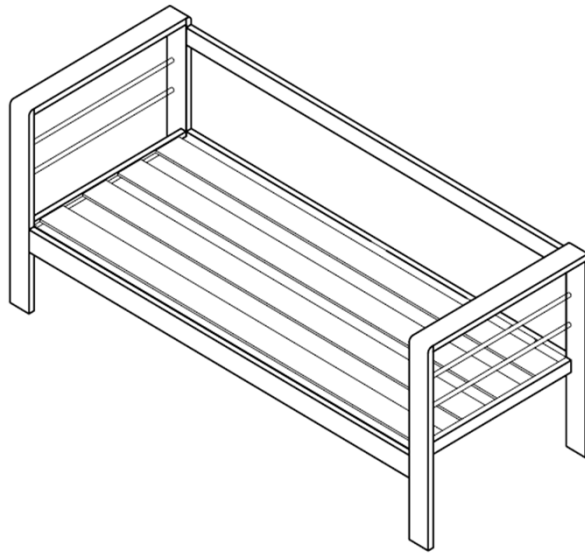

Stand up the loveseat frame , check stability and then tighten the bolts.





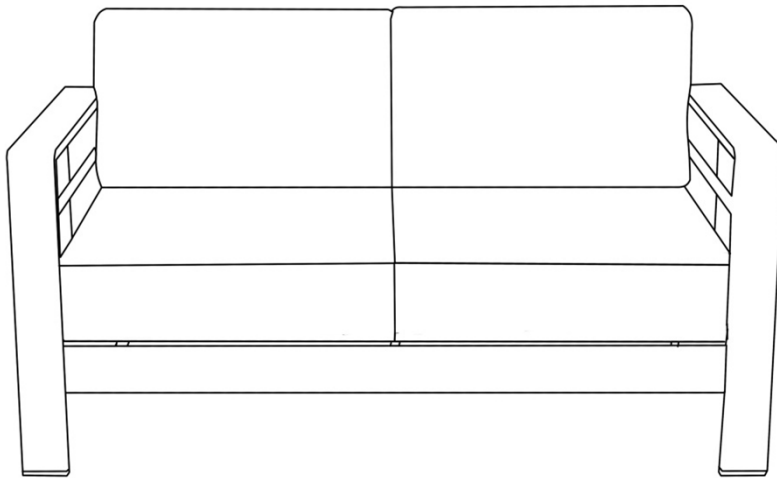













Note DO NOT fully tighten a BOLT in one go and then move on to the next. Rather, In a sequential manner, gradually tighten each Bolt until all bolts are evenly secured. This methodology will ensure maximum evenness once all Bolts are fully tightened.

Step 7



Put the Seat Cushions(F) and Back Cushions(G) on the Loveseat.
Your Loveseat is ready for use.

Care & Maintenance

-   • Do not put hot items directly on furniture surface
 -   • Do not clean furniture with harsh cleansers or polish.
 -   • To obtain the longest lifespan of your outdoor products, minimizing exposure to direct sunlight is recommended.
 -   • Children should not climb or jump on the furniture.
 -   • Do not write on furniture without a padded barrier to protect the surface.
 -   • To obtain the longest lifespan of your outdoor products, avoid extended and lengthy exposure to rain, snow, and direct sunshine. Whenever possible cover the product and /or place under patio or awnings.
 -   • Not for commercial use. For residential use only .
 -   • Stains may be removed with mild soap solution and damp cloth.
-
-   • Dust and pick-up spills using a clean, non-colored, lint-free cloth .

What is Proposition 65?

Proposition 65 is a California law that requires warning labels on products that may contain one of more than 800-plus chemicals or ingredients that the California Office of Environmental Health Hazard Assessment (OEHHA) has deemed to cause cancer or other reproductive toxicity. Chemicals and elements on this list include wood dust, brass, and other everyday substances, which can be found in very common household items, such as: lamps, tableware, jewelry, crystal glasses, electric cords, beauty products, automobiles, and furniture.

Why Did I Find a Proposition 65 Warning on My Home Goods Product?

We include Proposition 65 warnings on all of our products because there is always a chance that one of the 800-plus common chemicals and ingredients listed under this law could potentially be on our furniture or packing materials. We risk large fines under this law, if we don't include this warning.

Should I worry?

We realize you may be worried finding this warning on our products, but we want to reassure you that the hazardous exposure limits for any of these chemicals have never been found on furniture products that we've shipped to our customers. Additionally, this warning label is very common and can be found on almost every piece of furniture sold in the state of California.

Just How Common Are Proposition 65 Warnings?

Proposition 65 warnings have become so common in California that it is hard to take a trip to a local bank, grocery store, or restaurant without finding at least one warning. In fact, even the Disney Land Resort has a Proposition 65 warning:

