

OVERFLOW & DRAIN INSTALLATION

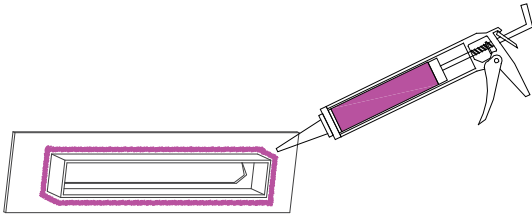

1. Locate hardware package. Remove overflow. Ensure the area on bathtub is clean, dry, and free from any debris. Apply a bead of silicone sealant around the back of the insert, (being careful to not apply too much).

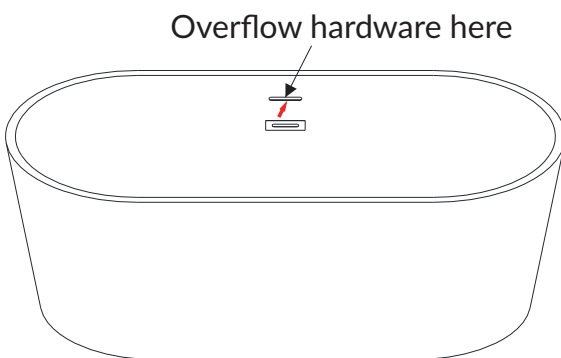

2. Press overflow insert into opening firmly. Be sure to wipe away any excess sealant that may come out.

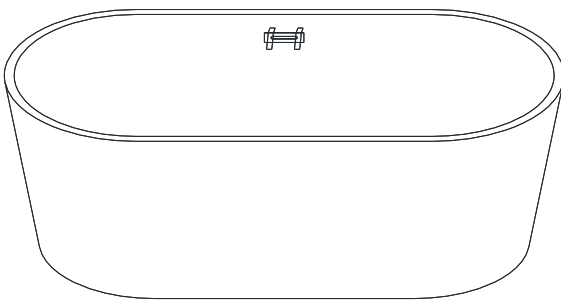

3. Hold in place and confirm that the overflow is inserted flat and that it appears level from all viewable angles. Then apply blue painters tape to keep in place until cured. After 24 hours the tape can be removed.

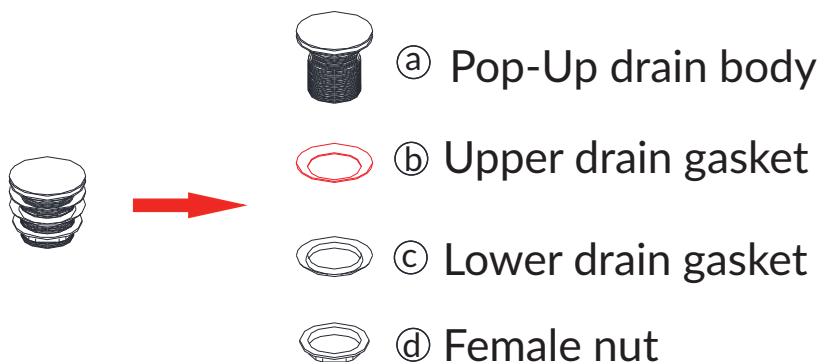

4. Remove drain assembly and disassemble parts (a)-(d) then proceed to step 5

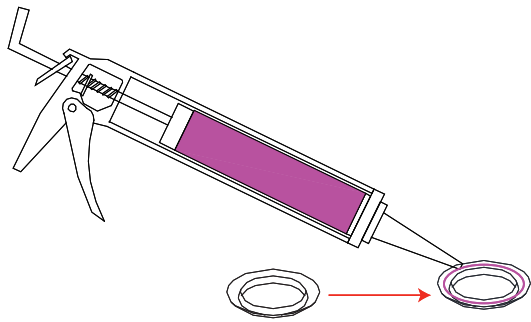

5. Apply sealant to lower drain gasket

© Lower drain gasket

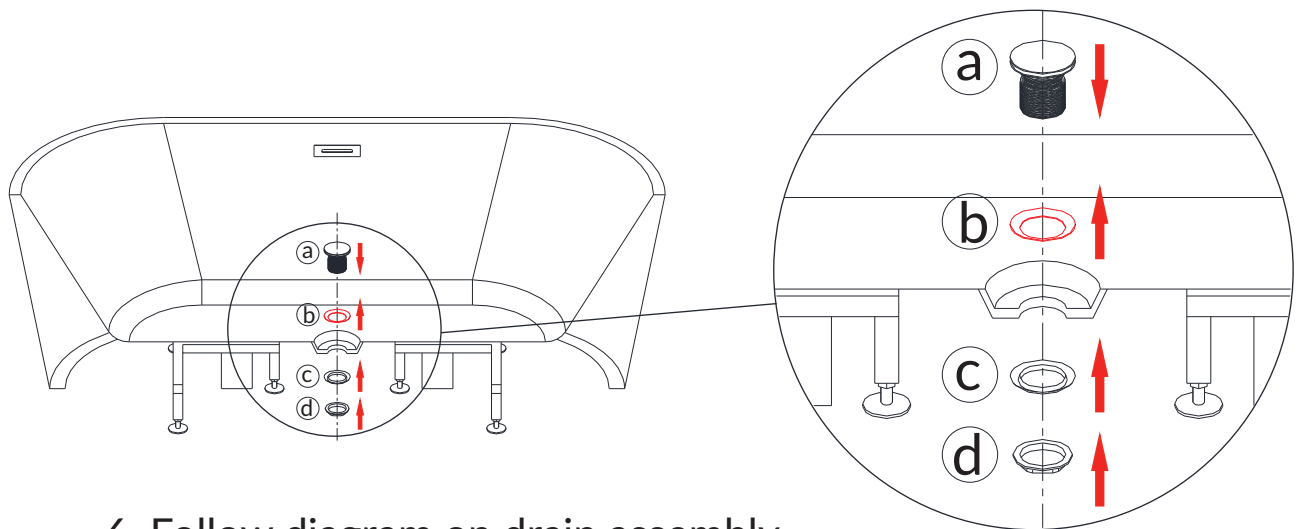

6. Follow diagram on drain assembly

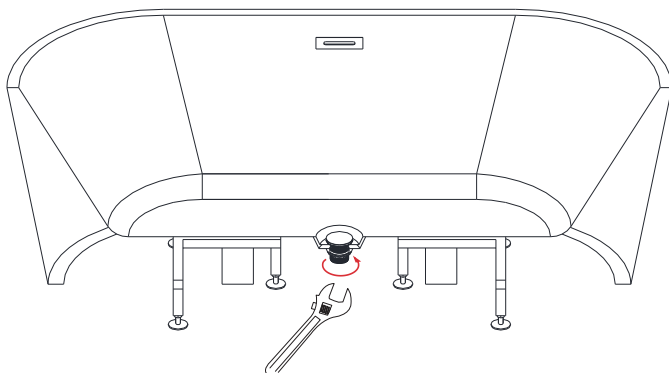

7. Tighten up

Please don't hesitate to contact us if you have any questions or concerns.

Customer Service Phone: 562-229-0088. (Monday - Friday 9 AM - 5 PM Pacific Time)

Or Email: help@woodbridgebath.com