



























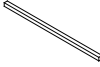



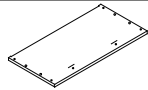

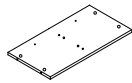



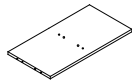

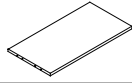
USER'S MANUAL

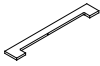
Floor Cabinet

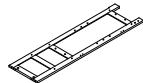
HARDWARE LIST

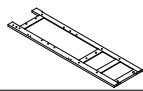
| | | | | | | | |
|------|--|------|---|-----|---|-----|---|
| Ax28 |  6*35mm | Fx8 |  4*30mm | Kx2 |  4*16mm | Px4 |  |
| Bx28 |  15*10mm | Gx3 |  4*35mm | Lx2 |  | Qx1 |  |
| Cx20 |  6*30mm | Hx1 |  | Mx4 |  | Rx1 |  4*40mm |
| Dx22 |  3*12mm | Ix2 |  | Nx4 |  | Sx1 |  |
| Ex3 |  3*14mm | Jx25 |  2.5*12mm | Ox4 |  | Tx2 |  |

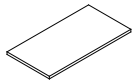
PART LIST





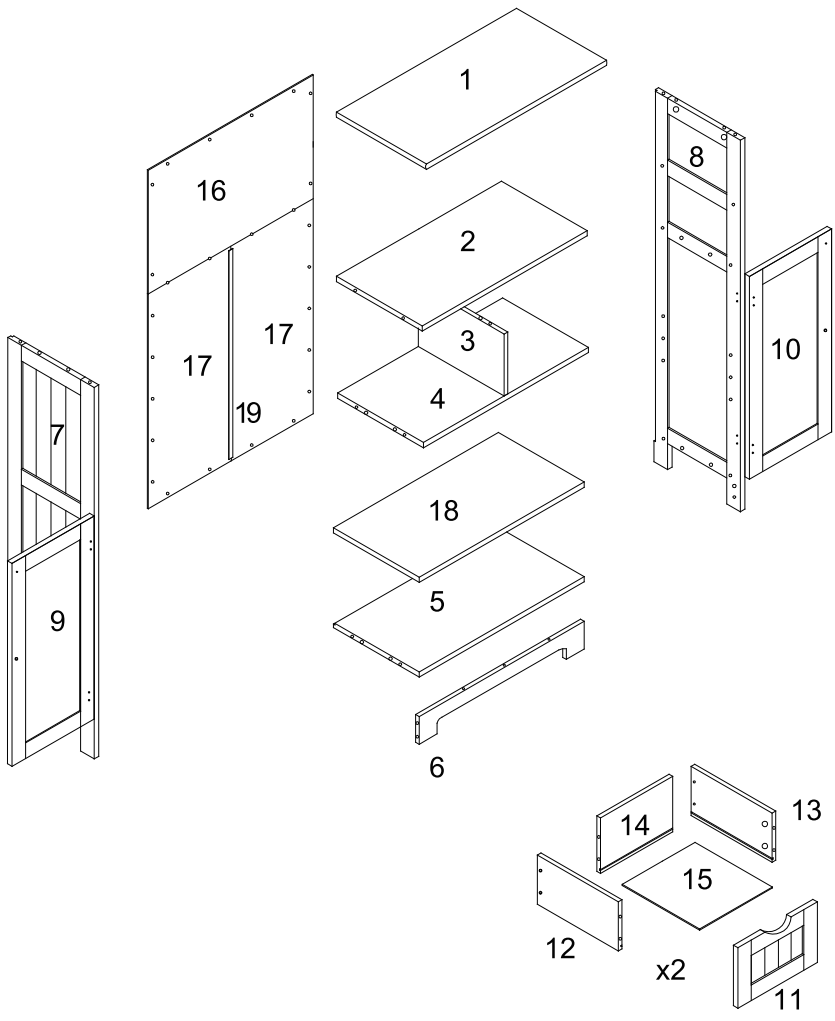

| | | | | | |
|---|---|----|----|---|----|
| 1 |  | x1 | 10 |  | x1 |
| 2 |  | x1 | 11 |  | x2 |
| 3 |  | x1 | 12 |  | x2 |
| 4 |  | x1 | 13 |  | x2 |
| 5 |  | x1 | 14 |  | x2 |
| 6 |  | x1 | 15 |  | x2 |
| 7 |  | x1 | 16 |  | x1 |
| 8 |  | x1 | 17 |  | x1 |
| 9 |  | x1 | 18 |  | x1 |
| | | | 19 |  | x1 |

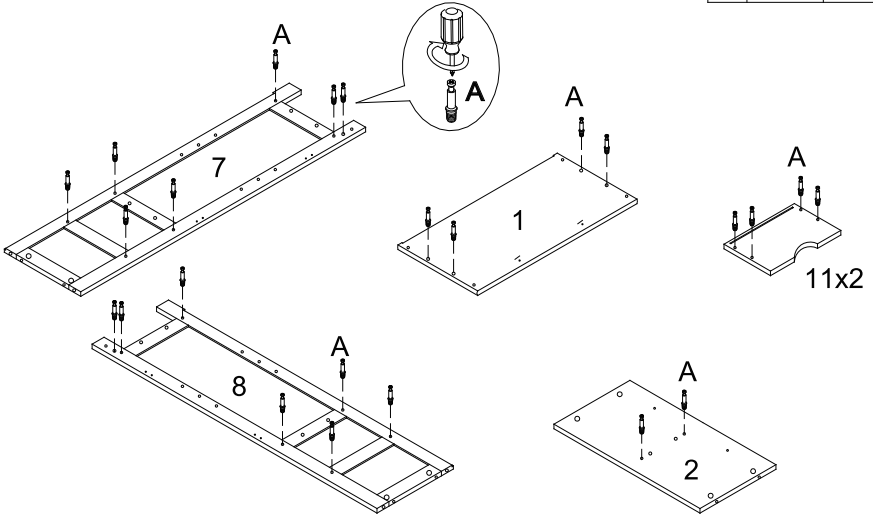
Part List Assembly Overview



| | | |
|---|---|-----|
| A |  | x28 |
|---|---|-----|



| | | |
|---|---|-----|
| D |  | x14 |
| E |  | x2 |
| H |  | x1 |
| I |  | x2 |
| M |  | x4 |
| P |  | x4 |

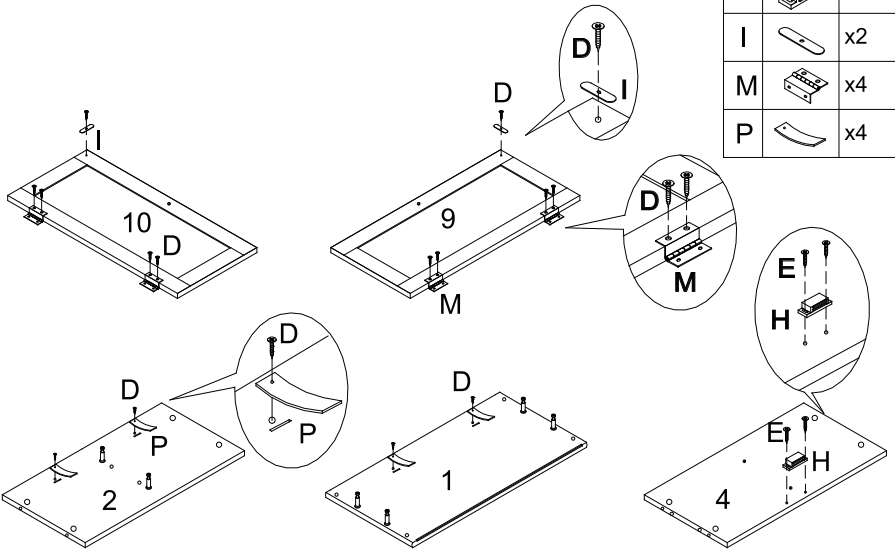

| | | |
|---|---|----|
| F |  | x8 |
|---|---|----|

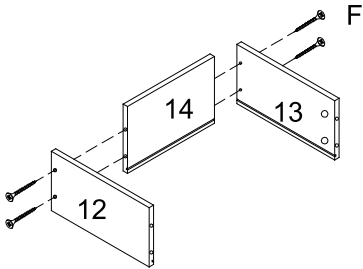

x2

| | | |
|---|---|----|
| B |  | x8 |
|---|---|----|

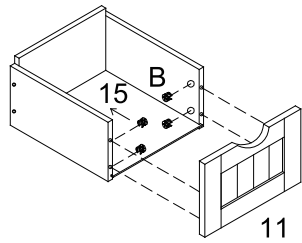
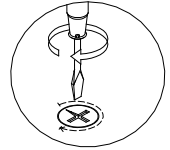

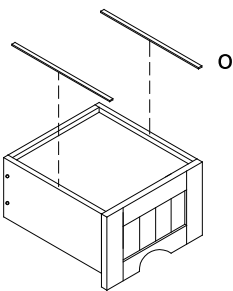

x2

| | | |
|---|---|----|
| O |  | x4 |
|---|---|----|





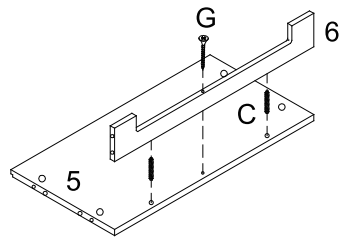

x2

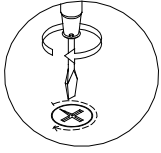
| | | |
|---|---|----|
| C |  | x2 |
| G |  | x1 |





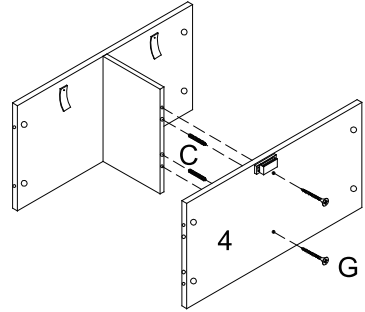
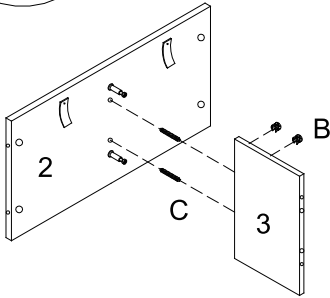

| | | |
|---|---|----|
| B |  | x2 |
| C |  | x2 |

| | | |
|---|---|----|
| C |  | x2 |
| G |  | x2 |





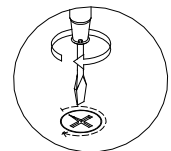
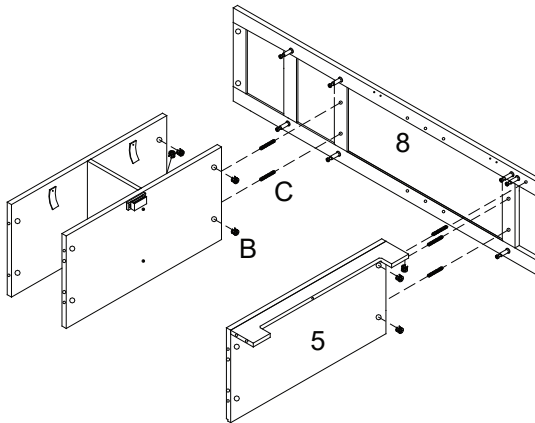

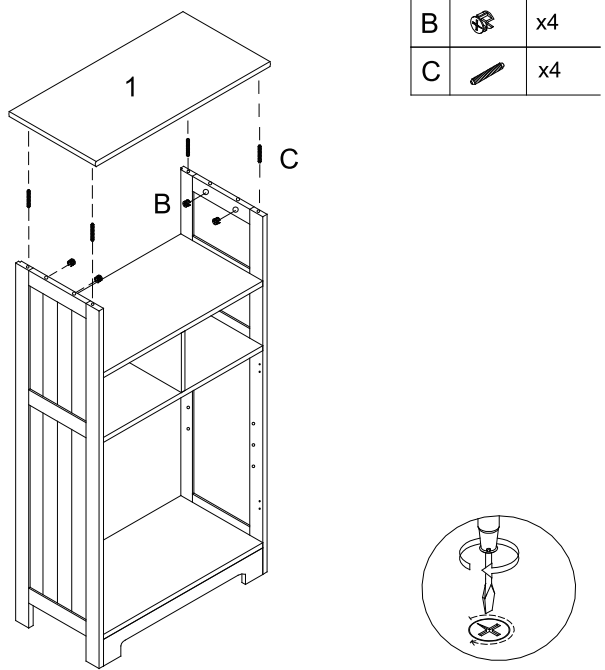
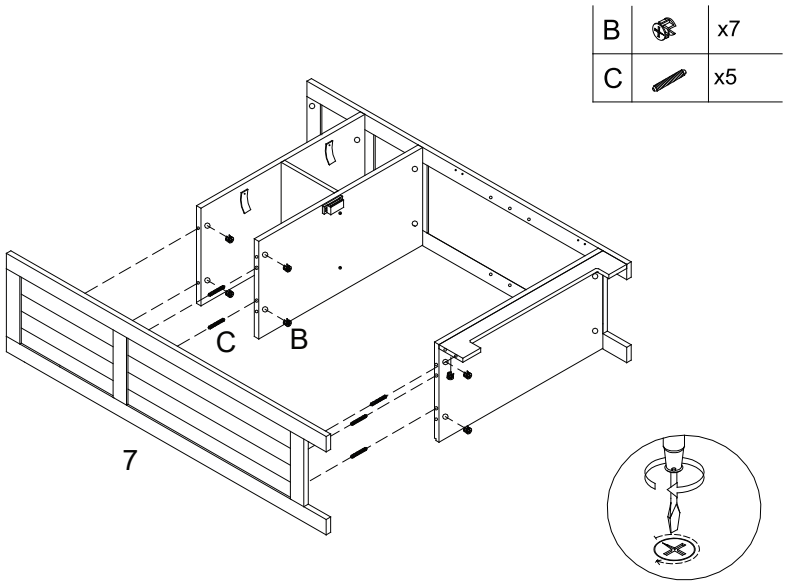
| | | |
|---|---|----|
| B |  | x7 |
| C |  | x5 |

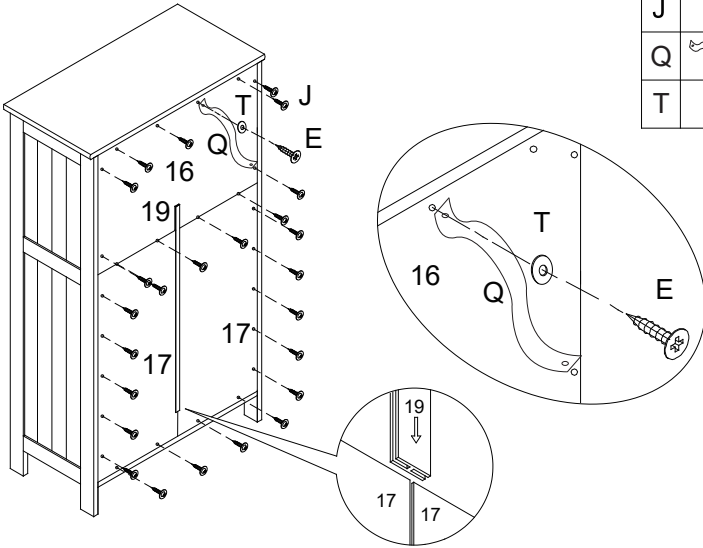







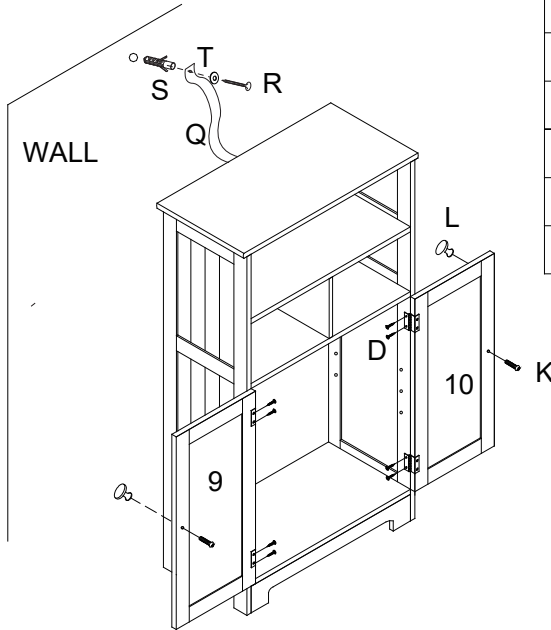



| | | |
|---|---|-----|
| E |  | x1 |
| J |  | x25 |
| Q |  | x1 |
| T |  | x1 |



| | | |
|---|---|----|
| D |  | x8 |
| K |  | x2 |
| L |  | x2 |
| R |  | x1 |
| S |  | x1 |
| T |  | x1 |

| | | |
|---|---|----|
| N |  | x4 |
|---|---|----|

