

# Instruction for installation and use of shower head

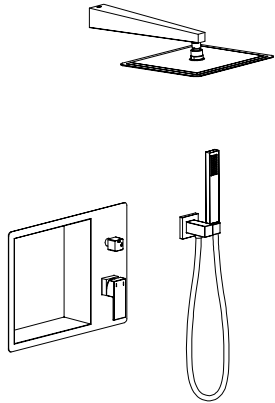

The product is subject to material object  
Thank you for purchasing this product. Please read this instruction carefully before using it.

## Packing list

When you open the product package, please count the accessories with the packing list. If there is a shortage, please contact the dealer soon.  
The following figure and table are for reference only. (Note: The product appearance may be different)

No.	Name	Quantity
1	Handle	1
2	Knob Hngdle	1
3	Niche	1
4	Thermostatic Mixing Valve	1
5	Hand Shower Holder	1
6	Flexible Shower Hose	1
7	Hand Shower	1
8	Top Spray	1
9	Shower Pole	1
10	S8 Hexagonal Wrench	1
11	S2.5 Hexagonal Wrench	1
12	Expansion Pipe	4
13	Screw	4
14	φ7 Decorative Cover	2

## Installation environment

- The size of the purchased faucet matches the size of the faucet mounting hole.
- Inlet water pressure requirement:  $0.05\text{MPa} \leq \text{inlet pressure} \leq 0.5\text{MPa}$ . To ensure the good use of the faucet, please keep the water supply pressure of cold and hot water balanced.
- Water temperature requirements: the cold water temperature is  $39.2^{\circ}\text{F}-84.2^{\circ}\text{F}$ , the hot water temperature is  $131^{\circ}\text{F}-185^{\circ}\text{F}$ , and the recommended normal service temperature is  $131^{\circ}\text{F}-149^{\circ}\text{F}$  (faucet products are suitable for hot and cold water supply pipes in buildings, and the medium temperature is not more than  $185^{\circ}\text{F}$ ); Cannot be used in other fluid environments except water or for other purposes; Please note that the product or parts may be damaged if the environmental temperature of the product is too low (below  $39.2^{\circ}\text{F}$ ) or too high (above  $185^{\circ}\text{F}$ ).
- When installing the faucet, be sure to notice the hot and cold water inlet marks of the faucet (red indicates hot water and blue indicates cold water).
- If customers go out for a long time or don't use the faucet for a long time, please close the main valve of the faucet first and turn on the faucet switch to release the pressure and accumulated water in the faucet.

## Installation size

Before installation, refer to the product installation dimension drawing to determine the installation position, and embed cold and hot water pipes in the wall (the thread and center distance must conform to the product size); Wash the pipeline and the position where the faucet is installed with a washing tool to remove sediment, copper scraps, etc.

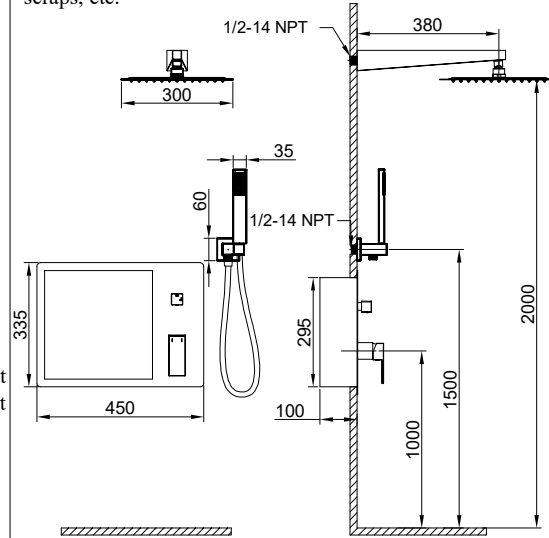

## Installation items and methods

- The faucet body has been tested and debugged before leaving the factory. Please do not disassemble it by yourself!
- Before installing the faucet, please be sure to confirm whether the water inlet pipeline and angle valve are correctly installed; The impurities and sludge in the embedded water pipe have been removed to avoid blocking the faucet and affecting the water outlet function.
- After installation, please check whether the joints are tightly connected and whether the pipeline leaks.
- When installing and using the faucet, please use normal torque to prevent the handle and bent foot from breaking.
- When using, please turn on cold water first, and then turn on hot water to adjust the temperature, so as not to burn.
- Users must cover and protect the electroplating products such as faucets when installing them. If there is cement, lime slurry and sand dripping on the surface, it must be cleaned within 30 minutes.

① Digging holes in the blank wall at the right place

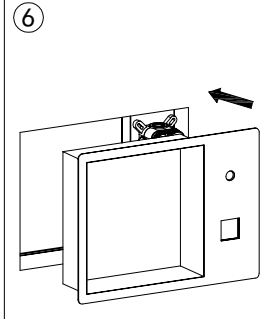
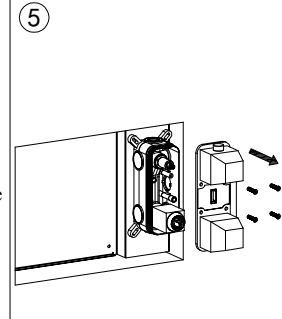
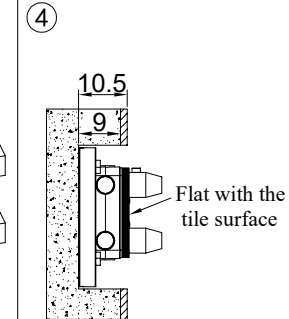
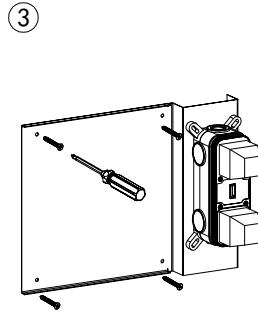
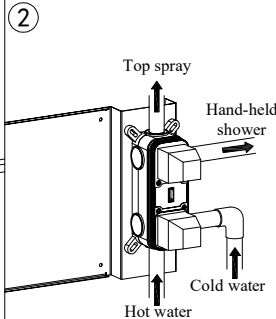
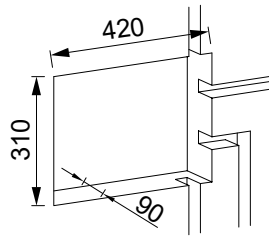

⑦ Glass glue on all sides

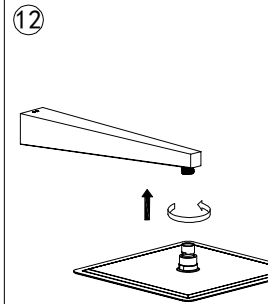
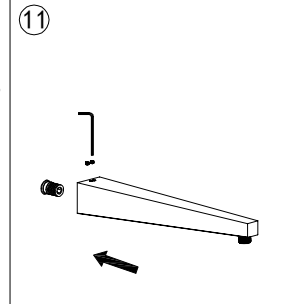
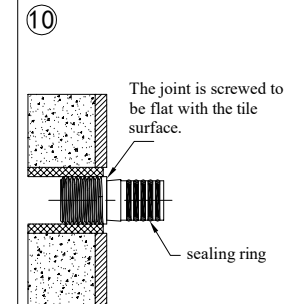
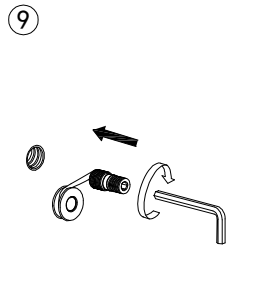
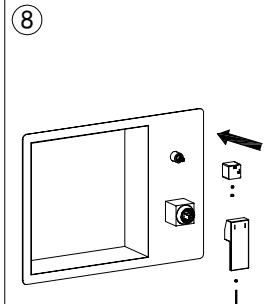
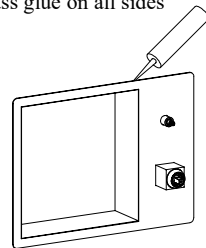

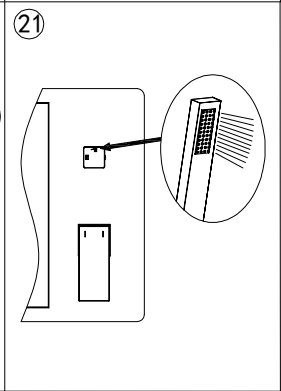
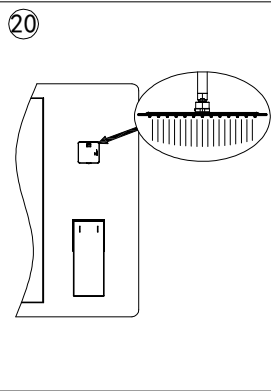
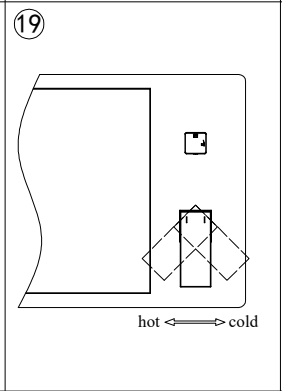
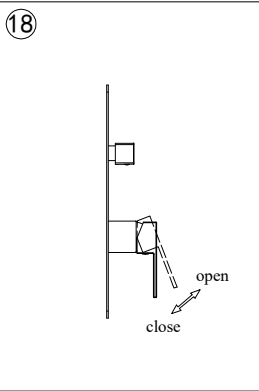
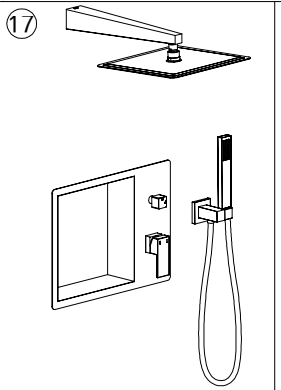
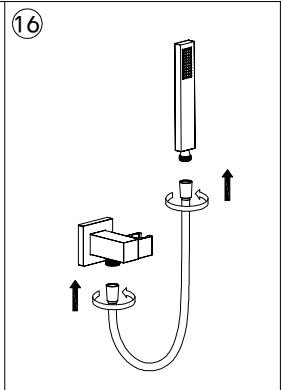
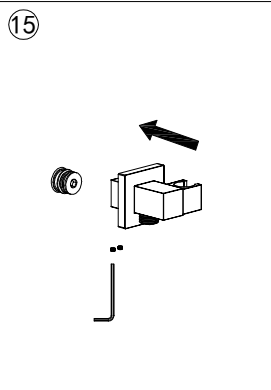
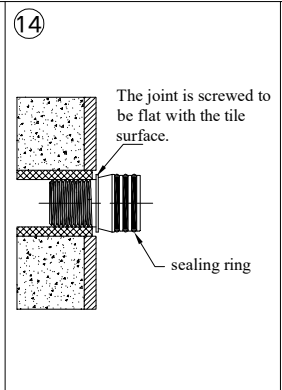
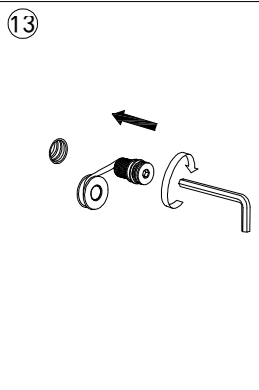

### Repair and maintenance

1. To keep the faucet bright and clean, please clean the faucet frequently or regularly.
2. Rinse with water only, and dry the faucet with soft cotton cloth.
3. Do not use detergent containing coarse particles such as cleaning powder or polishing powder, nylon brush, emery cloth or sandpaper, avoiding wearing the product.
4. Do not use any acidic cleaning agent or rough cleaning agent or soap to polish.
5. When the water flow of the faucet is obviously reduced, please clean the filter screen of the shower head and the rubber particle hole of the shower head, so as not to affect the water flow of the shower head or block it and burst it. Example: The water flow at the shower head is obviously reduced or some rubber particles do not come out. Please rub the rubber particles at the shower head by hand or use sewing needle to make holes in the rubber particles at the shower head.
6. If a lot of cleaning work is needed, please follow the following procedures:
  - A. Use clean water and soft cloth to remove dirt and scale film on the surface as far as possible;
  - B. Use any of the following cleaning agents to remove surface dirt and scale film;
    - Mild liquid cleaner;
    - Colorless glass cleaner, powder cleaner that has no grinding effect and can be completely dissolved (and mixed according to the manufacturing instructions);
    - Polishing liquid without abrasion;
    - Stubborn dirt can be soaked in hot vinegar, then wiped with wax or scrubbed with toothpaste or with special hardware cleaner;
  - C. After cleaning, please remove all cleaning agents with clean water and wipe them dry with soft cotton cloth.