

# ASSEMBLY INSTRUCTIONS

## TOOLS REQUIRED:

Allen Wrench (Provided, Part D)

## BEFORE YOU START:

1. Check the hardware against the hardware list to make sure all items are present.
2. Assemble your furniture on a soft, flat surface to avoid scratching the finish.
3. **CAUTION:** Do not over tighten screws, nuts or bolts during assembly.
4. Your furniture may require occasional tightening.

## INSTRUCTIONS:

1. Turn the table top on to a clean soft surface.
2. Attach legs to the top frame using Bolt (A), Lock Washer (B), Flat Washer (C) and Allen Wrench (D).  
As Shown in Figure 1.(Do not tighten bolts).
3. Attach bottom frame to the legs using Bolt (A), Lock Washer (B) and Flat Washer (C) and tighten with the Allen Wrench (D).  
As Shown in Figure 2.
4. Tighten all bolts before setting table back upright and then insert the glass on top. As Shown in Figure 3.

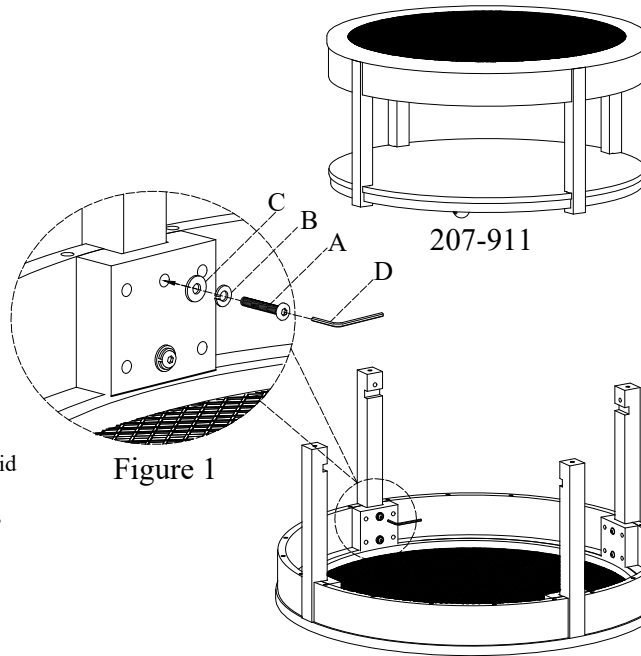

Figure 1

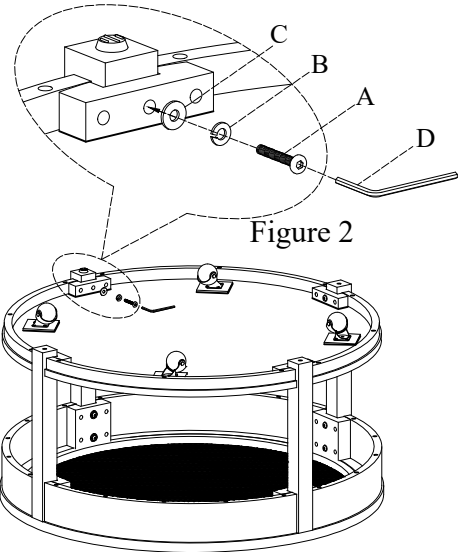

Figure 2

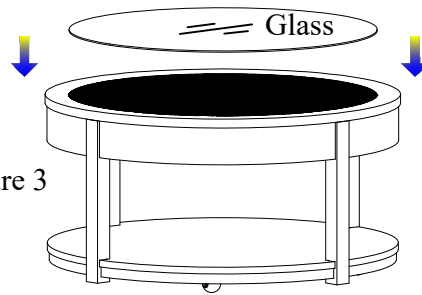





Figure 3

HARDWARE LIST			
A		Bolt (Ø1/4"*1-1/2")	12pcs
B		Lock Washer (Ø1/4")	12pcs
C		Flat Washer (Ø1/4"*Ø3/4")	12pcs
D		Allen Wrench (4mm)	1pc