

DIMENSIONS

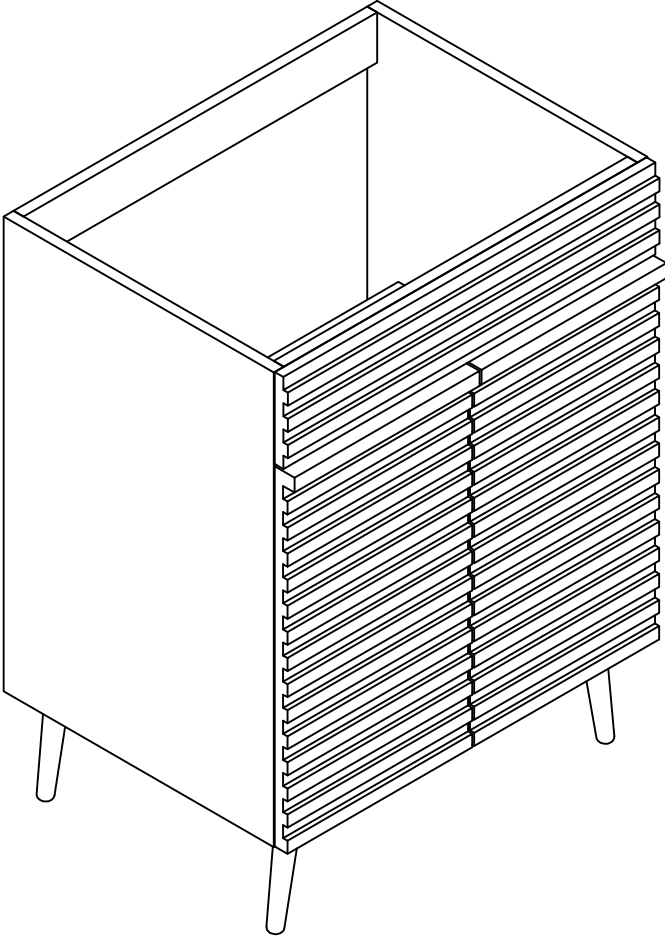

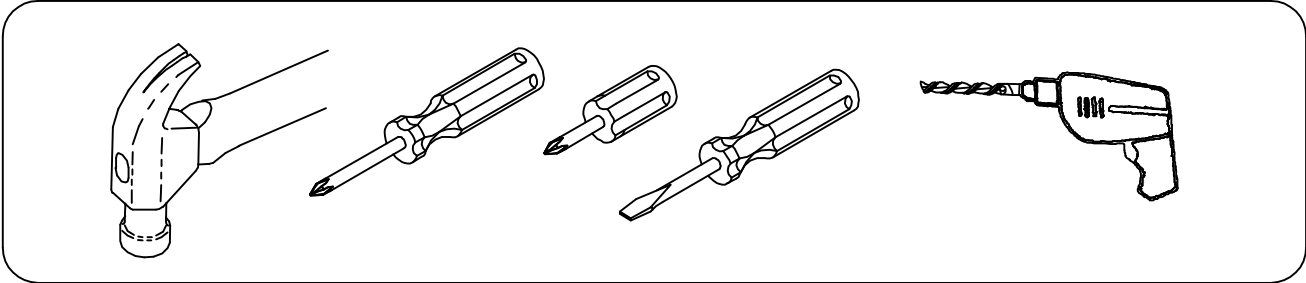





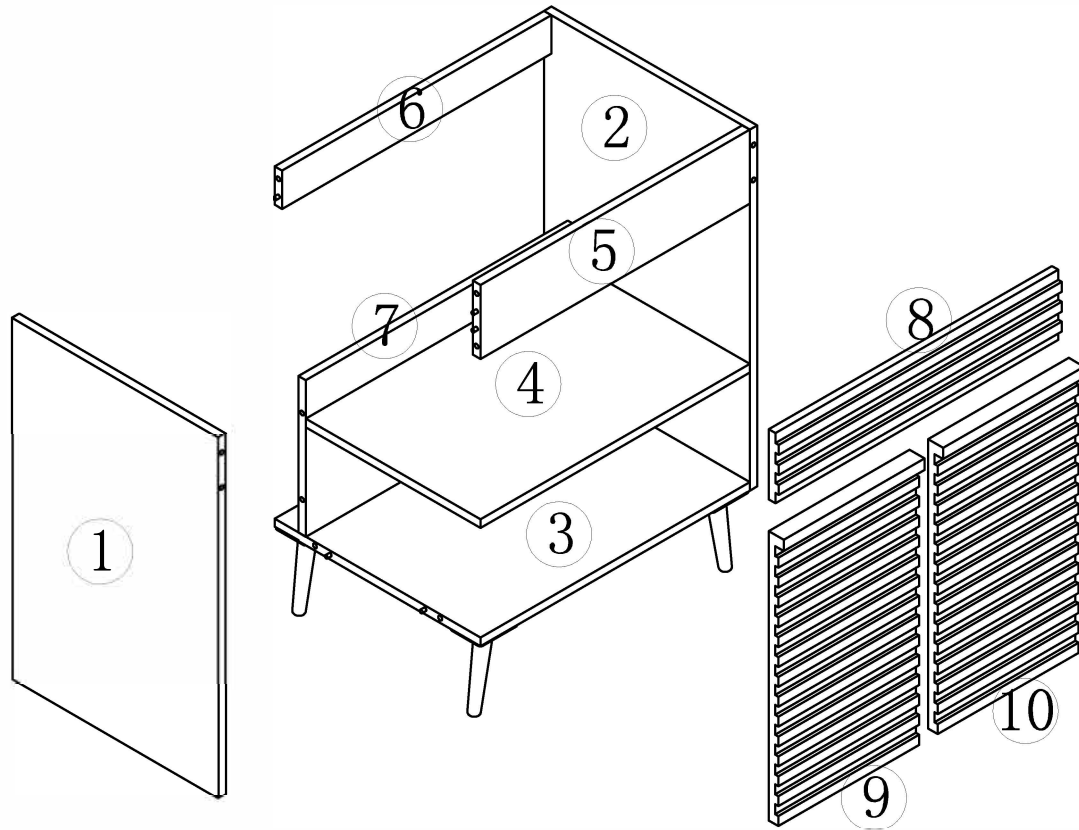







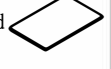



YOU MAY NEED (NOT SUPPLY)





ASSEMBLY DIAGRAM



PARTS LIST					
PARTS LIST					
NO	DESCRIPTION	QTY	NO	DESCRIPTION	QTY
①	Left side panel 	1	⑥	Rear baffle 	1
②	Right side panel 	1	⑦	Rear baffle 	1
③	Bottom panel 	1	⑧	Front sealing plate 	1
④	clapboard 	1	⑨	Left door panel 	1
⑤	Front pull strips 	1	⑩	Right door panel 	1

PARTS LIST					
HARDWARE LIST					
NO	DESCRIPTION	QTY	NO	DESCRIPTION	QTY
A	Three-in-one eccentric wheel 	18	F	Two-in-one screws 	4
B	Three-in-one connecting rod 	18	G	4*16mm screw 	40
C	Three-in-one sticker 	18	H	Metal feet 	4
D	8*40mm wood dowel pins 	10	I	Door hinges 	4
E	Two-in-one lock handle 	4			
CAUTION: Please confirm the parts list before installation					

STEP 1

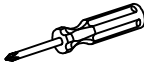
HARDWARE LIST		
Three-in-one connecting rod B  18PCS	Two-in-one screws F  4PCS	

1. Put the three-in-one connecting rod in the 10mm hole of the following panels and tighten them with a cross screwdriver or an electric tool.

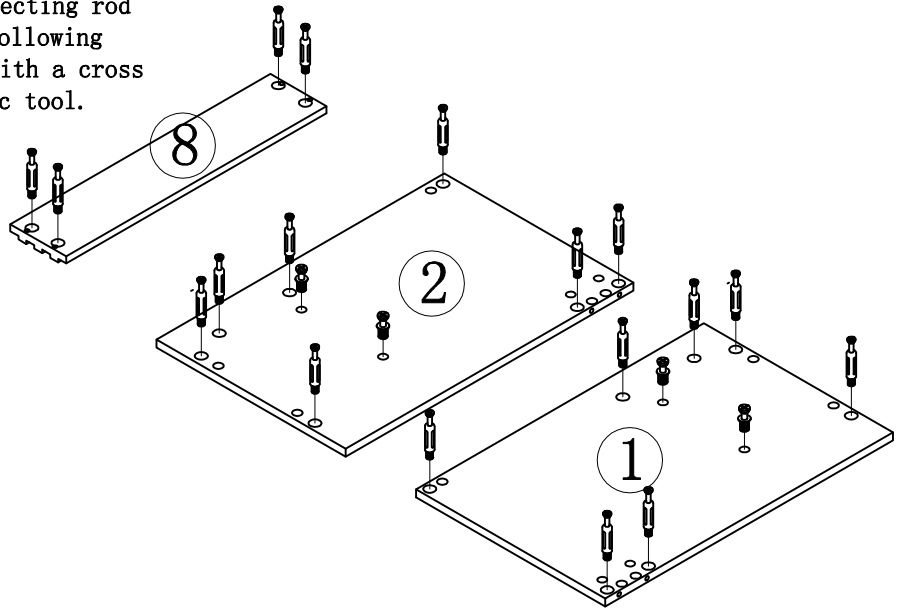
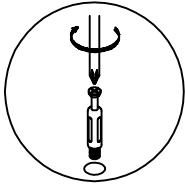

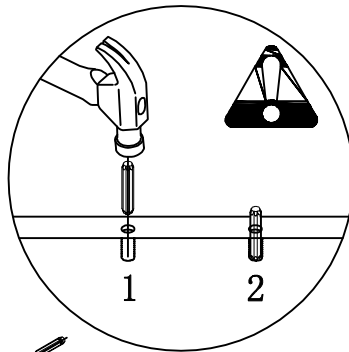

STEP 2

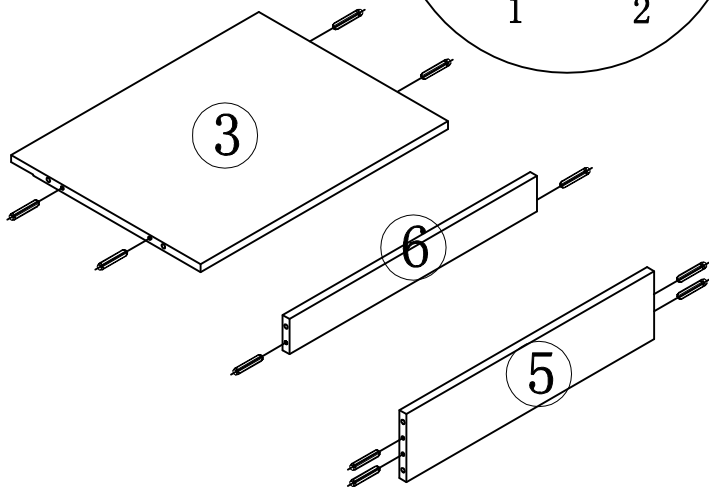

1. Strike the 08*40mm wood dowel pin into the 8mm hole of the above panels with an iron hammer. Please note that the hole of the three-in-one connecting rod should also be 8mm. The hole of the three-in-one connecting rod connects to the hole of 15mm three-in-one eccentric wheel.



HARDWARE LIST	
8*40mm wood dowel pins D  10PCS	

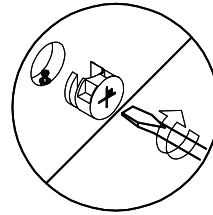
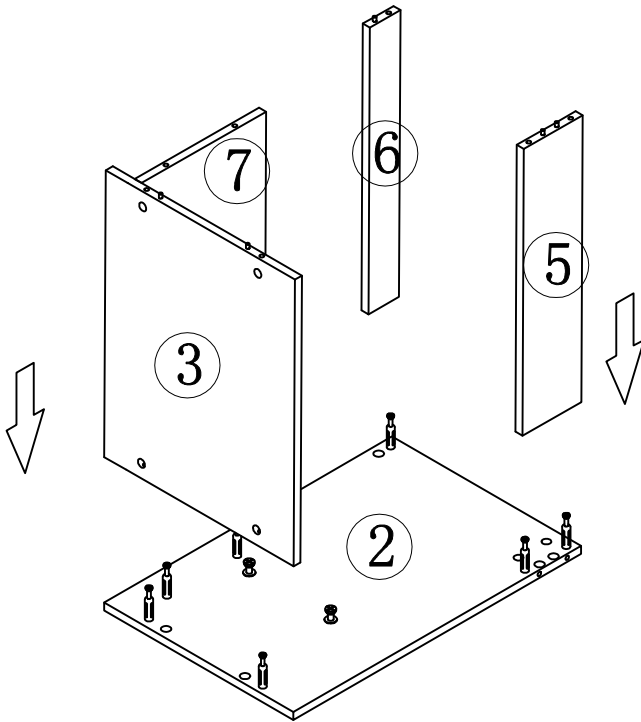

STEP 3

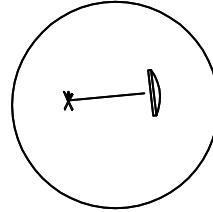

1. Connect No. 3-5-6-7 panel to No. 2 panel tightly with the three-in-one eccentric wheel.



2. Cover the mounting hole of the eccentric wheel with a three-in-one sticker.

HARDWARE LIST		
Three-in-one eccentric wheel A  7PCS	Three-in-one sticker C  7PCS	

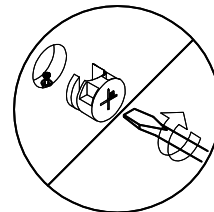
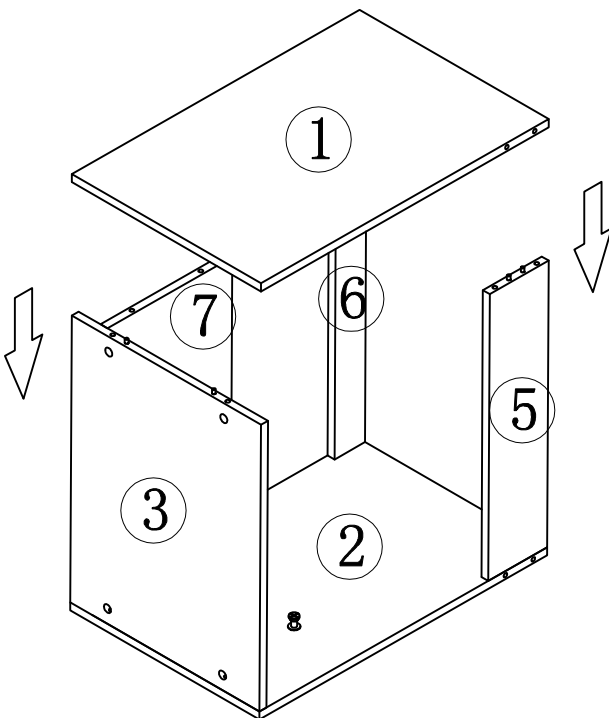

STEP 4

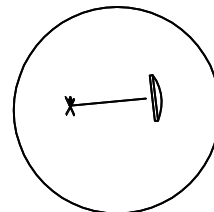

1. Connect No. 1 panel to No. 3-5-6-7 panel tightly with the three-in-one eccentric wheel.





2. Cover the mounting hole of the eccentric wheel with a three-in-one sticker.

HARDWARE LIST		
Three-in-one eccentric wheel A  7PCS	Three-in-one sticker C  7PCS	

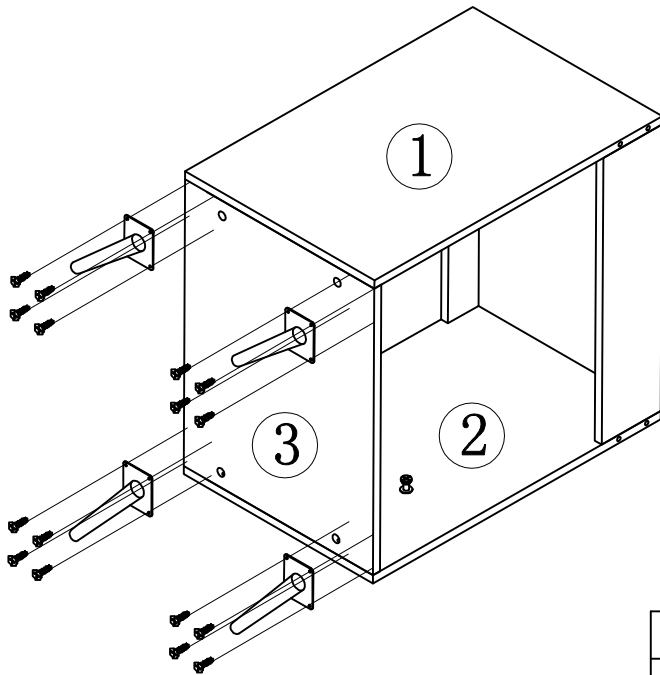
STEP 5





Use 4*16 screws to fix the Metal feet

HARDWARE LIST		
4*16mm screw	Metal feet	
G  16PCS	H  4PCS	

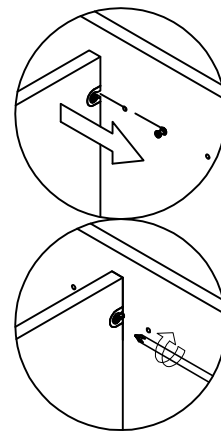
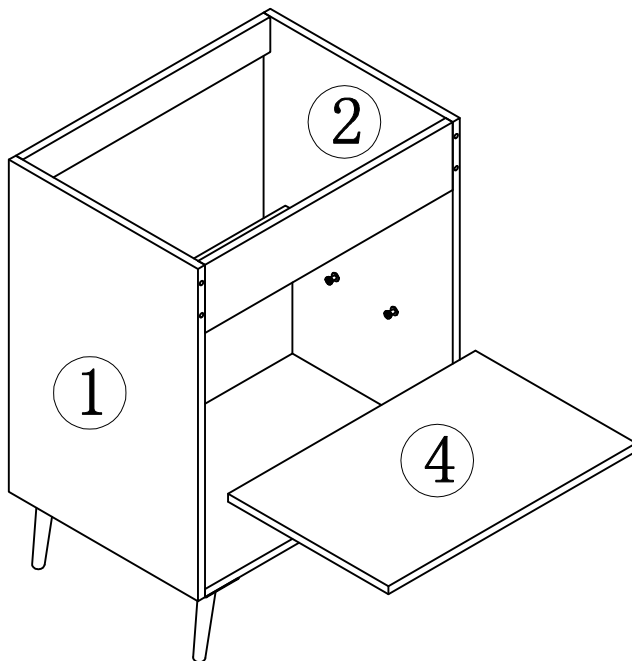
STEP 6



Fix the two-in-one lock handle on No.4 plate and put it in the cabinet. Put the pipe plug on No. 4 plate

HARDWARE LIST	
Two-in-one lock handle	
E  4PCS	

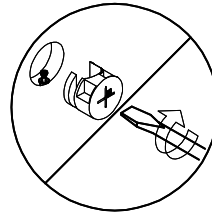
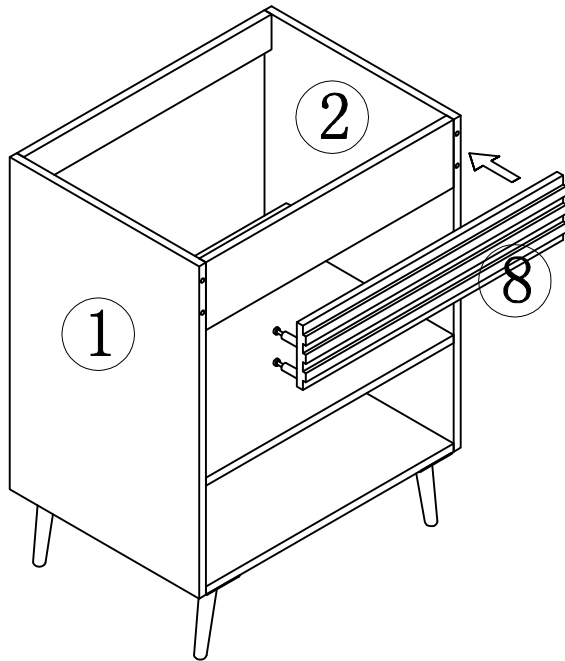

STEP 7

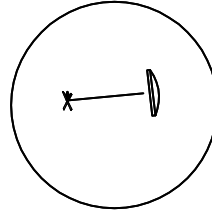

1. Connect No. 8 panel to No. 1-2 panel tightly with the three-in-one eccentric wheel.



2. Cover the mounting hole of the eccentric wheel with a three-in-one sticker.

HARDWARE LIST		
Three-in-one eccentric wheel A  4PCS	Three-in-one sticker C  4PCS	

STEP 8

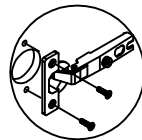
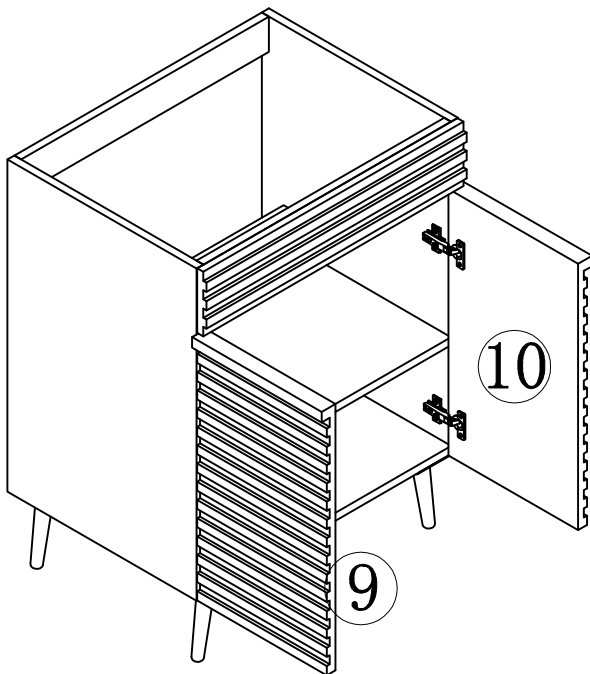

1. Install the hinge cup to the door panel with 4*16mm screws.

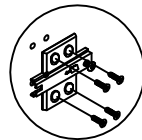

2. Install the hinge to the side panel with 4*16mm screws.

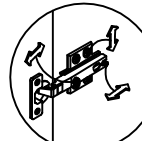

4. Adjust the door panel clearance.

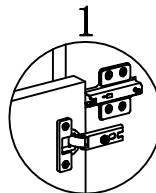

1

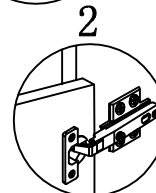

2

3. Install the hinge cup on the door panel to the hinge of the side panel.

HARDWARE LIST		
4*16mm screw G  24PCS	Door hinge I  4PCS	



Choking hazard-Small Parts : This unit contains small parts, not for children under 3 years.

Tip-over hazard : Secure finished unit to wall stud using L-Bracket and wall screw (#10*1.5"W/out provided). If a wall stud is not neccessible , Consault your local hardware store for appropriate mounting hardware . Failure to properly install will result in product collapse or tip-over. Serious injury can occur .