

Bar table

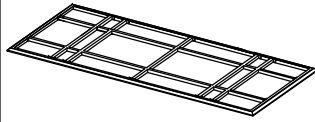

A: 1PC

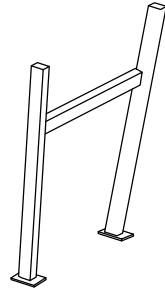

B: 2PCS

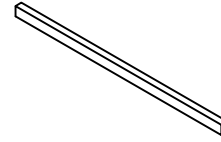

C: 1PC

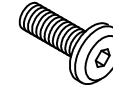

D: M6*20*10PCS

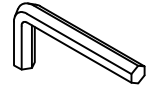

E: 4MM*1PC

Please assemble all components firstly,
then tightly fix all screws.

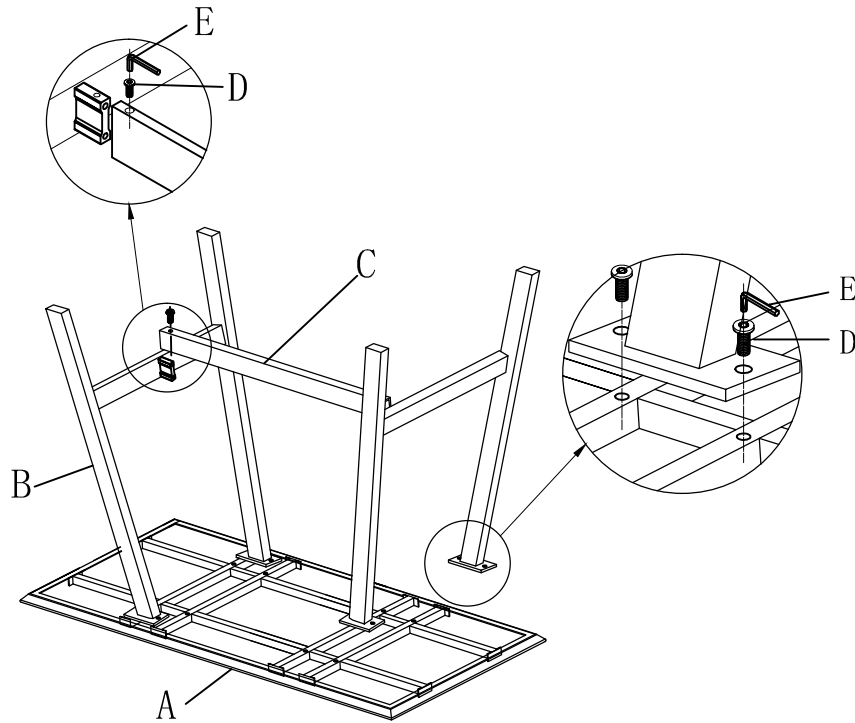

1

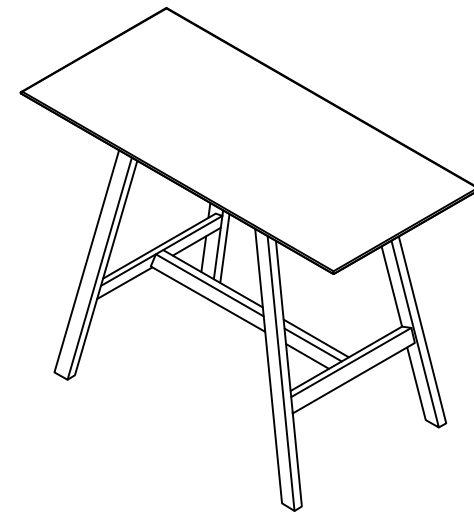

2