

INSTRUCTION MANUAL

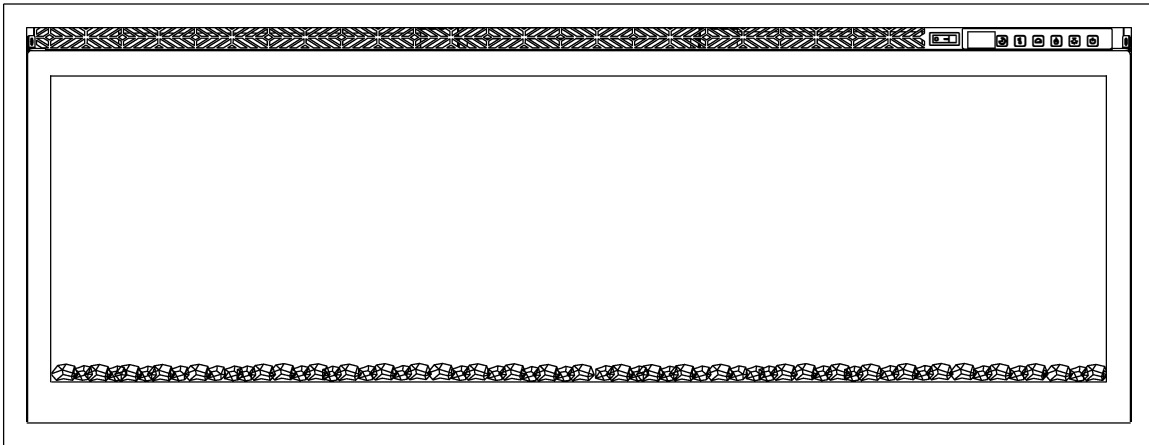

50",60",72" Recessed Electric Fireplace AC120V 60Hz 1400W



WARNING

Read and understand this entire owner's manual, including **all safety information**, before plugging in or using this product. Failure to do so could result in **fire, electric shock, or serious personal injury**.



CAUTION

Keep this owner's manual for future reference. If you sell or give this product away, **make sure this manual accompanies this product**.



IMPORTANT SAFETY INFORMATION WARNING!

- **THIS FIREPLACE IS HOT WHEN IN OPERATION AND CAN CAUSE SEVERE BURNS**

- Do not operate fireplace before reading and understanding operating instructions. Failure to operate fireplace according to operating instructions could cause fire or injury.
- Risk of burns. This fireplace is HOT when in operation and heating element is ON. Power to the fireplace should be turned off and the fireplace allowed to cool before servicing. To disconnect power to the fireplace, turn controls to off, then remove plug from outlet.
- Do not install damaged, incomplete, or substitute components.
- Young children should be carefully supervised when they are in same room with fireplace. Toddlers, young children and others may be susceptible to accidental contact burns. A physical barrier is recommended if there are at risk individuals in the house. To restrict access to the fireplace, install an adjustable safety gate to keep toddlers, young children and other at risk individuals away from the fireplace and hot surfaces.
- Clothing and other flammable material should not be placed on or near the fireplace.
- Due to high temperatures, the fireplace should be located out of traffic and away from furniture and draperies.
- Ensure that you have incorporated adequate safety measures to protect infants/toddlers from touching hot surfaces.
- It is imperative that the control compartments, circulating blower, and its passageway is kept clean.
- Under no circumstances should this fireplace be modified.
- Do not use the fireplace if any part has been under water.
- Do not operate the fireplace with the glass panel removed, cracked or broken.
- Keep the packaging material out of the reach of children. As with all plastic bags, these are not toys and should be kept away from children and infants.
- Servicing should only be done while the fireplace is disconnected from the power outlet.
- Unplug fireplace if not being used for an extended period of time.
- Do not operate this fireplace with a damaged cord or plug after the fireplace malfunctions, has been dropped, or damaged in any manner.
- Always plug this fireplace into a wall outlet or receptacle. Never plug this fireplace into a surge protector, extension cord, or relocatable power tap.
- Do not use outdoors.
- Never locate fireplace where it may fall into a bathtub or other water container.
- Do not run the cord under carpeting. Do not cover cord with throw rugs, runners, or the like. Arrange cord away from traffic area and where it will not be tripped over.
- Connect to properly grounded outlets only.
- Do not insert foreign objects into any ventilation or exhaust opening as this may cause an electric shock, fire, or damage to the fireplace.
- To prevent a possible fire, do not block the air intakes or exhaust in any manner. Do not use on soft surfaces, like a carpet, where openings may be blocked.
- Ensure clearances to combustibles are maintained when building a mantel or shelves above the fireplace.
- Elevated temperatures on the wall or in the air above the fireplace can cause melting, discoloration or damage to the decorations, a TV or other electronic components.

General Information

CSA Approval Listing Information

This fireplace has been tested in accordance with the CSA Standards for fixed and location-dedicated electric room appliances in the United States and Canada. If you need assistance during installation, please contact our Email.

Note: This fireplace must be electrically wired and grounded in accordance with local codes or, in the absence of local codes, with National Electric Code ANSI/NFPA 70-latest edition in the United States or the Canadian Electric Code, CSA C22.1 in Canada.

Fireplace Specifications

Model Number	50W	58W	60W
Description	50"	60"	72"
Voltage	120V AC	120V AC	120V AC
Watts	1400W	1400W	1400W
Amps	12A	12A	12A
Fireplace Widthr	50"	60"	72"
Fireplace Height	19 1/4"	19 1/4"	19 1/4"
Fireplace Depth	5 1/2"	5 1/2"	5 1/2"
Shipping Weight	30kg	35kg	41.3kg
Fireplace Weight	25.5kg	29kg	35.5kg

Dimensional Drawings

50" Dimensions

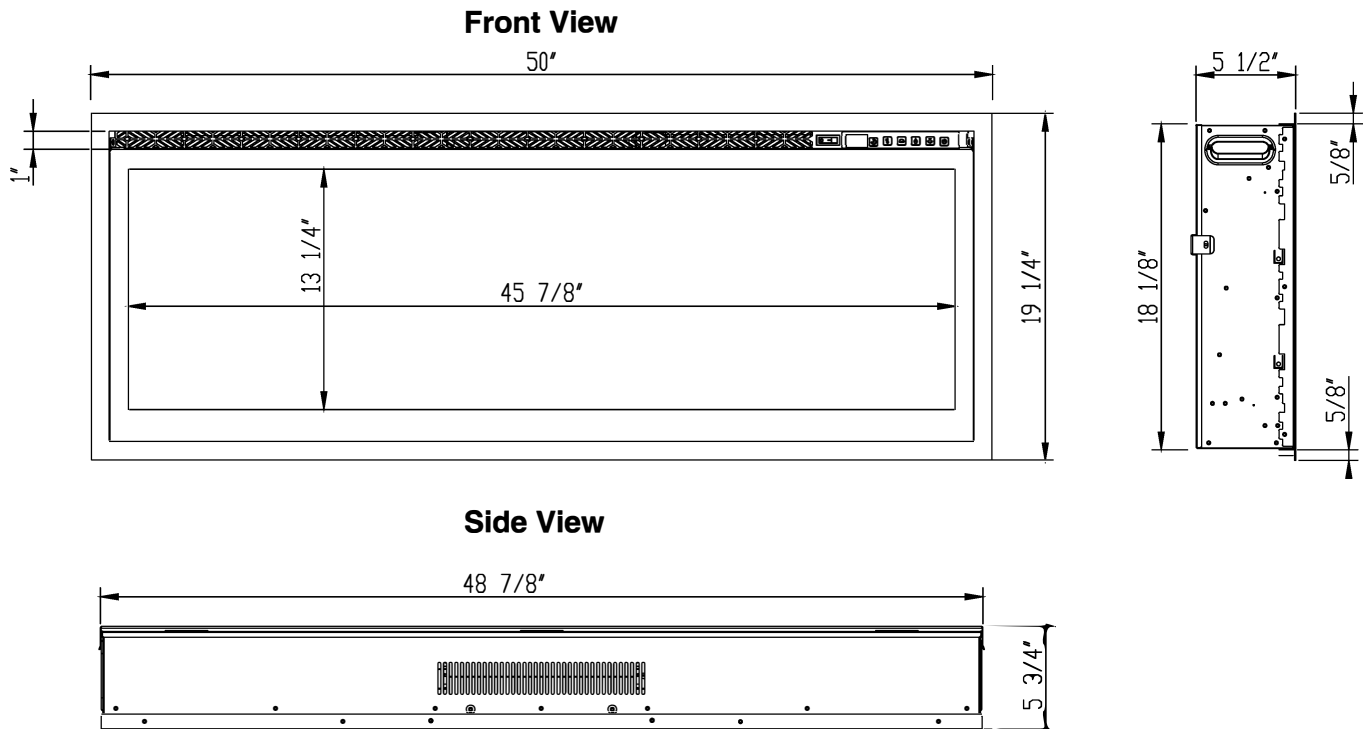

Features

- programmable thermostat
- 3 speed flame options
- 13 color media bed and 13 color flame options
- Designed for recessed mounting in wall
- Remote control for heat and flame setting(batteries not included)
- Dual mode ,operates with or without heat for only flame effect
- Built in timer 1 to 8 hours
- Faux drift wood fire logs and glass crystal media options

Sepecifications

- Frame color :black
- Watts:1400W
- BTU'S:4800
- Room Coverage:400 ft.
- Voltage::AC120V
- Amperes:12A

Dimensional Drawings

60" Dimensions

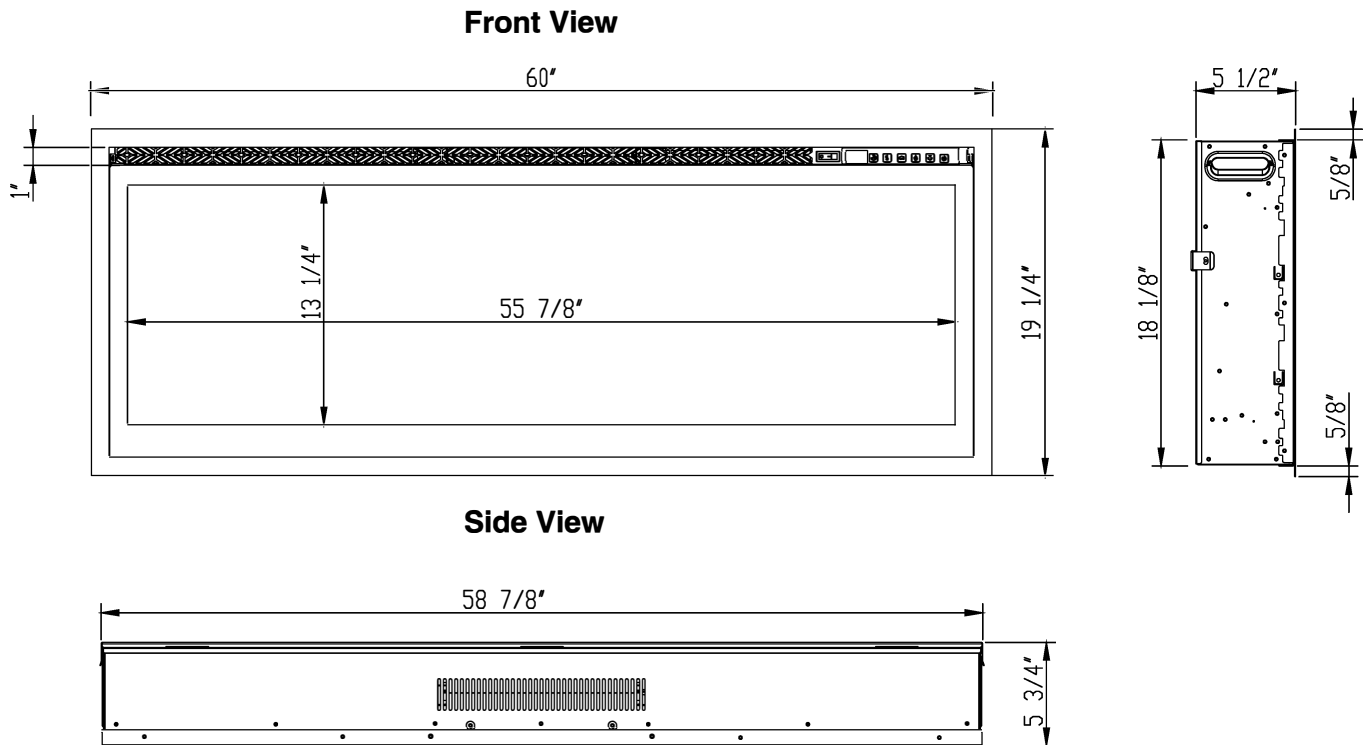

Features

- programmable thermostat
- 3 speed flame options
- 13 color media bed and 13 color flame options
- Designed for recessed mounting in wall
- Remote control for heat and flame setting(batteries not included)
- Dual mode ,operates with or without heat for only flame effect
- Built in timer 1 to 8 hours
- Faux drift wood fire logs and glass crystal media options

Sepecifications

- Frame color :black
- Watts:1400W
- BTU'S:4800
- Room Coverage:400 ft.
- Voltage::AC120V
- Amperes:12A

Dimensional Drawings

72" Dimensions

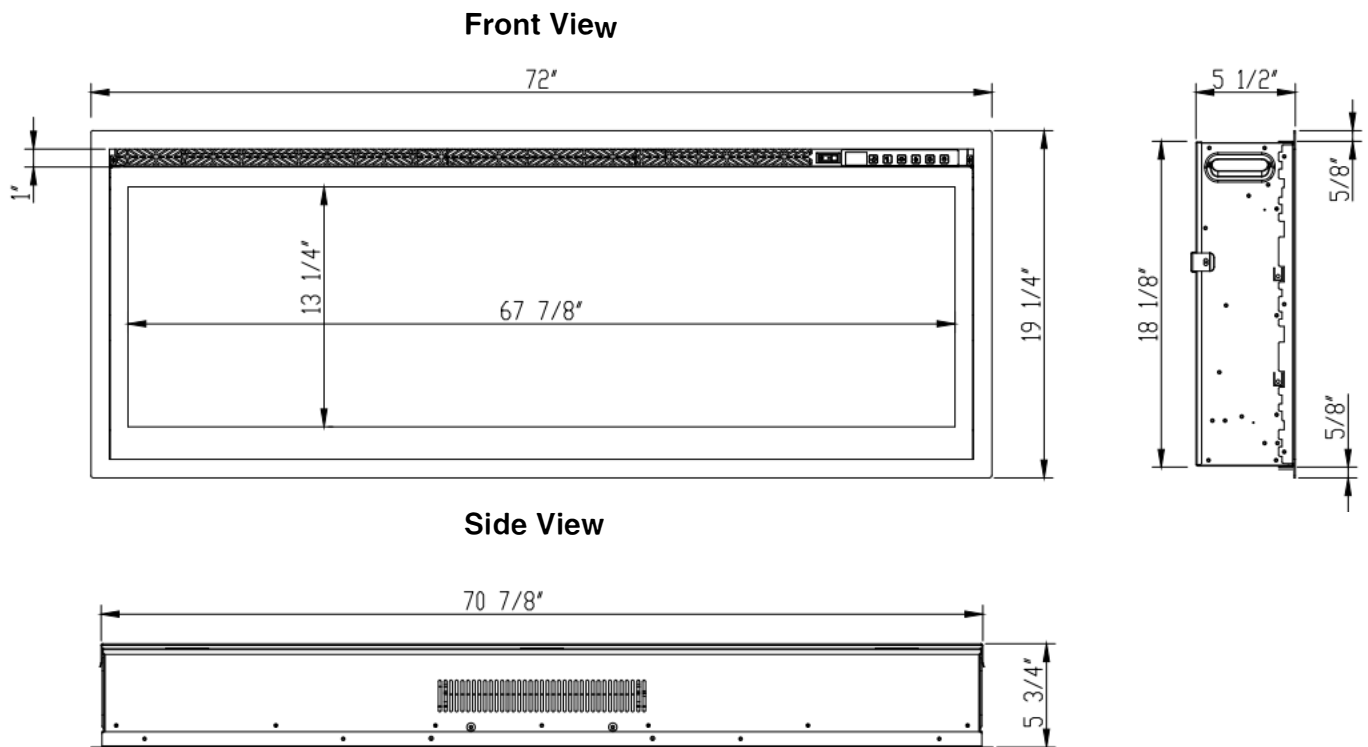

Features

- programmable thermostat
- 3 speed flame options
- 13 color media bed and 13 color flame options
- Designed for recessed mounting in wall
- Remote control for heat and flame setting(batteries not included)
- Dual mode ,operates with or without heat for only flame effect
- Built in timer 1 to 8 hours
- Faux drift wood fire logs and glass crystal media options

Sepecifications

- Frame color :black
- Watts:1400W
- BTU'S:4800
- Room Coverage:400 ft.
- Voltage::AC120V
- Amperes:12A





Unpacking Your Fireplace

Parts and Hardware

Tools Required

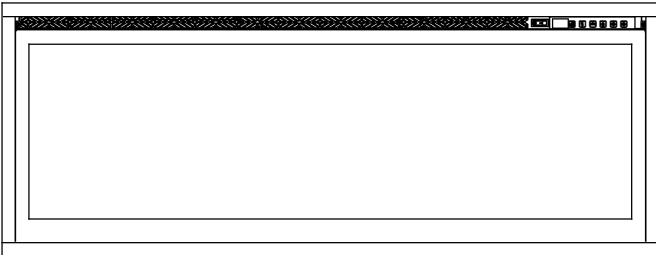
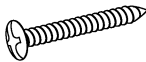
- Phillips screwdriver
- Stud finder
- Level
- Tape measure
- Electric drill
- 1/4" wood drill bit

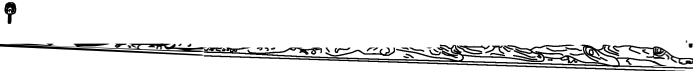
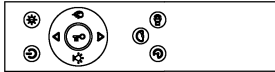
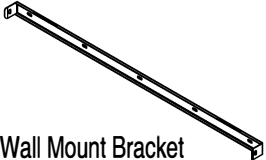
What's in the Box

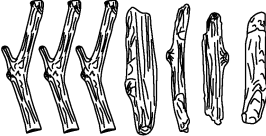
 <p style="text-align: center;">Fireplace</p>	 <p style="text-align: center;">Wood Screws-11Pcs</p>	 <p style="text-align: center;">Drywall anchors-11Pcs</p>
 <p style="text-align: center;">A whole piece of drift wood fire logs</p>	 <p style="text-align: center;">Remote Control</p>	 <p style="text-align: center;">Wall Mount Bracket (attached to back of fireplace)</p>
 <p style="text-align: center;">Crystal Embers</p>	 <p style="text-align: center;">Sectioned drift wood fire logs</p>	

Unpacking and Setup

Unpacking Instructions

- Remove all parts and hardware from the carton and place them on a clean, soft, dry surface. Check the parts list to make sure no parts are missing. If parts are missing, please contact our Email.

NOTE: Dispose of plastic bag, as it may cause choking hazard with young children. Do not let children play with plastic bag.

Wiring

This fireplace can be plugged into a grounded 3-prong outlet.

Testing the Fireplace Prior to Installation

- Before installing the fireplace, test the fireplace to make sure that it operates properly.
- Plug fireplace into approved outlet and power on fireplace. Once fireplace is tested, continue with installation.
- If you have any problems, please contact our Email

HOW TO TEST THE FIREPLACE : PLEASE PLUG IN THE UNIT AND TURN ON THE TOGGLE SWITCH FIRSTLY AND THEN CHECK THE FEARURES BY PRESSING THE CONTROL PANEL BUTTONS AS BELOW PICTURE SHOWING

"ON"Position

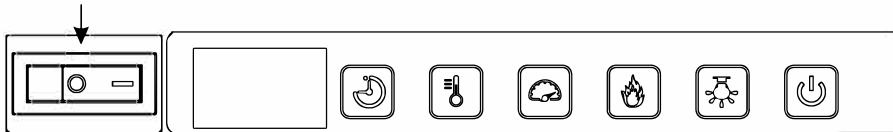

3-prong Outlet Installation

- Only use this fireplace on a 120V AC, 15-Amp grounded circuit. Never overload the circuit. If this fireplace trips the circuit breaker, unplug all other appliances on the same circuit before the next use. Avoid plugging other appliances into the same circuit as this fireplace.
- Always check the fireplace plug and connections before each use.
- Never plug this fireplace into an outlet that is cracked or has any loose wires or connections. Plugging this fireplace into a faulty outlet could result in the outlet overheating or catching fire.
- Always plug this fireplace into a wall outlet or receptacle. Never plug this fireplace into a surge protector, extension cord, or relocatable power tap.
- Make sure this plug fits securely into the outlet. Faulty wall outlet connections or loose plugs can cause the outlet to overheat. If the outlet or faceplate is hot, discontinue use immediately and have a qualified electrician inspect and/or replace the faulty outlet.
- The power cord supplied with the heater has three prongs: two flat blades (live and neutral) and one round pin (ground). If a 3-slot receptacle is not available, an adapter **MUST** be used. The adapter **MUST** be properly grounded to the outlet box (see figure below).

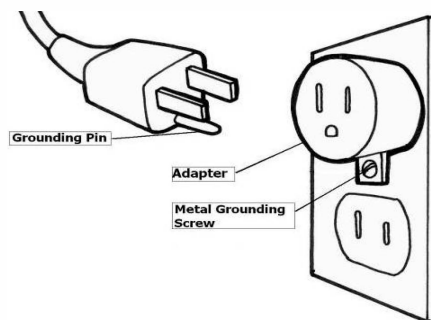

NOTE:ADAPTER NOT INCLUDED

Installation

WARNINGS

- Due to high temperatures, keep the fireplace out of high traffic locations.
- Keep combustible materials, such as furniture, pillows, bedding, papers, clothes, and curtains at least 36" away from the front of the fireplace.
- Never install the fireplace where it may fall into a bathtub or other body of water.
- Wear safety gloves and safety glasses for protection during installation. Broken glass may cause injury or harm.
- Prevent contact with loose insulation. Do not install the fireplace against a vapor barrier or exposed insulation.
- Do not expose the fireplace to the elements (rain, etc).

Choosing Installation Location

Choosing Wall Location

- Measure wall location to ensure that fireplace will fit on desired wall location.
- Minimum clearances (measurements taken from front of glass panel):.

Bottom of Fireplace to Floor: 6"	Top of Fireplace: 8" to mantel
Sides of Fireplace to Floor: 0"	Top of Fireplace: 8" to TV
Back of Fireplace to Floor: 0"	Top of Fireplace: 8" to ceiling

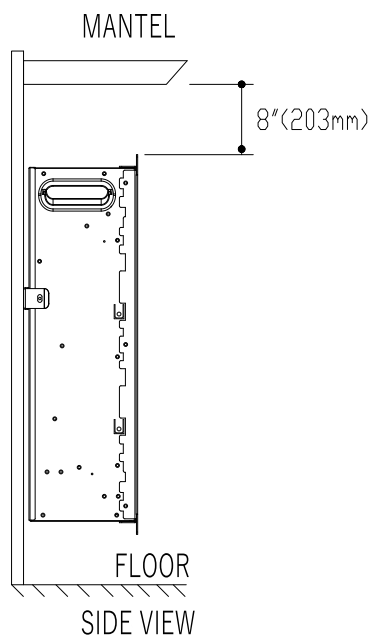

- Select a location that is not prone to moisture and is located at least 36" away from combustible materials such as curtains, drapes, furniture, bedding, or other combustible materials.
- See Safety Information on p. 4 for warnings about safe placement, safe installation, and proper use of this product.

Removing The Glass Panel

Remove the glass panel prior to installation. Please remove glass panel as per instructions below:

Instructions:

1. There are 2 screws in the top vent opening, one on the far left and one on the far right that secure the left and right trim pieces in place. Remove both screws to remove the trim pieces.

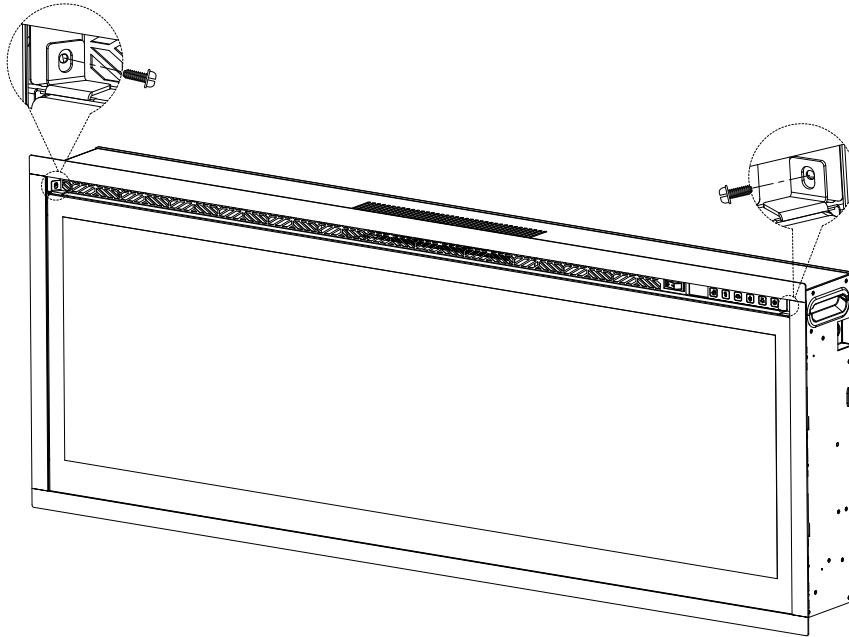

2. After removing screws, tilt glass panel away from the fireplace. Lift the glass panel away from the fireplace to remove the glass panel. Store the glass panel in a soft, dry place.

CAUTION: It is recommended that 2 people remove the glass panel to minimize chance of breakage.

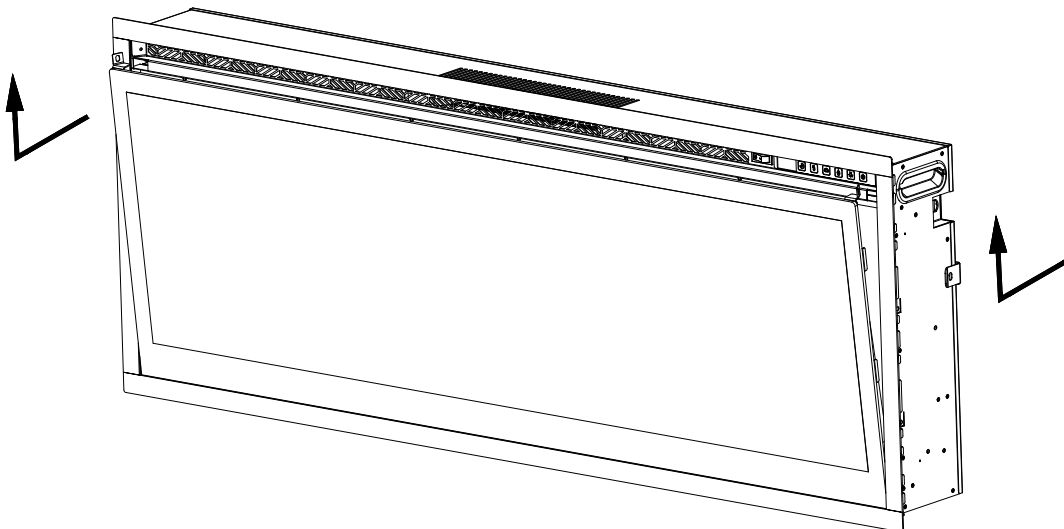

Recessed Installation

- Due to many different finish materials used on walls, it is highly recommended that you consult your local builder before you install this fireplace in the wall.
- Select a location that is not prone to moisture and is located at least 36" away from combustible materials such as curtains, drapes, furniture, bedding, or other combustible materials.
- In order to avoid the possibility of exposed insulation or vapor barrier coming in contact with the fireplace, it is recommended that the walls of the fireplace enclosure be "finished" (ie. Sheetrock, drywall, etc) as you would finish any other outside wall of your home. This will ensure that clearance to combustibles is maintained within the wall cavity.
- Never install fireplace into load-bearing walls. When recessing fireplace in a wall, recess into non-load bearing walls ONLY!

Instructions:

1. Choose a location in the wall to install fireplace.
2. Create opening in the wall that is no more than 1/4" larger than metal firebox portion of fireplace.

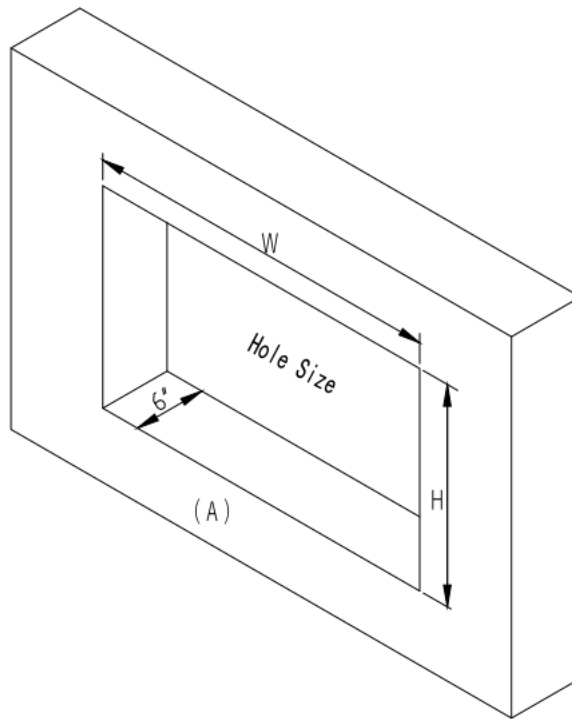

Framing Hole Size					
	W	H	W"	H"	H2"
50	49 1/4"	18 3/8"	7/8"	5 7/8"	4 7/8"
60	59 1/4"	18 3/8"	7/8"	5 7/8"	4 7/8"
72	71 1/4"	18 3/8"	7/8"	5 7/8"	4 7/8"

Recessed Installation - cont.

Once the fireplace is installed in the wall, place crystal embers or fire log in the fireplace. While both options are provided to the customer, only one option (crystals or log) should be installed.

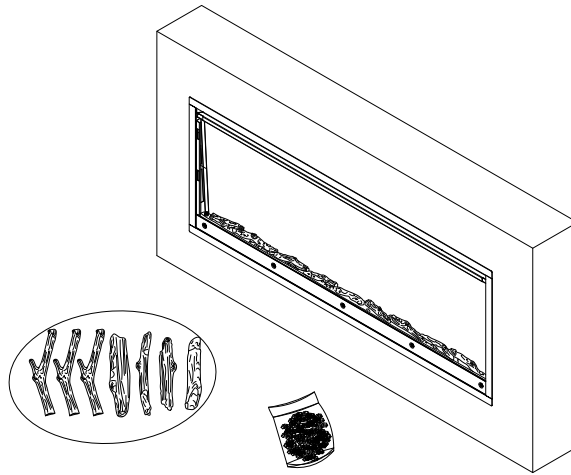

1. If it is necessary to replace the crystal stones or small artificial firewood decorations, first remove the EPE foam board that secures the artificial firewood, then take off the log head screws that fix the artificial firewood at both ends.

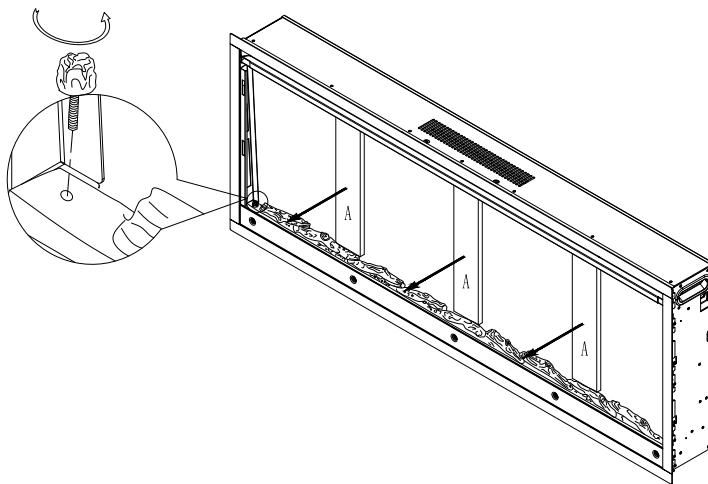

2. Spread the crystal stones



Reinstalling the Glass Panel

Once completed installing crystal embers or fire log, you are now ready to reinstall the glass panel.

1. Fit the bottom of the glass panel into the slot in the bottom of the firebox (A). Once in place, push the top of the glass panel back toward the firebox (B).

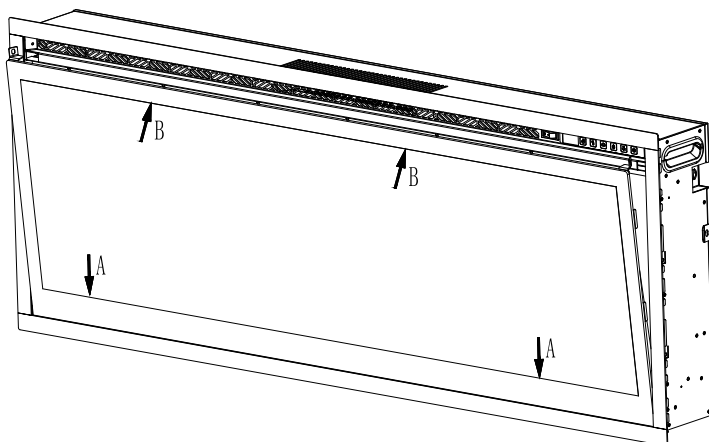

2. Once the glass panel is in place, secure the glass panel to the firebox using the 2 screws removed in Remove the Glass Panel section.

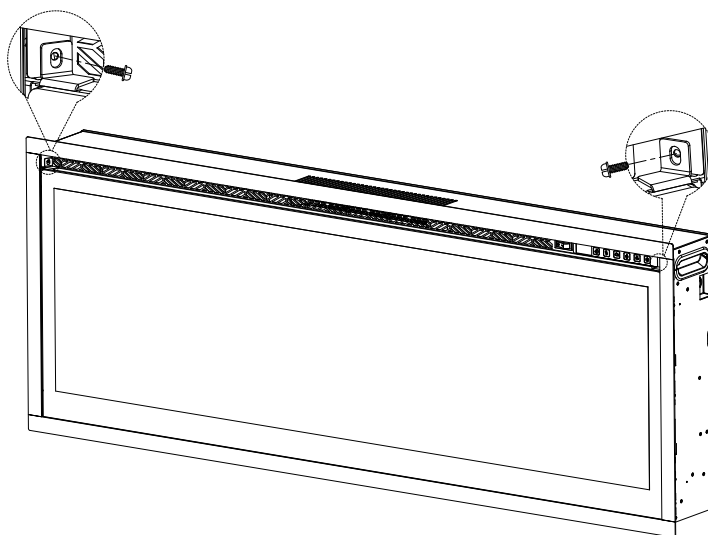

Your fireplace is now ready for use

Wall Mounted Installation

- Due to many different finish materials used on walls, it is highly recommended that you consult your local builder before you install this fireplace on the wall.
- Select a location that is not prone to moisture and is located at least 36" away from combustible materials such as curtains, drapes, furniture, bedding, or other combustible materials.

Instructions

1. Select a location that is not prone to moisture and is located at least 36" away from combustible materials, such as curtains, drapes, furniture, bedding, paper, etc.
2. With glass panel removed (see p.11 for instructions on removing glass panel), have two people hold the fireplace against the wall to determine the final location.
3. Place the unit face down on a soft, non-abrasive surface. Remove the bracket from the back of the unit by removing the screws holding the bracket to the back of the fireplace

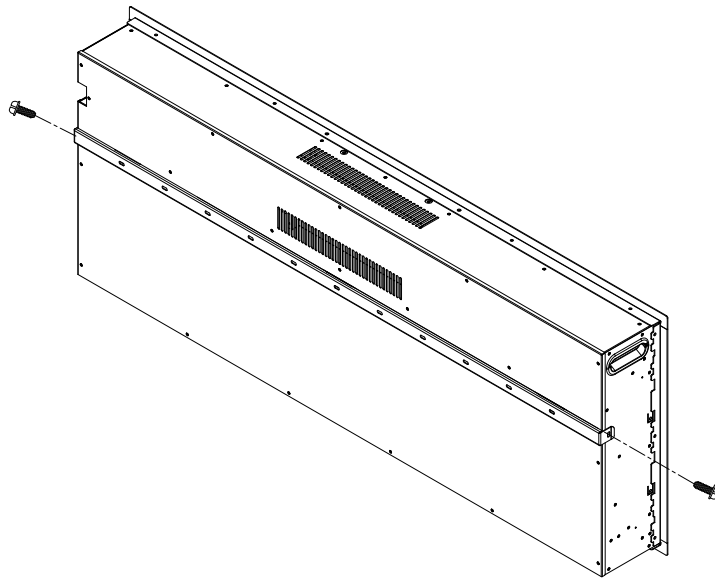

Wall Bracket Removal (1 bracket)

Wall Mounted Installation - cont.

4. Mark location of bracket on wall and then mount the bracket to the wall using the supplied screws and dry wall anchors. The hooks in the bracket MUST be pointed away from the wall, upward, and level.

Note: Mount bracket to at least 2 studs. If 2 studs cannot be used, ensure that the supplied dry wall anchors are used to affix the bracket to the wall and the bracket is adequately secured before moving to the next step

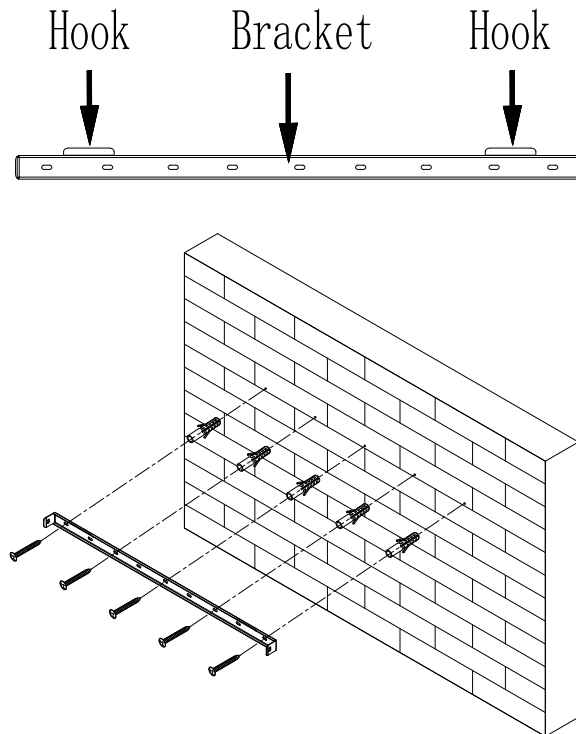

5. With the wall mounting bracket installed, have 2 people lift the fireplace up and insert the 2 hooks on the bracket into the back of the fireplace. The 2 hooks on the mounting bracket will line up with the 2 holes on the back of the fireplace. Once aligned, the hooks will insert into the holes in the back of the fireplace and lock in the down position.

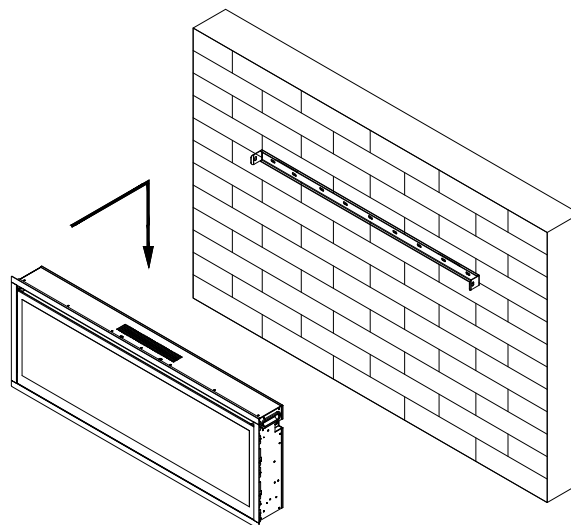

Wall Mounted Installation - cont.

6. Check the fireplace for stability, ensuring that the bracket will not pull free from the wall. Once satisfied, install crystal embers/fire log and reinstall glass panel.

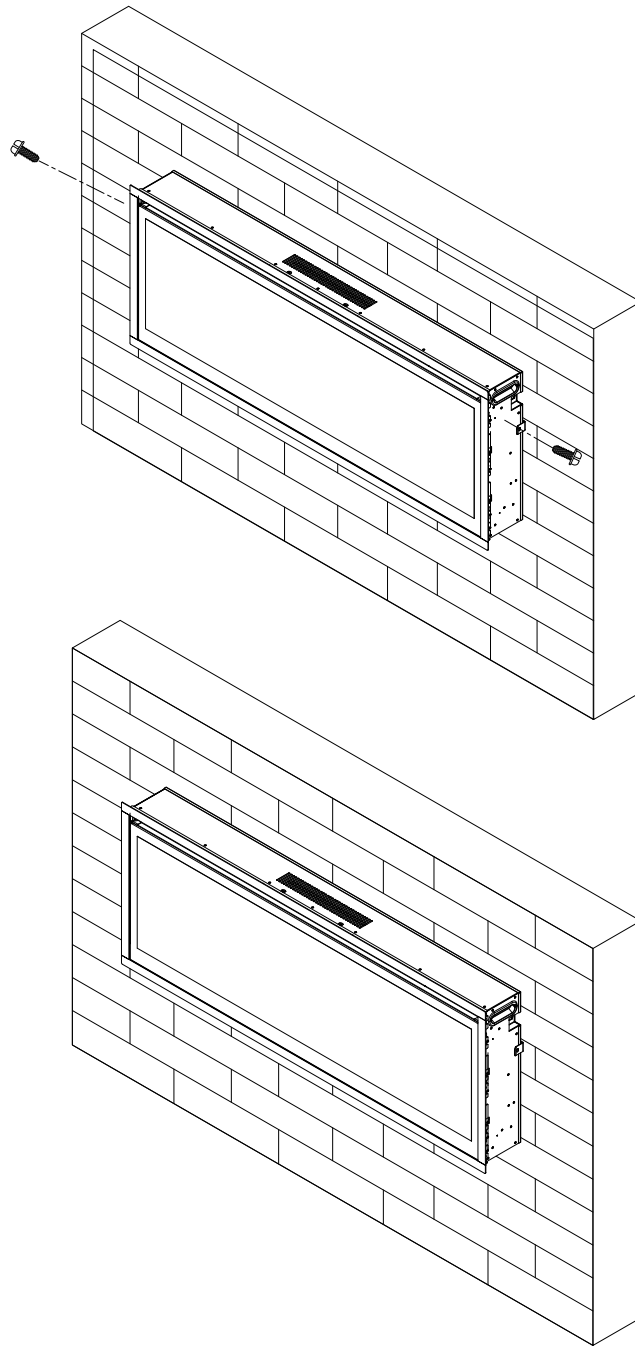

Complete the installation

Operating Fireplace

Once the fireplace has been plugged into a grounded outlet, the fireplace is now ready for operation. Ensure that the house circuit breakers for the power supply are turned on.

Power

Plug the power cable into a 110v 15 amp grounded outlet. Make sure the outlet is in good condition and that the plug is not loose. **NEVER** exceed the maximum amperage for the circuit. **DO NOT** plug other appliances into the same circuit. Always plug this fireplace into a wall outlet or receptacle. Never plug this fireplace into a surge protector, extension cord, or relocatable power tap.

Methods of Operation

This electric fireplace can be operated by the CONTROL PANEL, located in the upper righthand corner of the fireplace, or by the WIRELESS REMOTE CONTROL. The operation and functions of both methods are the same. CAUTION: For safety and energy efficiency, the Toggle Switch must be in the ON position before any subsequent operations can be initiated.

Control Panel

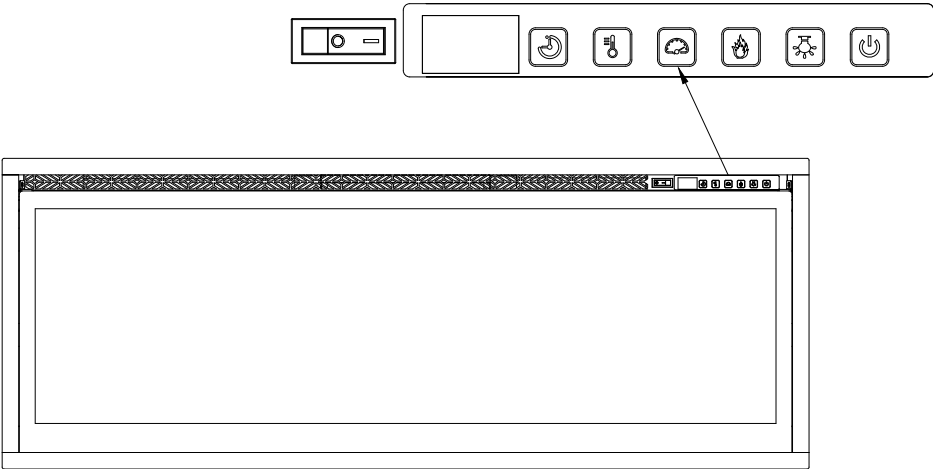





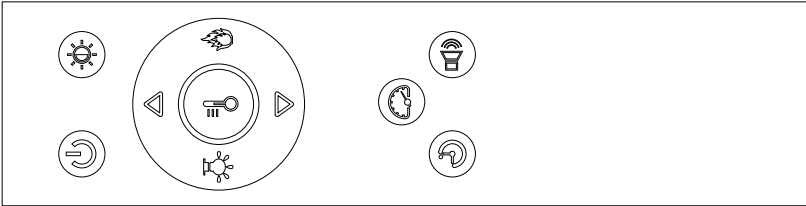















Wireless Remote Control

Note: Battery not included
Recommended: AAA batteries



Method of Operation - cont.

Control Panel & Wireless Remote Control Functions

Control Panel			Wireless Remote Control		
BUTTON	FUNCTION	ACTION & INDICATION	BUTTON	FUNCTION	ACTION & INDICATION
	Power	1. Press once. Power turns on. 2. Press again. Flame effect turns off. Unit goes to standby.		Power	1. Press once. Power turns on. 2. Press again. Flame effect turns off. Unit goes to standby.
	Flame	1. Press once to change the flame color. 2. Press again until desired setting is reached. There is a total of 13 different flame color combinations		Flame	1. Press once to change the flame color. 2. Press again until desired setting is reached. There is a total of 13 different flame color combinations
	Ember color	1. Press once to change the ember color. 2. Press again until desired setting is reached. There is a total of 13 different ember color combinations.		Ember color	1. Press once to change the ember color. 2. Press again until desired setting is reached. There is a total of 13 different ember color combinations.
	Speed	1. Press once to change the flame speed. 2. Press again until desired setting is reached. Display shows the setting. There are 3 flame speed settings.		Speed	1. Press once to change the flame speed. 2. Press again until desired setting is reached. Display shows the setting. There are 3 flame speed settings.
	Timer	1. Press once timer increases to 1 hour. Settings range from 1 to 8 hours		Timer	1. Press once timer increases to 1 hour. Settings range from 1 to 8 hours
	Heater	Turns heater on and off. Press and hold for 3 seconds to enter the temperature adjustment mode.		Heater	Turns heater on and off.
	Flame brightness	Press and hold for  3 seconds to adjust the brightness		Flame brightness	Adjust the brightness in 5 levels
	Play Sound	Press and hold  for 3 seconds to play sound.		Play Sound	Adjust the firewood crackling sound volume in 3 levels
				UP	Raise the temperature (62°F→86°F→ON)
				DOWN	Decrease the temperature (On→86°F→62°F)

Using The Remote Control

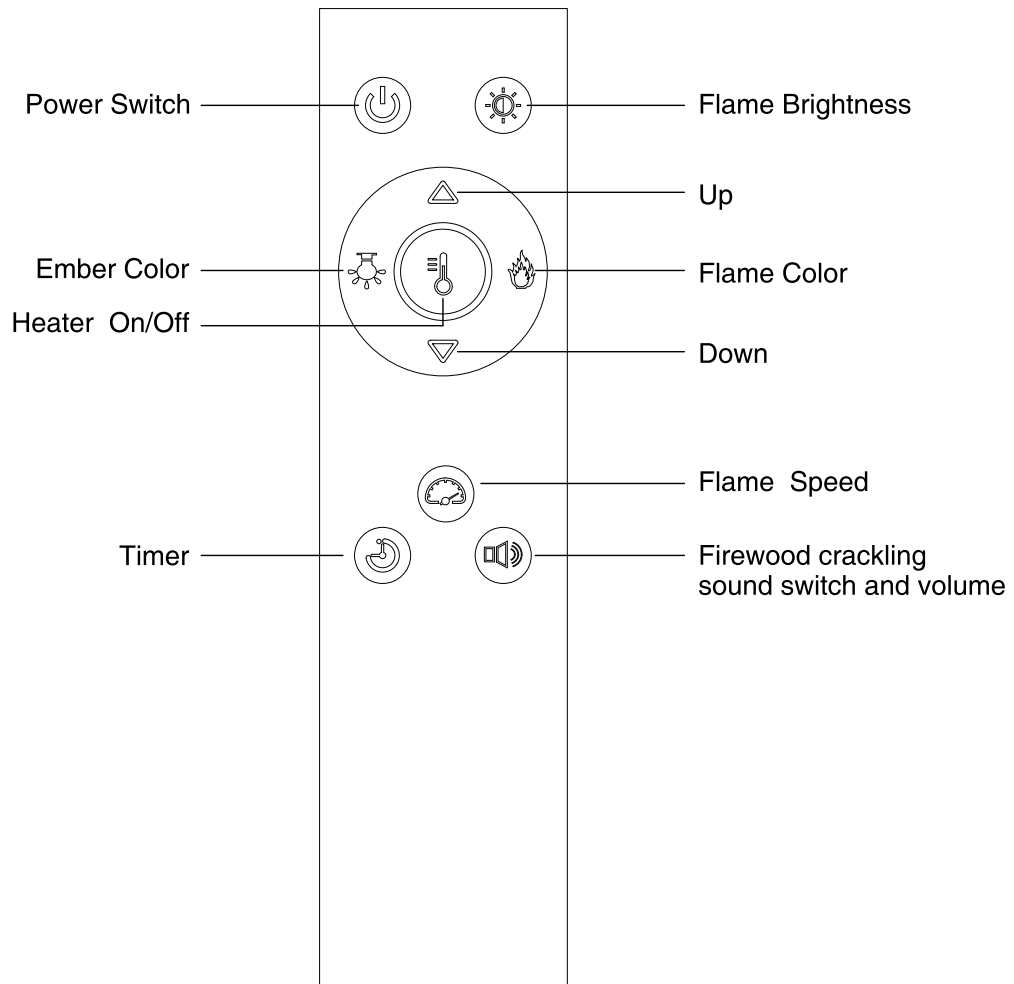

Connect To App

Use the App to control your electric fireplace from your iPhone or Android device even when you are away from home.

SYSTEM REQUIREMENTS

- Supported wireless routers must have a 2.4 GHz operating frequency
- Standard:802.11b/g/n bands
- Supported smartphone systems:Android 6.0 or later iOS 11 or later

Step 1

Search in Apple's App Store and other major app stores

If you have issues downloading the app, please call technical support or email customer service.

Step 2

Open the app,turn on Bluetooth,then sign up for a free account.Log in with your account name and password

Connect To App

Step 3

Select your WIFI network and enter the password. The network must be 2.4 GHz

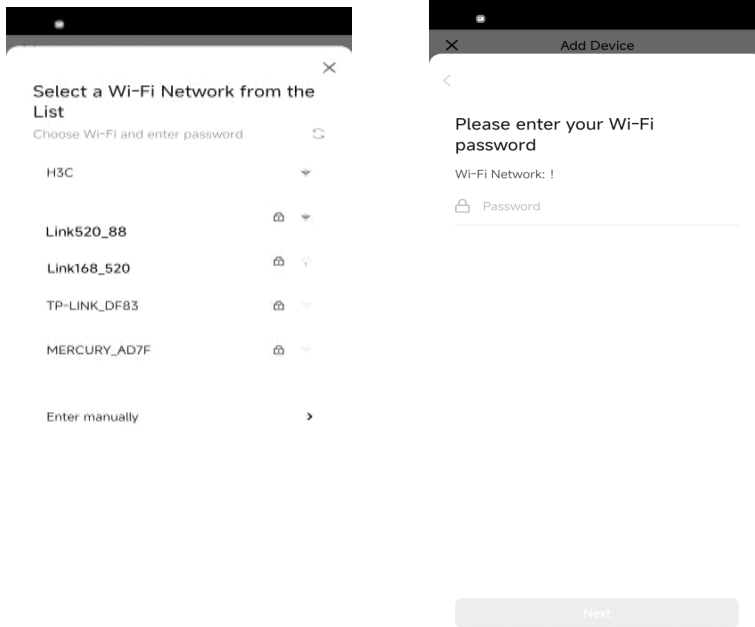

Step 4

When the electric fireplace is plugged in, press and hold the Timer button on the control panel for 5 seconds while it is in the off state. The display screen will show "P0" and flash, indicating entry into the network configuration mode. If the network configuration is successful, the display screen will show "P1"; if the network configuration fails, the display screen will show "P0" (flashing) and exit after a period of time.

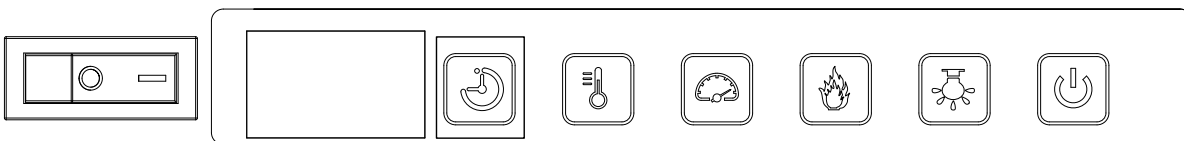

Hold the Timer button on the control panel for 5 seconds while it is in the off state.

Connect To App

Step 5

Open the app, then select the ADD DEVICE button. The app will search for the fireplace automatically. Press the green ADD DEVICE button to add your device.

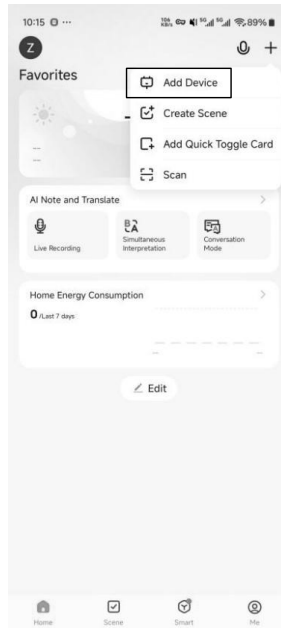

Step 6

Choose your Wi-Fi name (the one your phone is connected to) and enter the password. Press the "Next" button to continue.

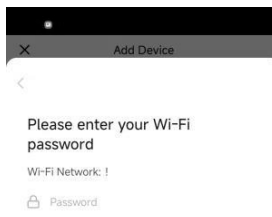

Note: Please have your Wi-Fi password ready before network configuration to facilitate subsequent network setup operations.

Connect To App

Step 7

The app starts connecting to your fireplace. It may take some time, but please wait patiently to set up the connection.

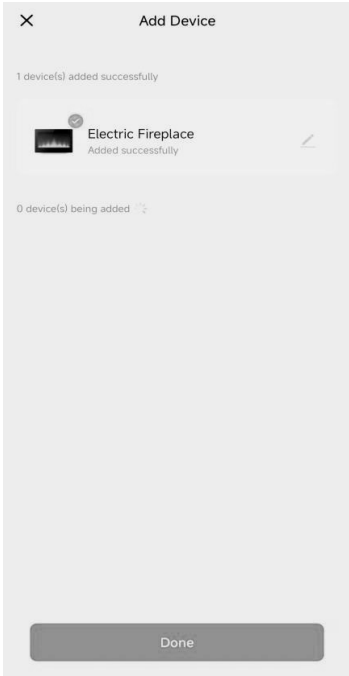
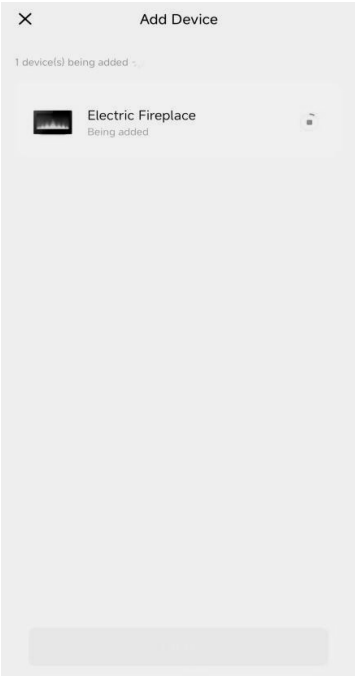
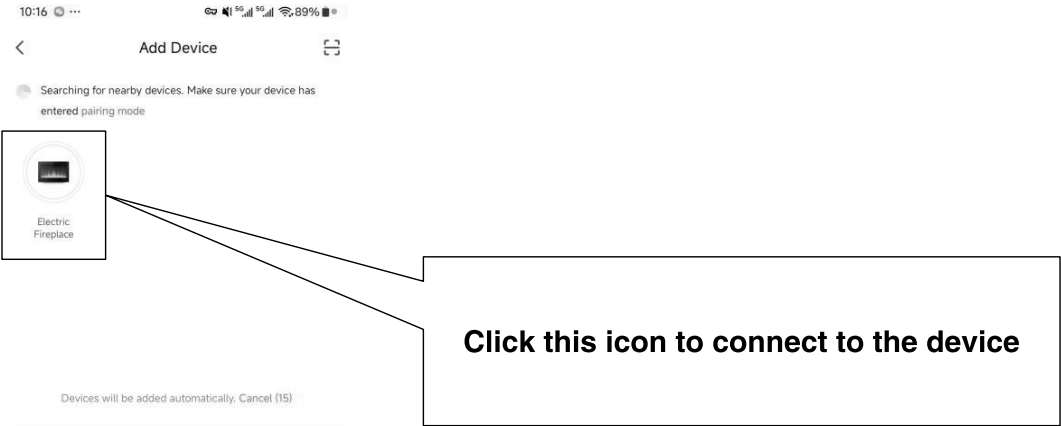

Using The App

Switch Between Celsius/fahrenheit

Child Lock
(if the child lock is on, The temperature adjustment feature is disabled)

Temperature Adjustment

Flame Brightness

Flame Speed

Firewood crackling sound switch and volume

Flame color

Ember color

Timer

Power Switch

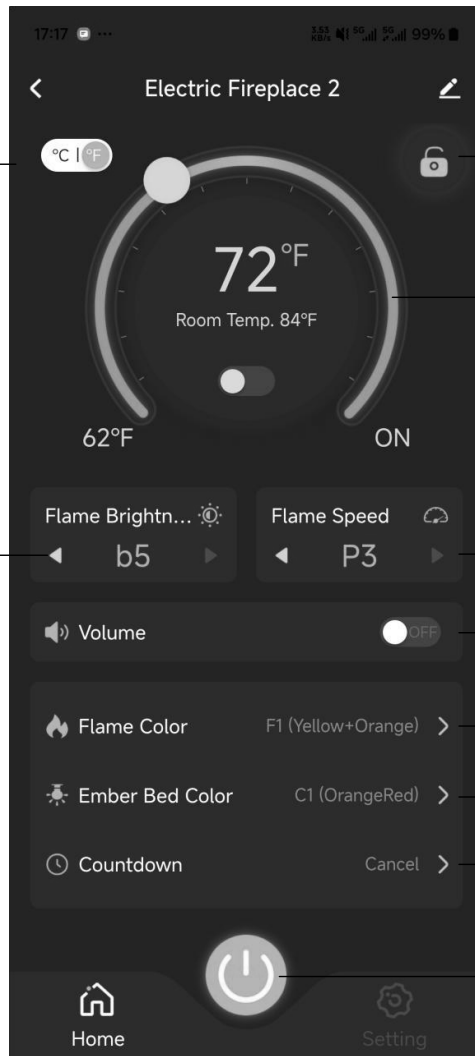

Using The App

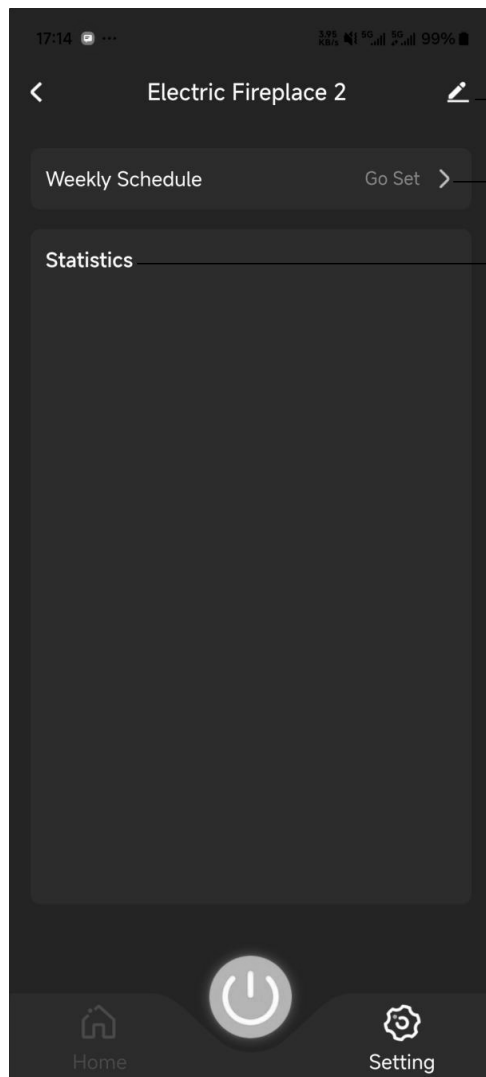

Edit the name of the electric fireplace device

Weekly schedule setting function

The power consumption of the electric fireplace

WARRANTY CARD

Your warranty includes

- **30 Days Money Back Guaranty**

Within the first 30 days of your purchase, you are allowed to return your product for a full refund.

- **30 Days to 3 Months(6 Months)**

We will replace the defective unit due to manufacturer fault with a new one. (You will receive extra 3 Months warranty if you register on our website.)

- **3 Months to 24 Months**

Within 24 Months, we will provide timely and effective online after-sales service after your purchase.

How to return your Products

- Contact with your order number.
- We will issue you RMA # and return address for your return.
- Please fill out RMA info, tear off this page and leave it inside your return package.
- We will issue replace / return after receiving your return.

Return product details

To get your returns processed as quickly as possible, please fill this form and include it in your return package.

Purchase Name	
Order Number	
Date of Purchase	
Your Email Address	
Where did you buy it	

MADE IN CHINA

