

BATHROOM CABINET

Assembly Instructions - Please keep for future reference

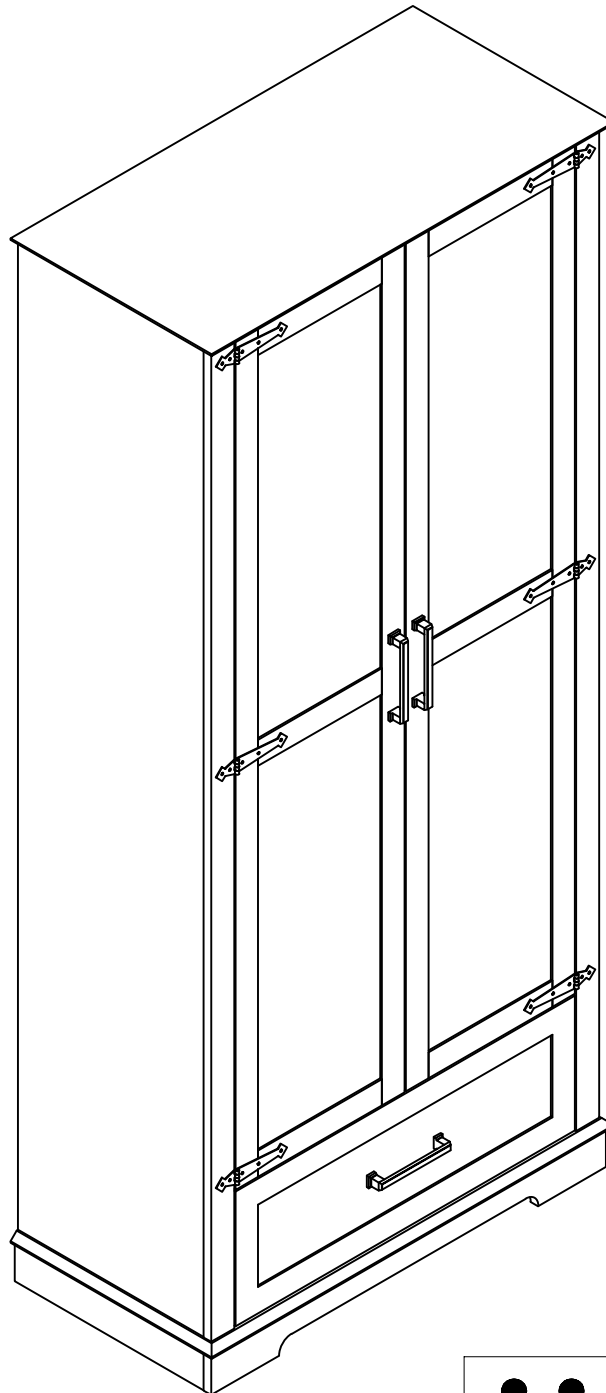

Two people are required to assemble and move this model.

Important – Please read these instructions fully before starting assembly

Safety and Care Advice

Important – Please read these instructions fully before starting assembly

- Check you have all the components and tools listed on the following pages.

- Remove all fittings from the plastic bags and separate them

- Keep children and pets away from the installation area, which may cause choking if small parts are swallowed.

- Make sure you have enough space to layout the parts before

- Do not stand or apply weight to the product during assembly. This may cause damage.

- Assemble the item as close to its final position (in the same room) as possible.

- Assemble on a soft level surface to avoid damage to the unit or floor.

- It's easier for two people to assemble the parts together.

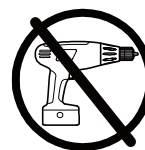

- To reduce the likelihood of damage to your product, make sure your power drill is set to a low torque setting

Care and maintenance

- Only clean using a damp cloth and mild detergent, do not use bleach or abrasive cleaners.

- Check for loose screws on this unit from time to time.

- This product should not be discarded with household waste. Take to your local authority waste disposal centre.

Handy Hints

- Assemble all parts and bolts loosely during assembly, only once the product is complete should you fully tighten the bolts

- Regularly check and ensure that all bolts and fittings are correctly tightened.

WARNING

In order to help prevent overturning – please follow these instructions

To help prevent product toppling over please follow the below steps:-

Use the anti tip strap or wall fixing method provided (if applicable)

Do not allow children to climb or hang on the furniture

Do not open more than one drawer at a time

Do not place heavy items in the top drawers

Do not place heavy items on top of the furniture, unless the furniture has been designed for this purpose

please note that only the anti tip strap is provided.

You will need to provide wall plugs and screws applicable for your wall type

Using Camlocks

Step 1

Connect the male camlock as directed in the assembly instructions using a screwdriver.

1 DO NOT OVER TIGHTEN.

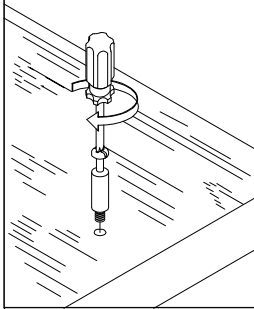

Step 2

Push the male camlock into the entry hole.

2

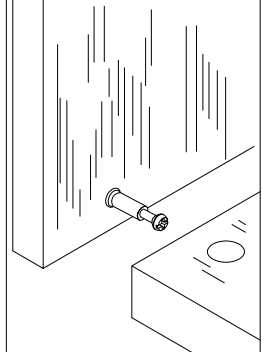

Step 3

Insert the female camlock as shown in the instruction.

Note: ensure that the arrow on the top of the camlock points towards the entry hole for the male camlock.

3

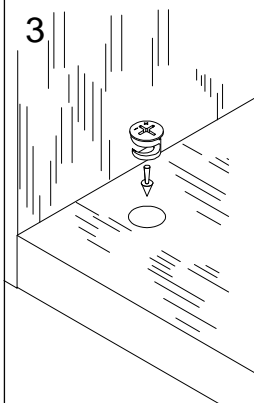

Step 4

Turn the female camlock clockwise with a screwdriver.

You should feel a click when the camlock is locked in place.

The joint is now secure.

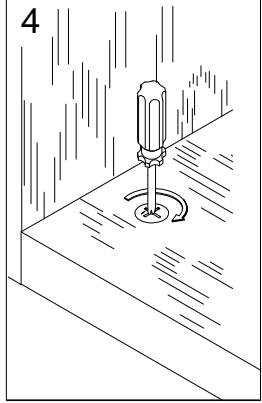

4

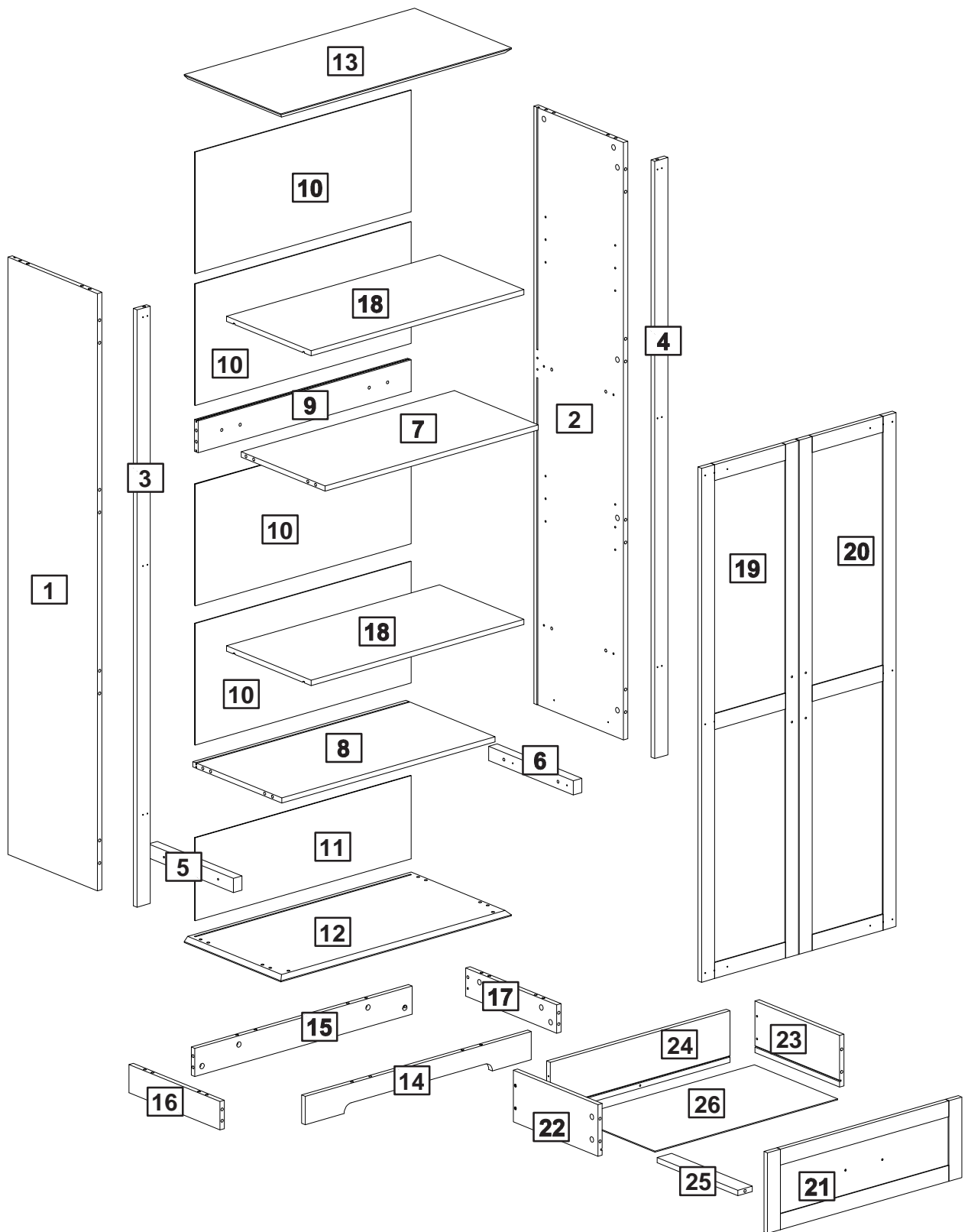

Assembly Instructions



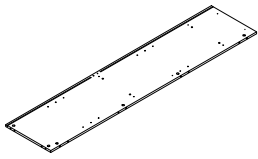
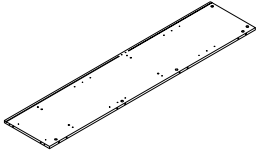
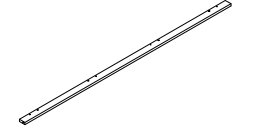
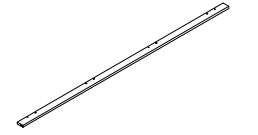
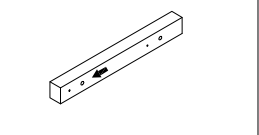
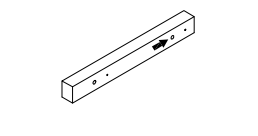
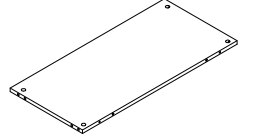
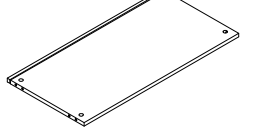
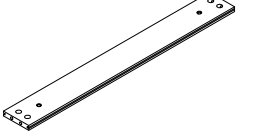
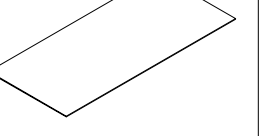
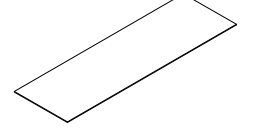
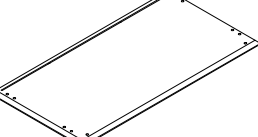
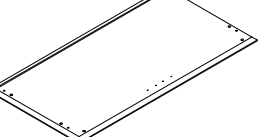
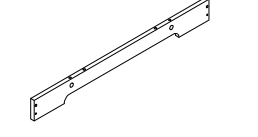
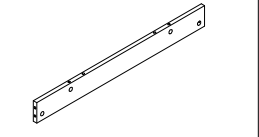
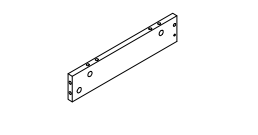
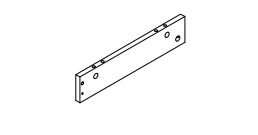
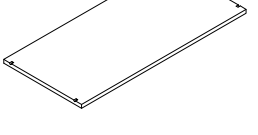
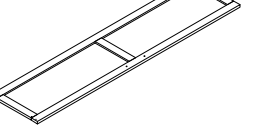
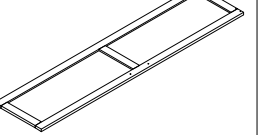
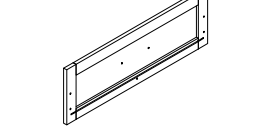
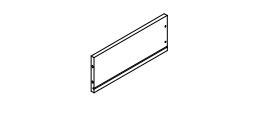
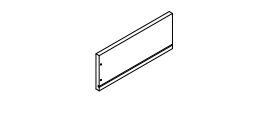
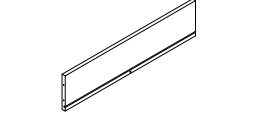
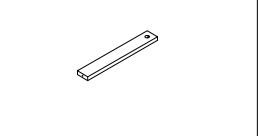
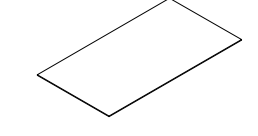











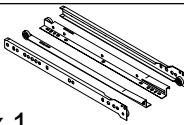

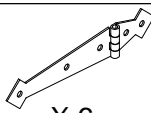

Part List: WF326355AAK

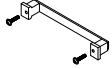
| | | | | |
|--|--|--|---|--|
|  1 PCS |  1 PCS |  1 PCS |  1 PCS |  1 PCS |
|  1 PCS |  1 PCS |  1 PCS |  1 PCS |  4 PCS |
|  1 PCS |  1 PCS |  1 PCS |  1 PCS |  1 PCS |
|  1 PCS |  1 PCS |  2 PCS |  1 PCS |  1 PCS |
|  1 PCS |  1 PCS |  1 PCS |  1 PCS |  1 PCS |
|  1 PCS |  Hardware 1 PCS | | | |

Hardware list:

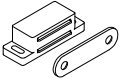
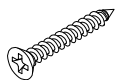
Please check you have all the panels listed below

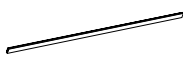
Note: The quantities below are the correct amount to complete the assembly. In some cases more fittings may be supplied than are required.

| | | |
|--|---|--|
| <p>A  Male Camlock x 41</p> | <p>B  Female Camlock x 41</p> | <p>C  Dowel (8x30) x 42</p> |
| <p>D  14" x 1</p> | <p>E  6*48mm Screw x 6</p> | <p>F  X 6</p> |
| <p>G  3.5*14mm Screw x 30</p> | <p>H  3*14mm Screw x 12</p> | <p>I  Plastic wedge x 16</p> |
| <p>J  3*16mm Screw x 20</p> | <p>K  x 2</p> | <p>L  x 1</p> |
| <p>M  Shelf Support Pin x 8</p> | <p>N  Ø20 Sticker x 20</p> | <p>O  Magnet Touch x 2</p> |
| <p>P  4*30mm Screw x 9</p> | <p>Q  Hex Key M4 x 1</p> | <p>R  739mm x 2</p> |
| <p>S  Wall Fixing Pack x 2</p> | | |
| | | |
| | | |
| | | |



Ruler - Use this ruler to help correctly identify the screws

0 5 10 15 20 25 30 35 40 45 50 55 60 65 70 75 80 85 90 95 100 105 110 115 120 125 130 135 140 145 150 155 160 165 170



The screws length is measured from the head to the point (30mm screw shown).

Assembly Instructions

Step 1

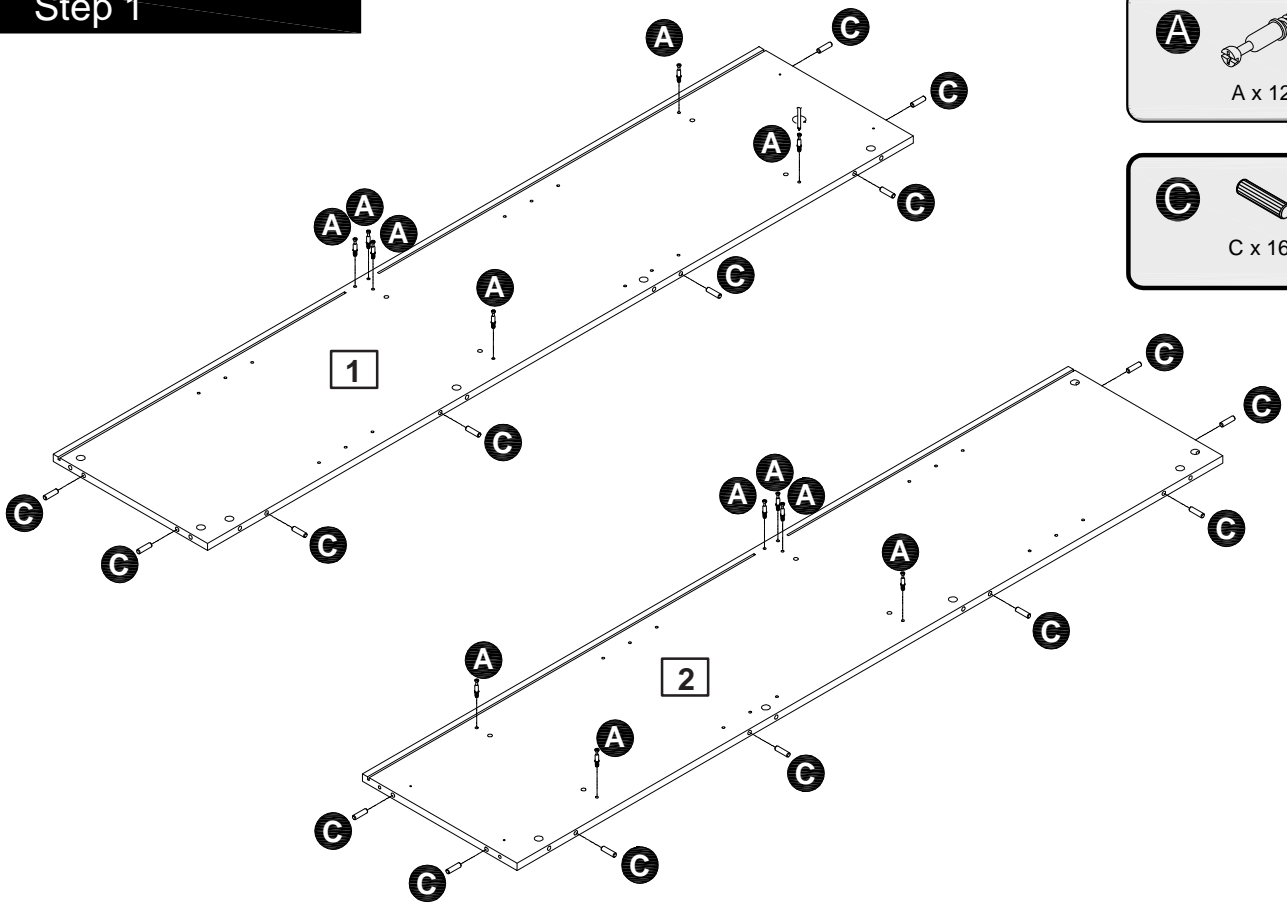

Step 2

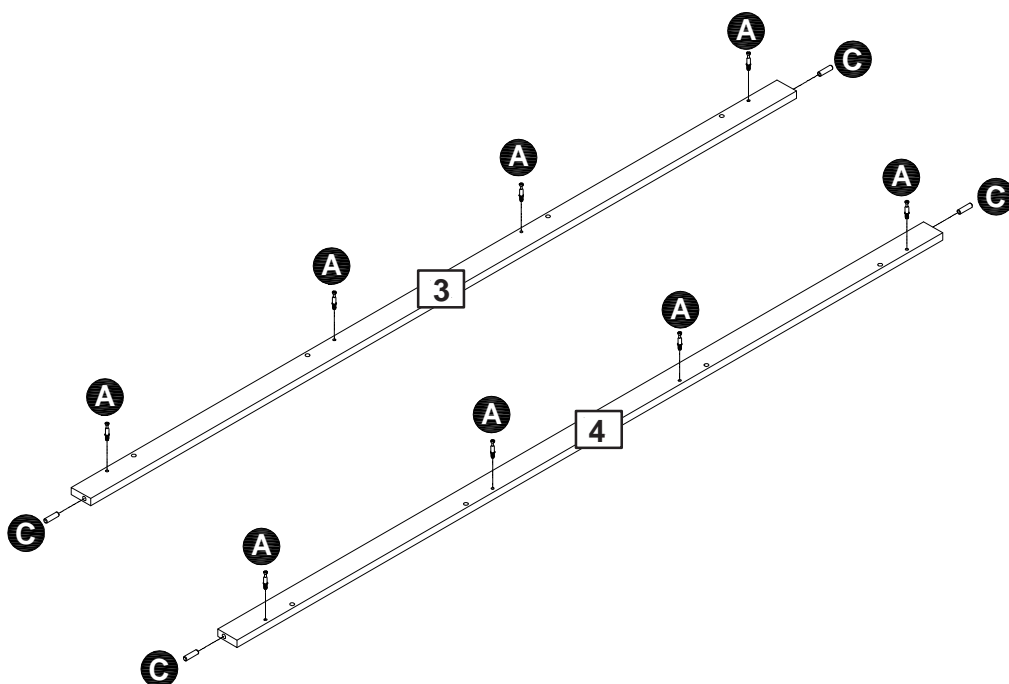

Assembly Instructions

Step 3

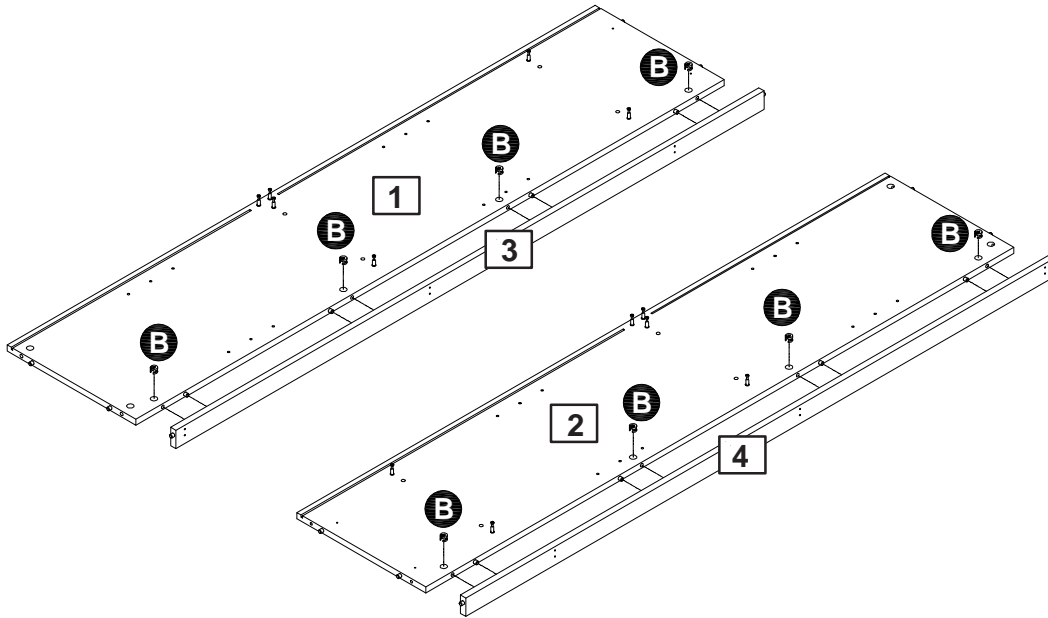
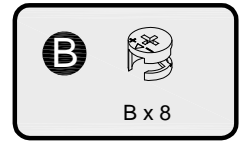
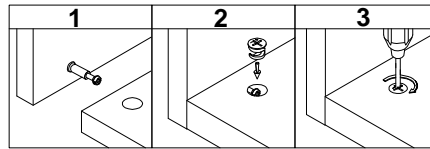

Step 4

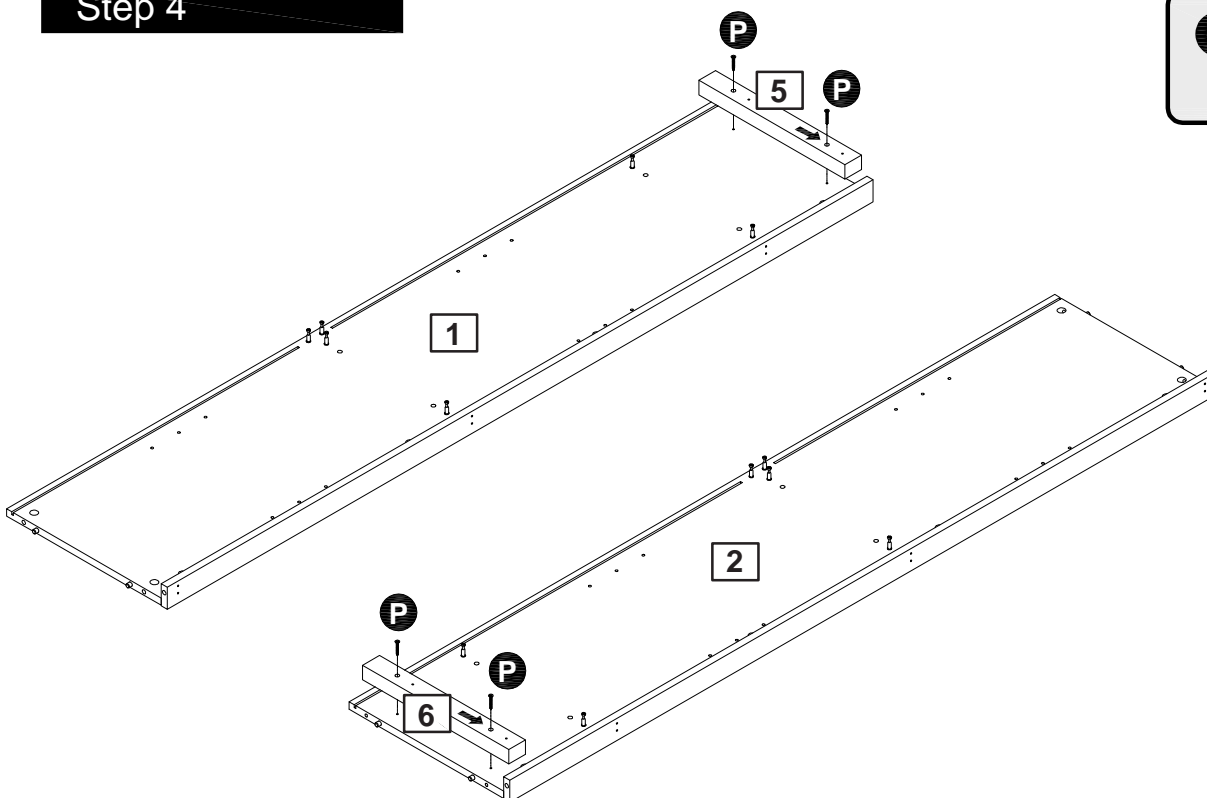
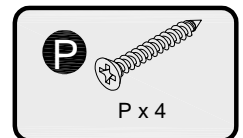

Assembly Instructions

Step 5

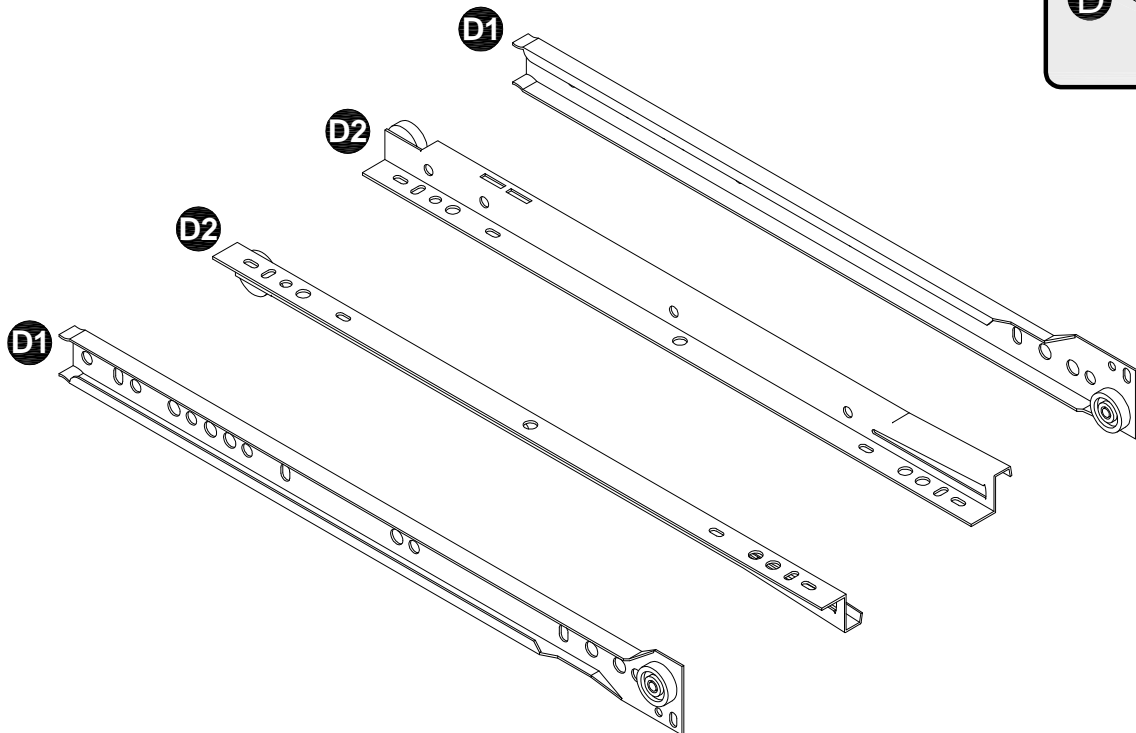

D1 installed on No.1 and 2(Step6)
D2 installed on the bottom of the drawer.(Step 28)

Step 6

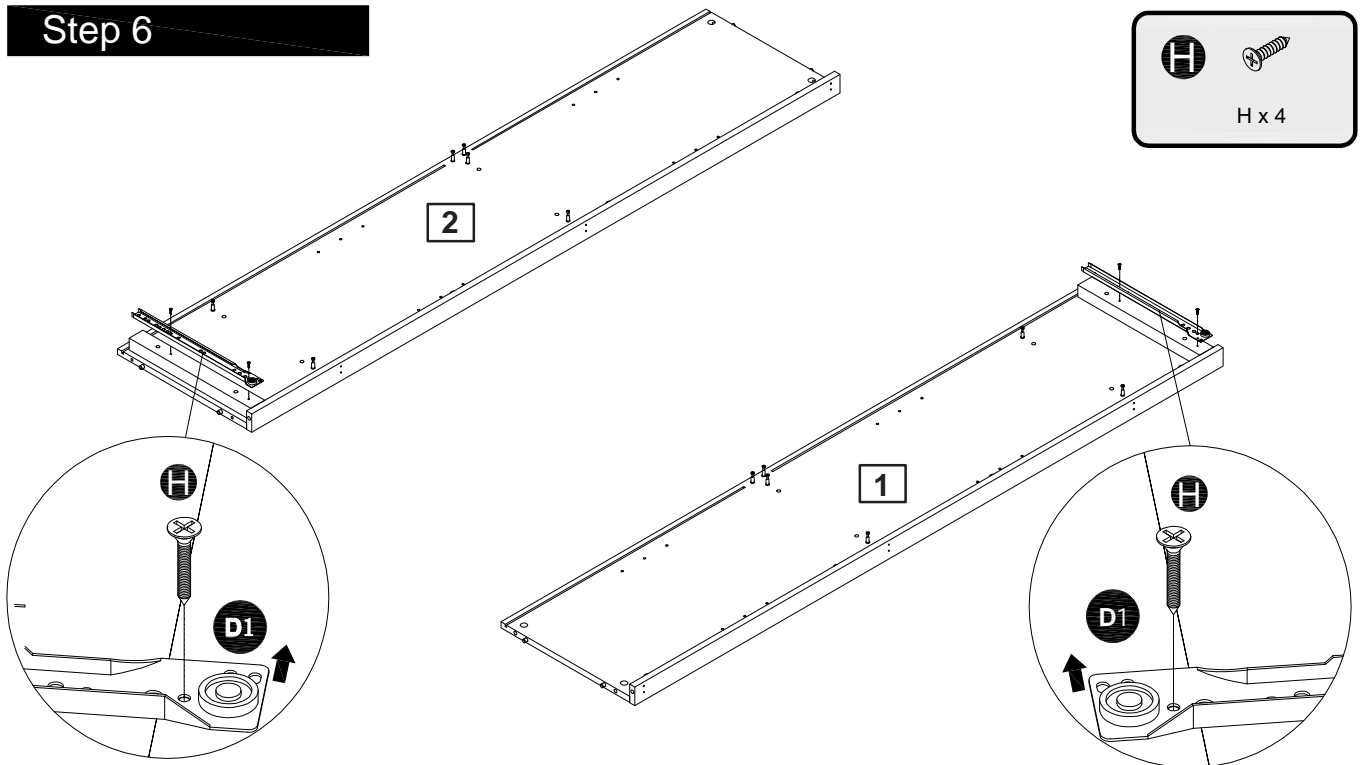

Assembly Instructions

Step 7

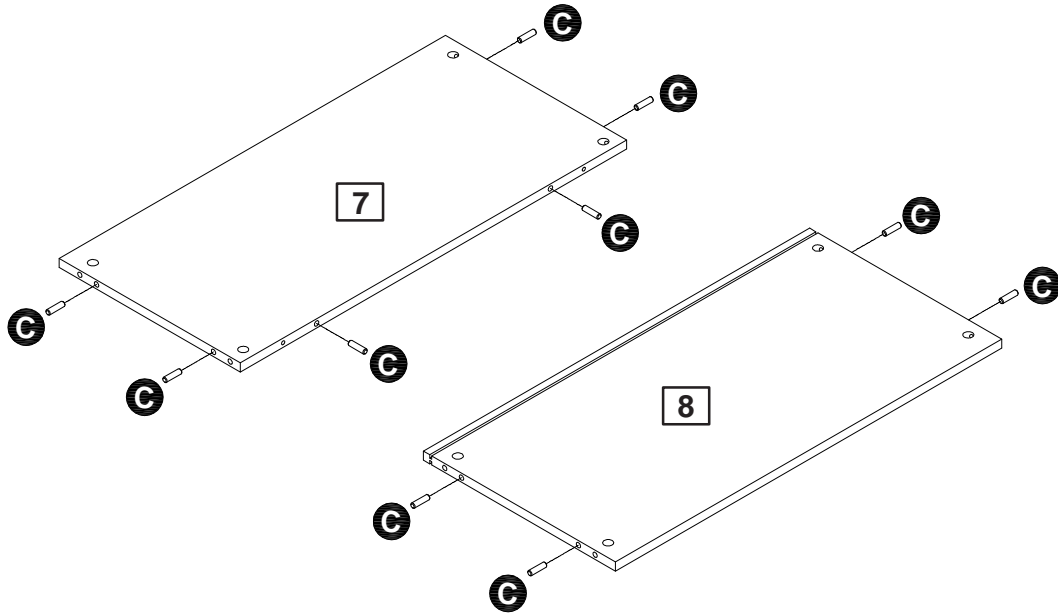

Step 8

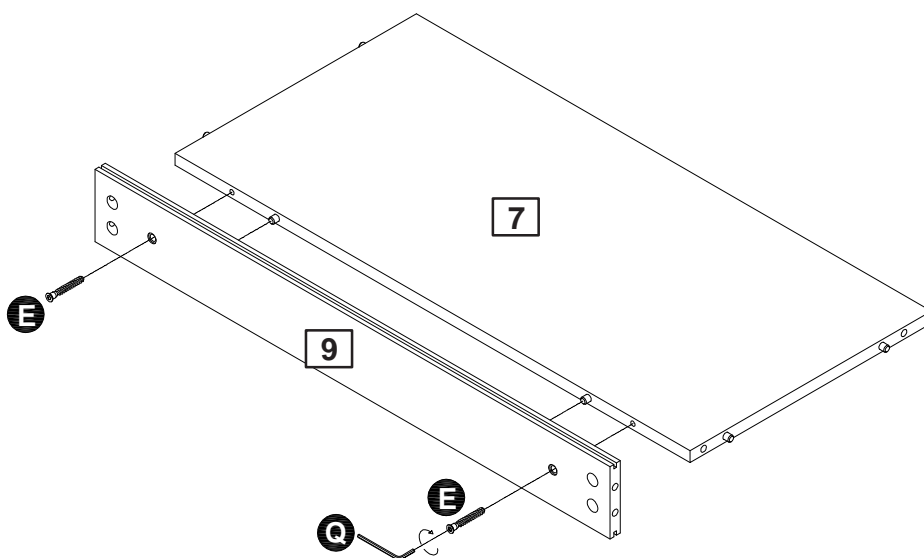
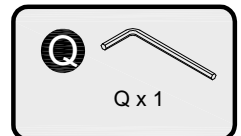

Assembly Instructions

Step 9

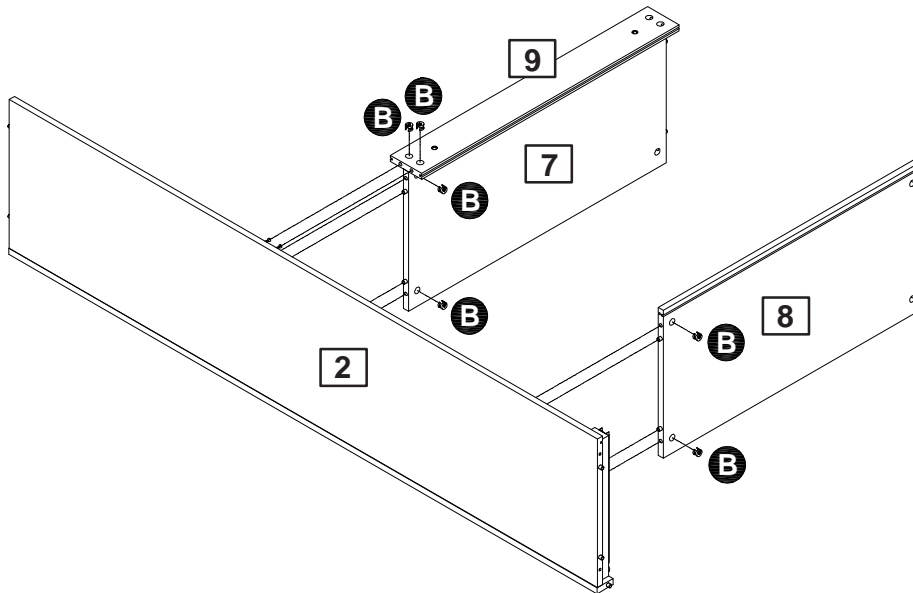
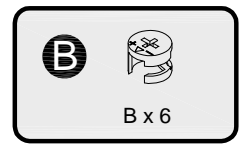
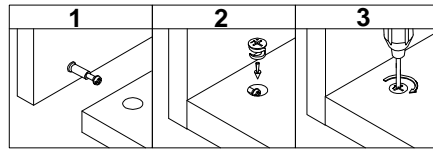

Step 10

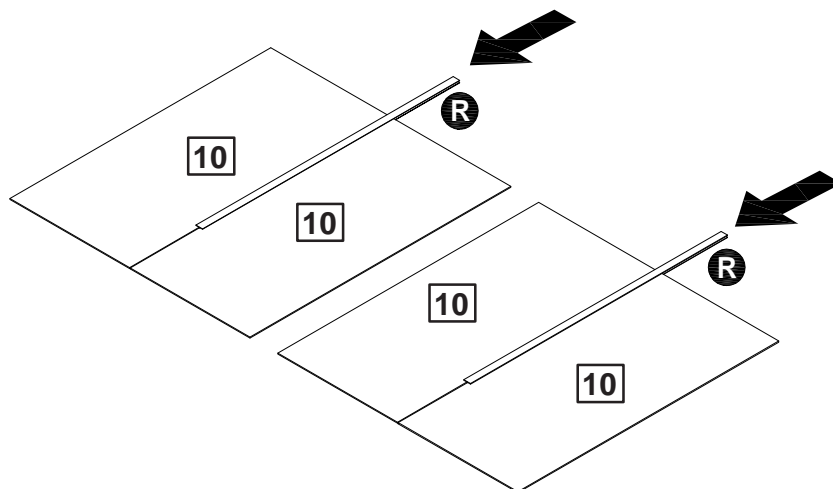
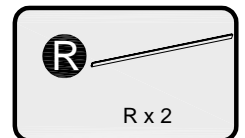

Assembly Instructions

Step 11

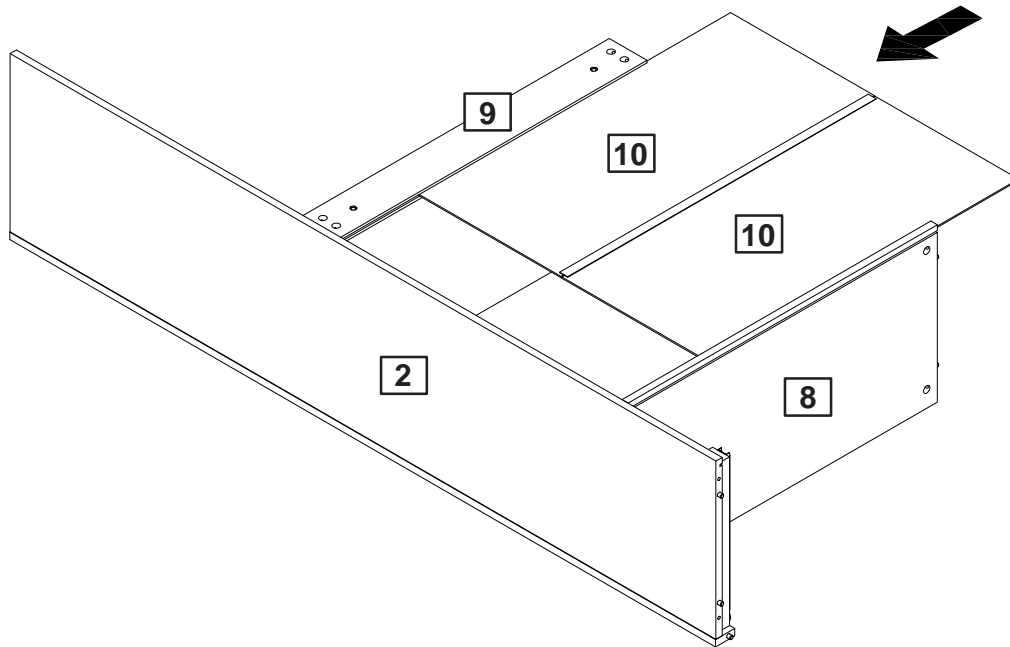

Step 12

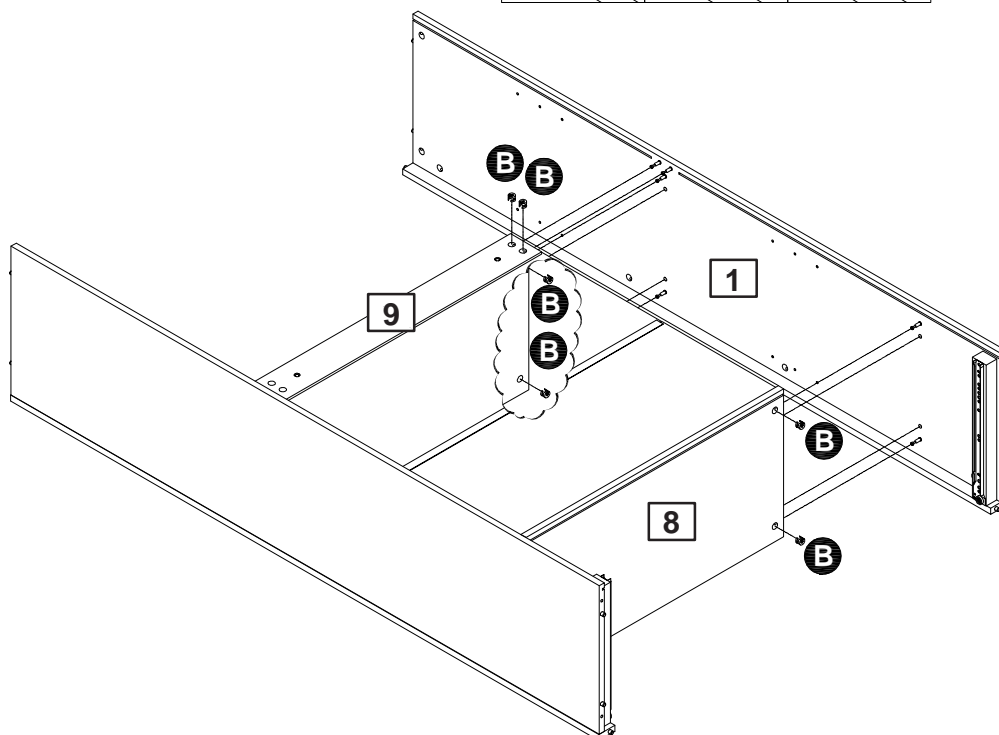
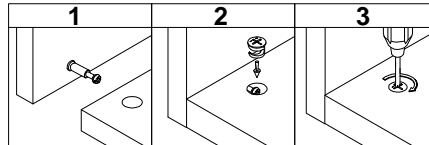

Assembly Instructions

Step 13

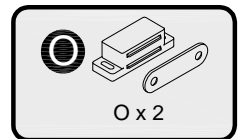
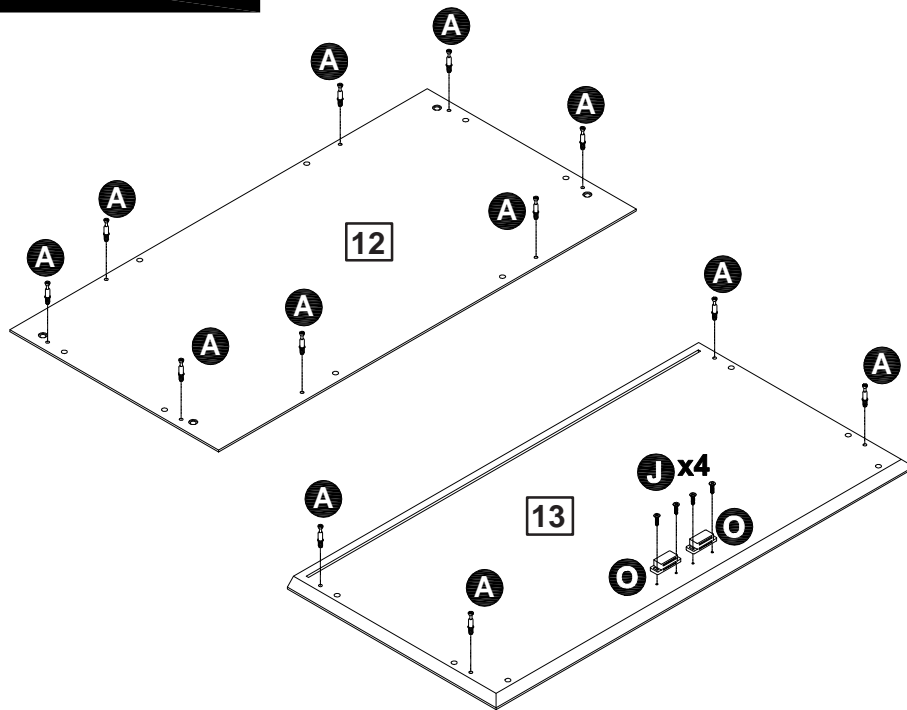

Step 14

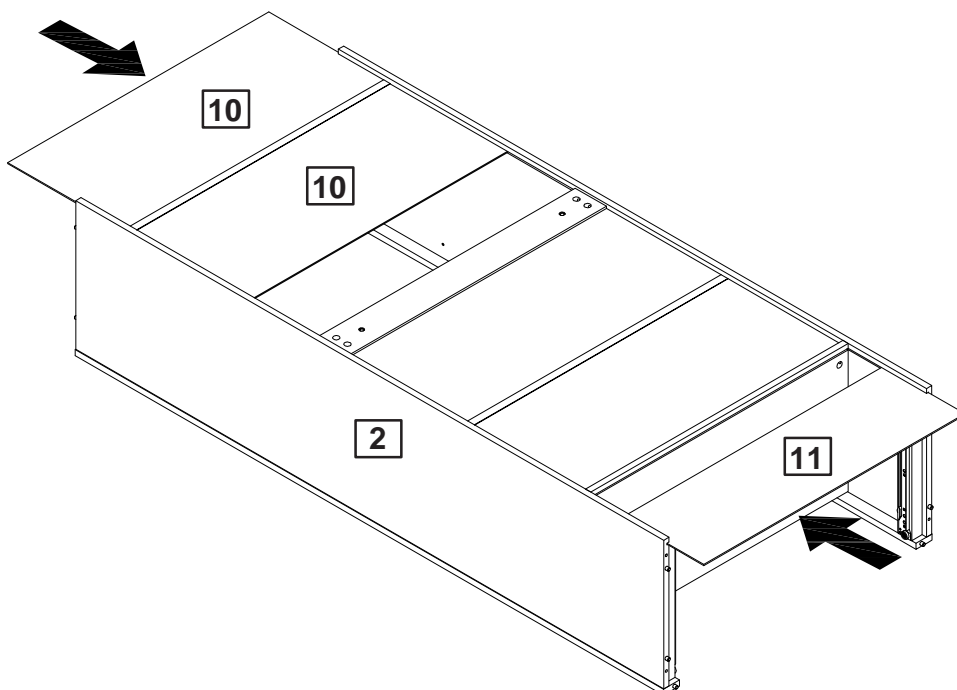

Assembly Instructions

Step 15

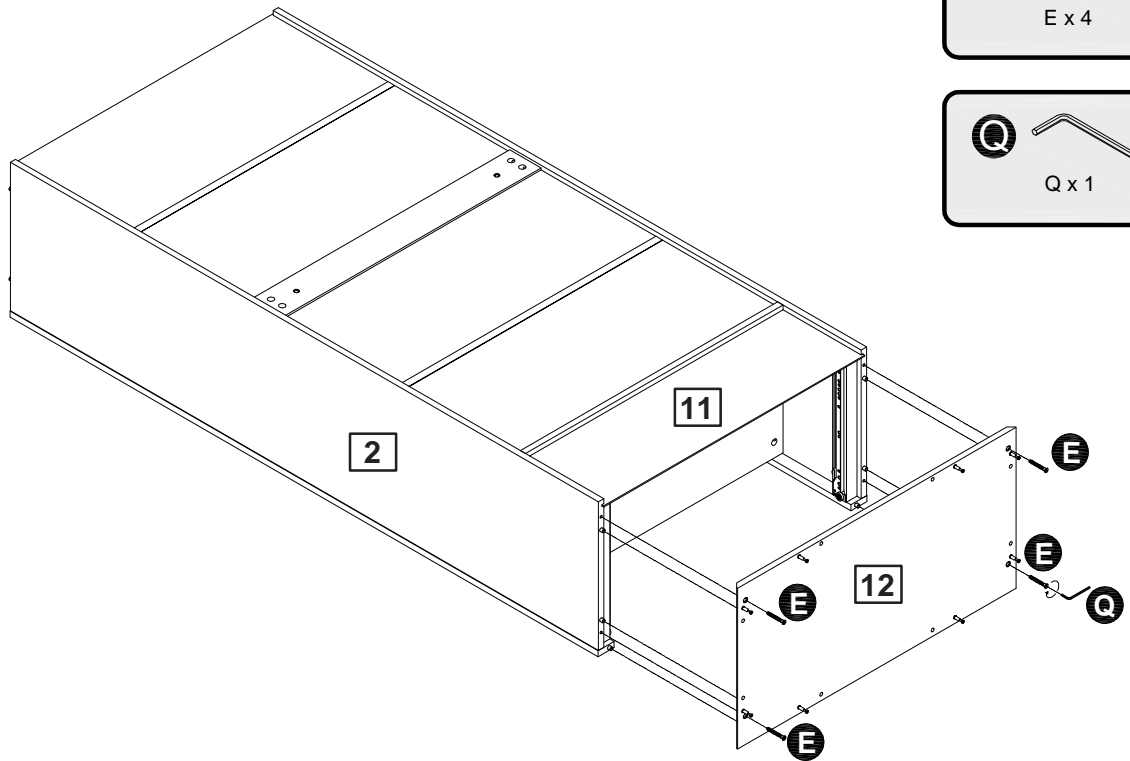

E x 4

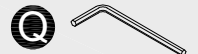

Q x 1

Step 16

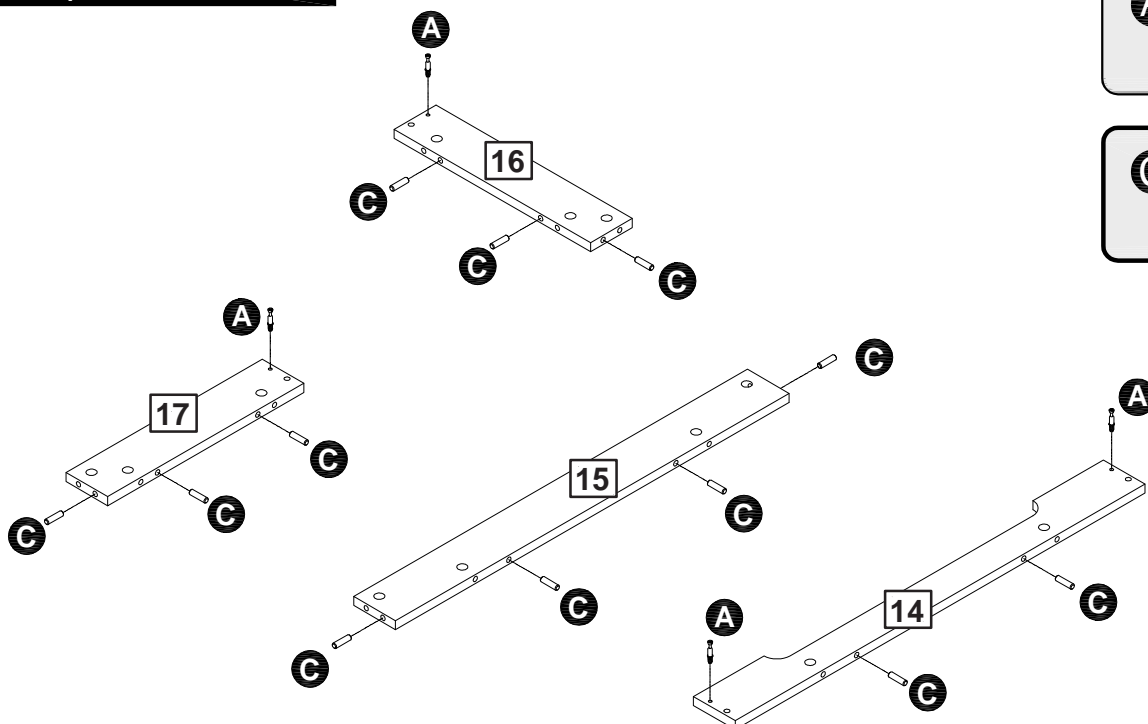

A x 4



C x 12

Assembly Instructions

Step 17

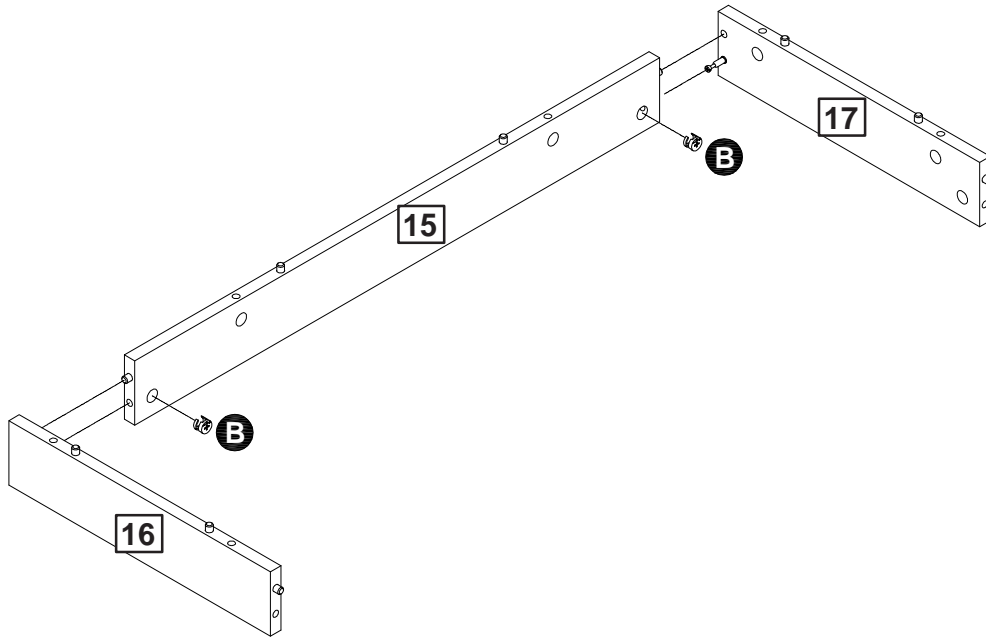
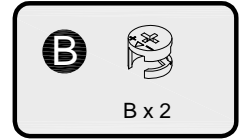
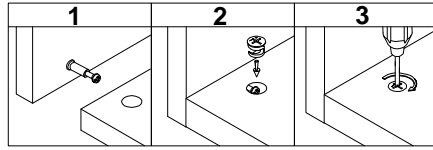

Step 18

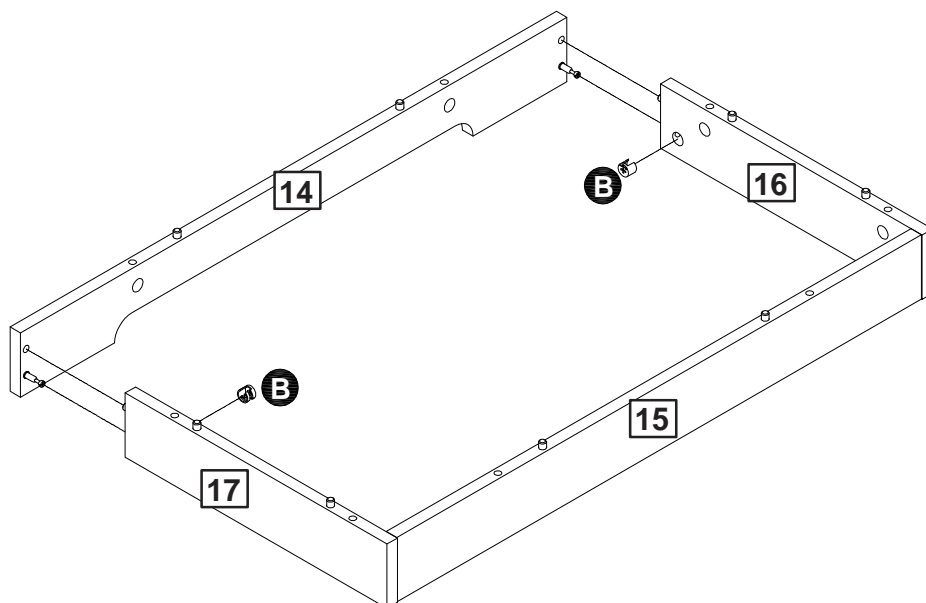
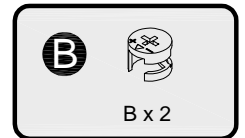
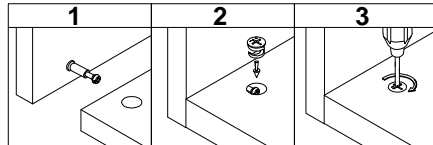

Assembly Instructions

Step 19

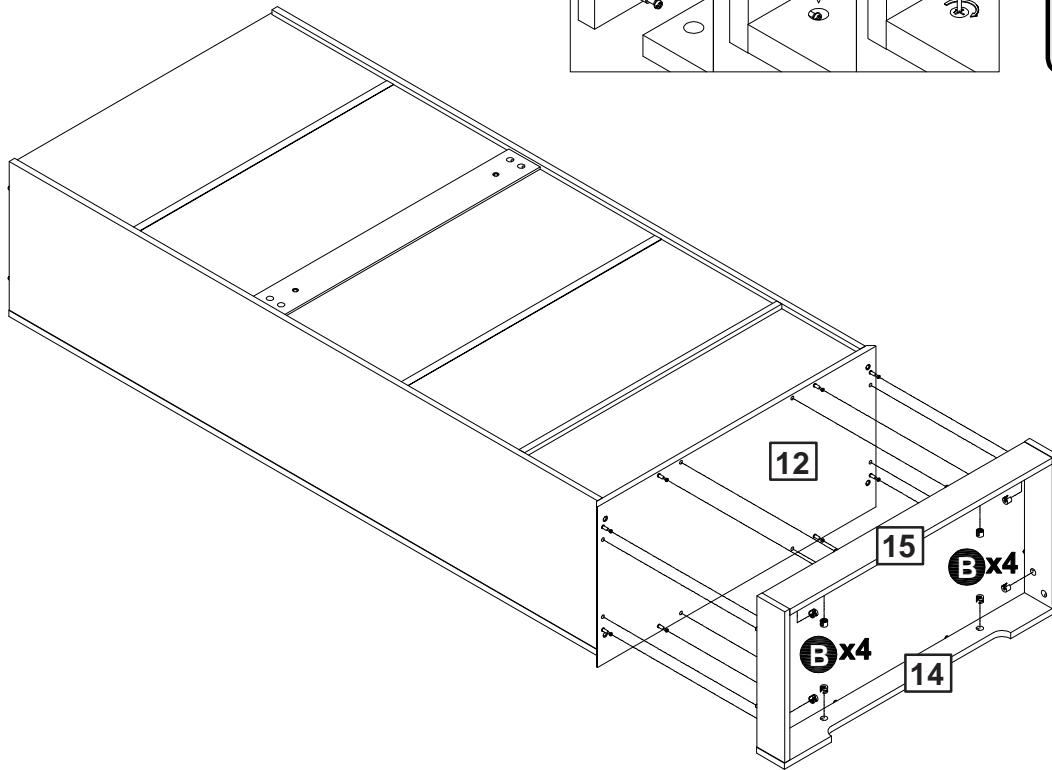
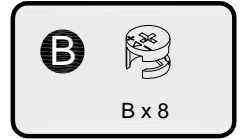
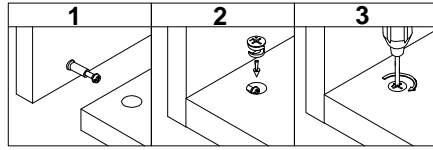

Step 20

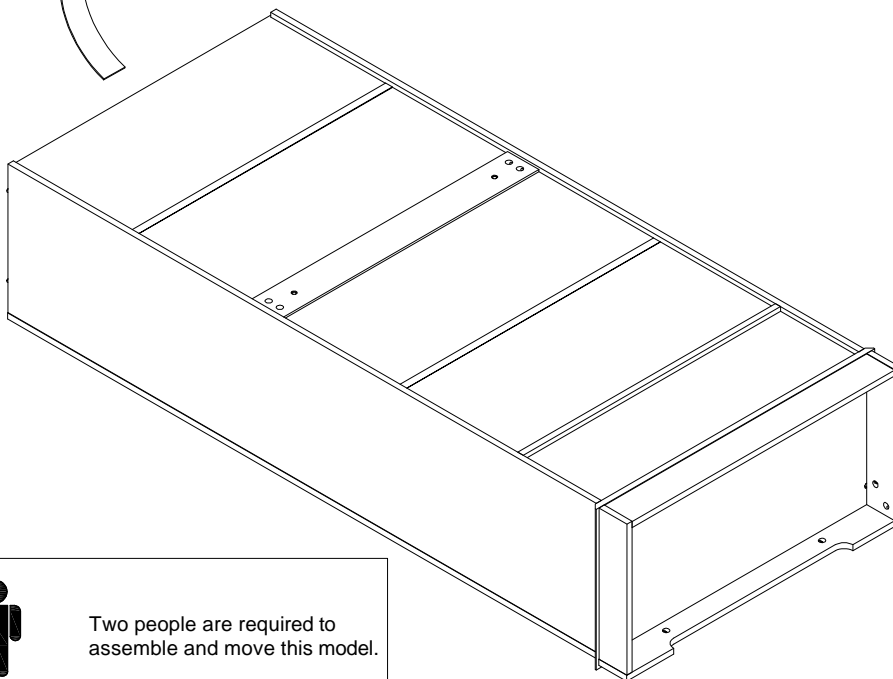

Two people are required to assemble and move this model.

Assembly Instructions

Step 21

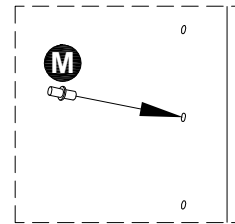
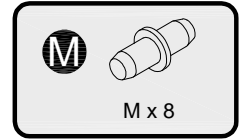
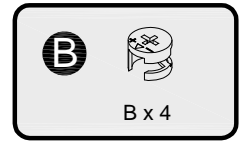
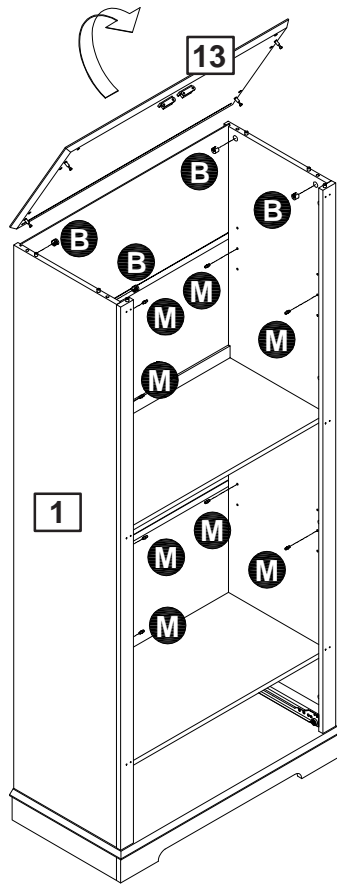
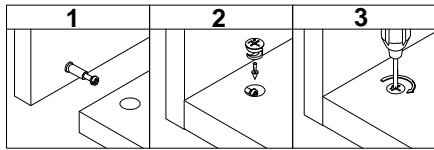

Step 22

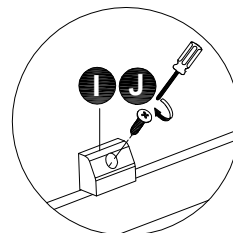
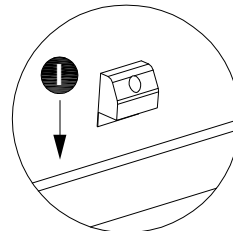
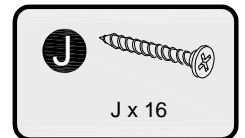
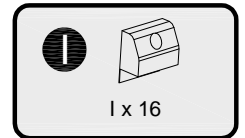
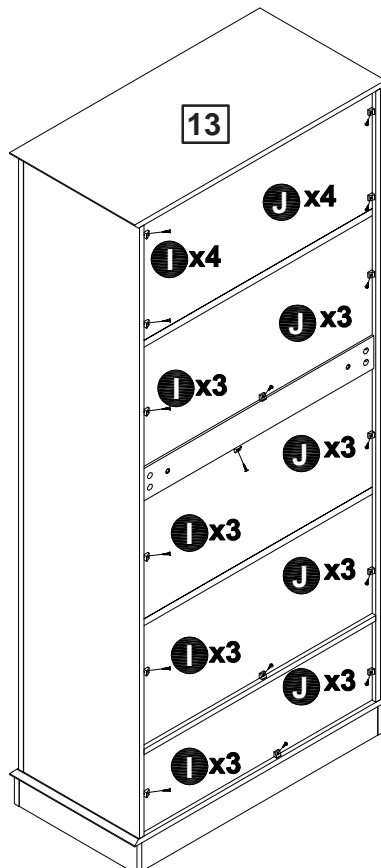

Assembly Instructions

Step 23

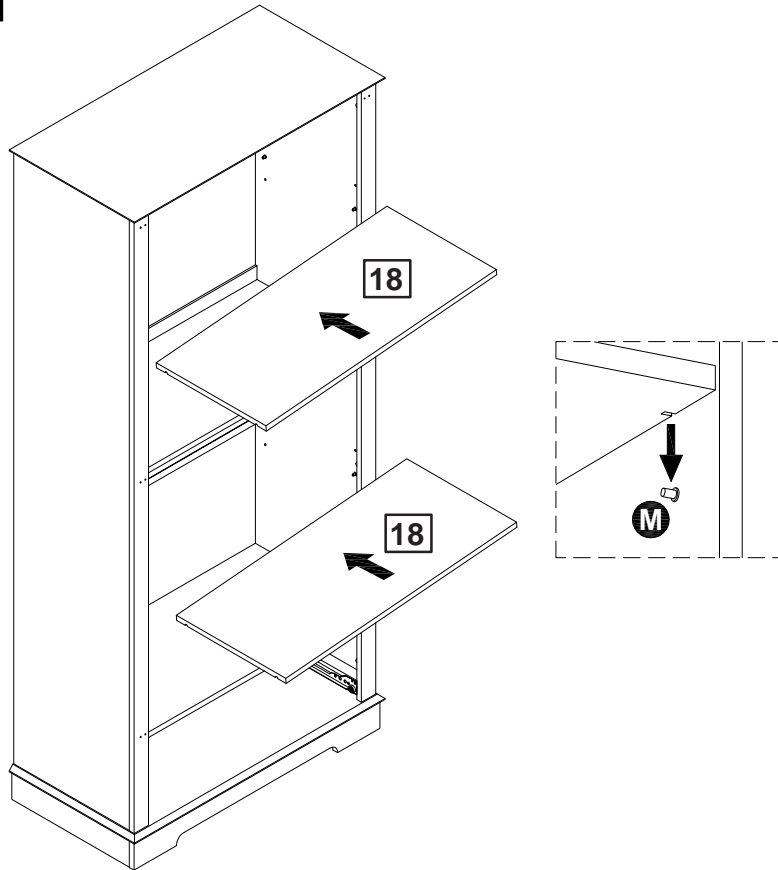

Step 24

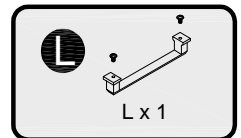
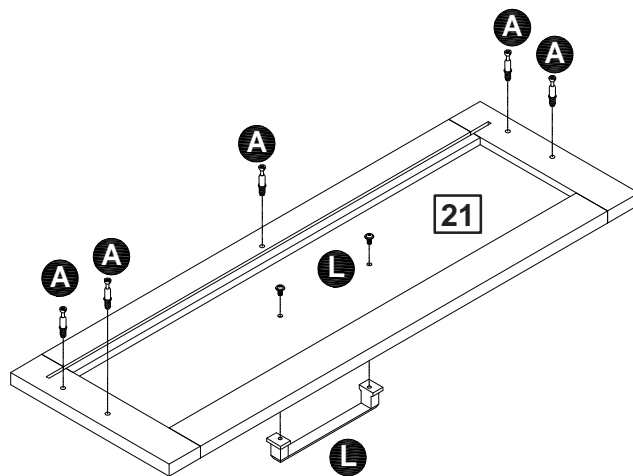

Assembly Instructions

Step 25

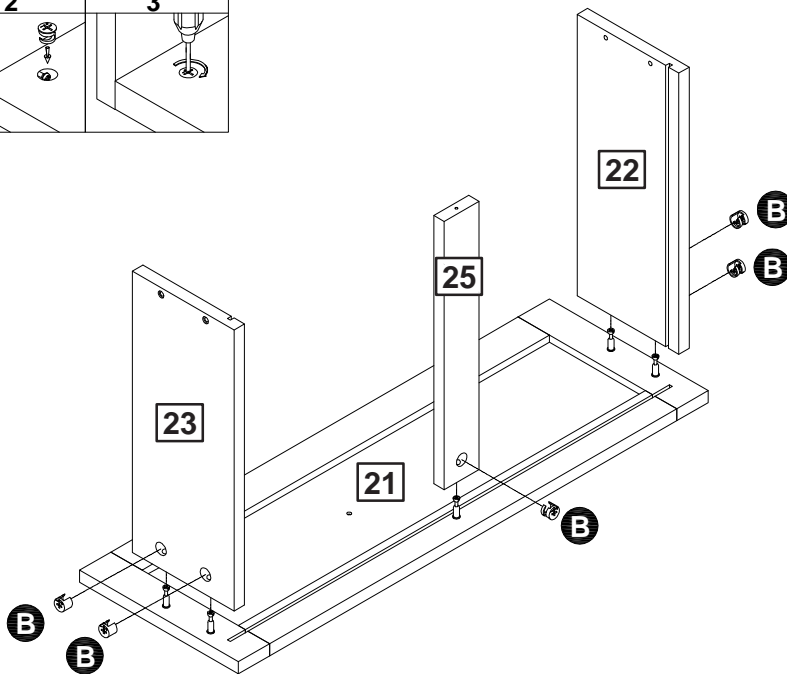
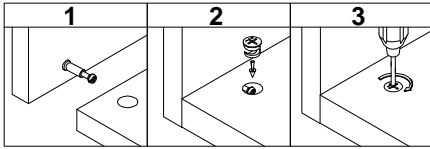
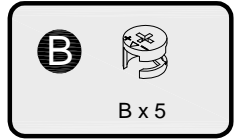

Step 26

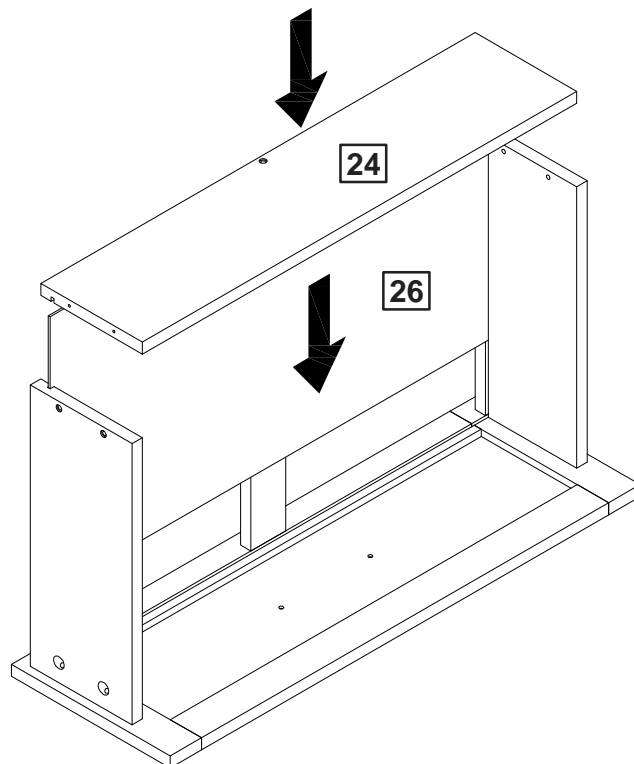

Assembly Instructions

Step 27

P



P x 5

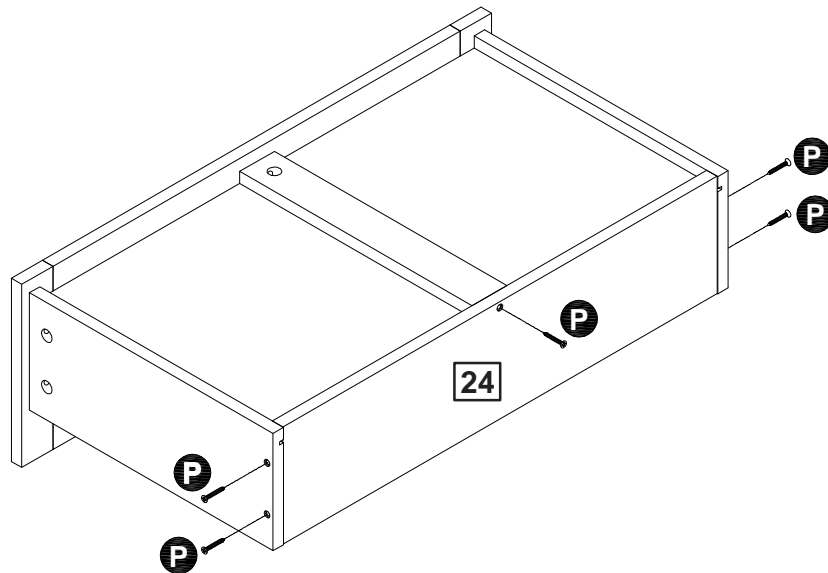

Step 28

D

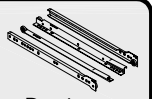

D x 1

H



H x 4

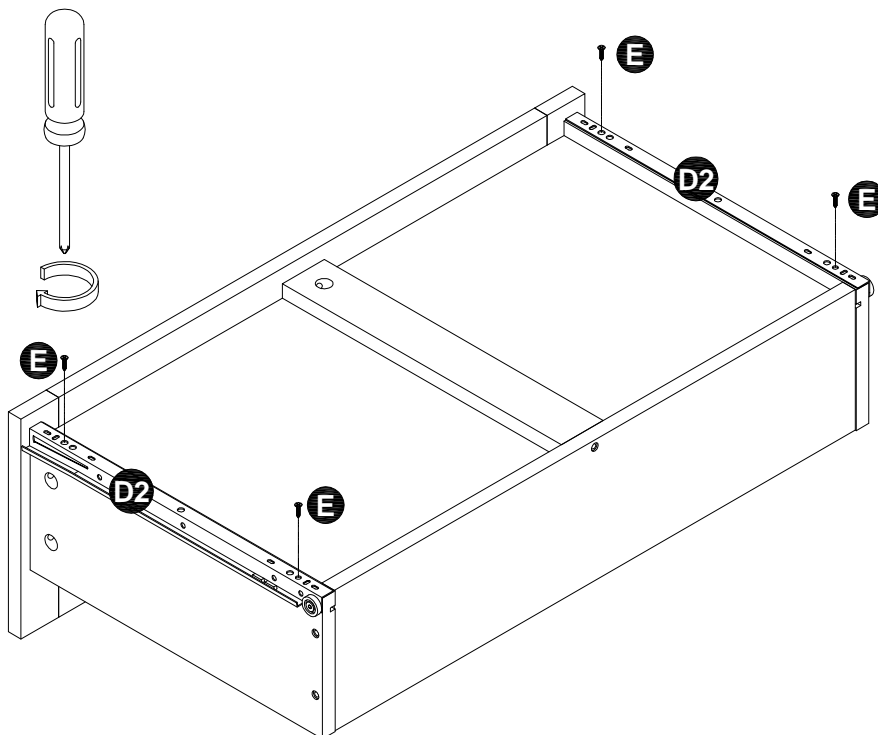

Assembly Instructions

Step 29

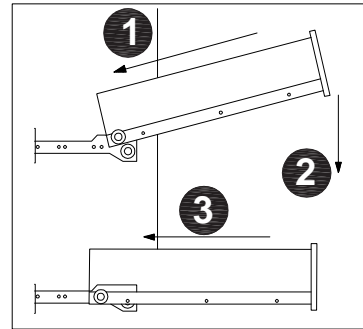
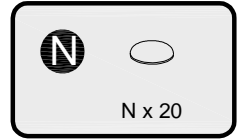
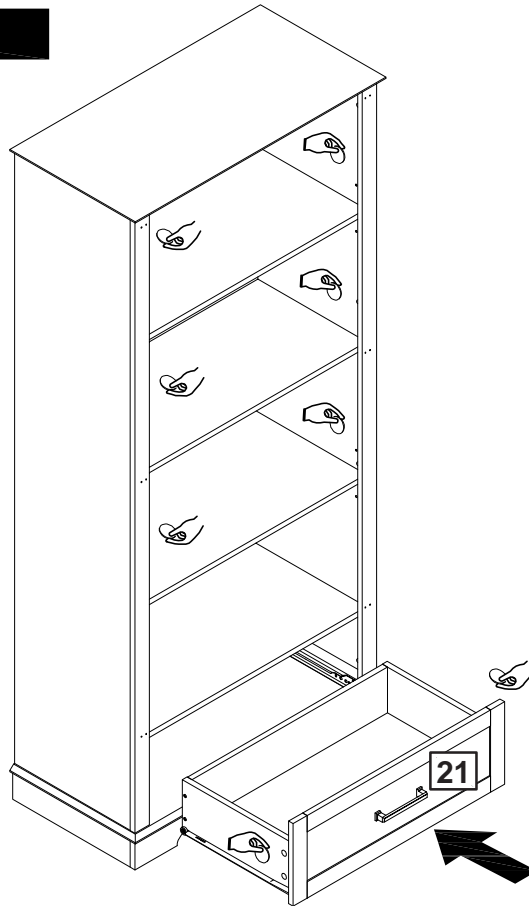
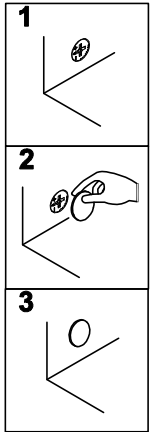

Step 30

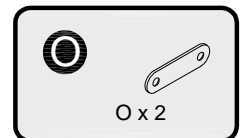
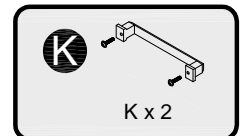
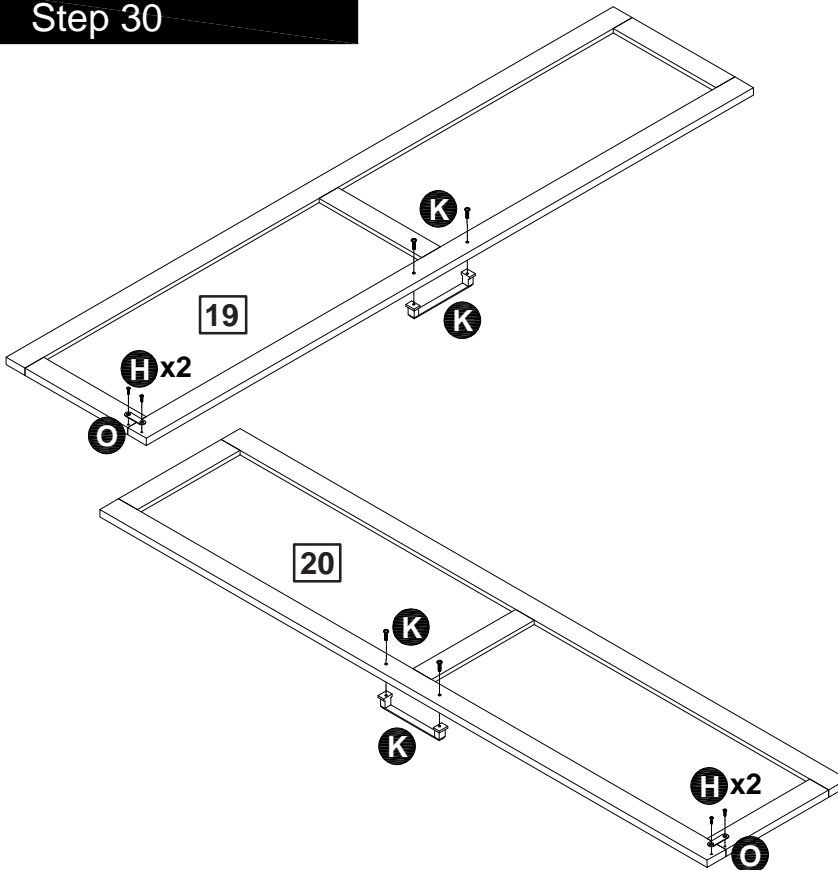

Assembly Instructions

Step 31

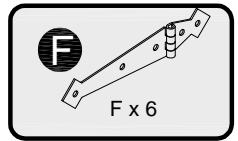
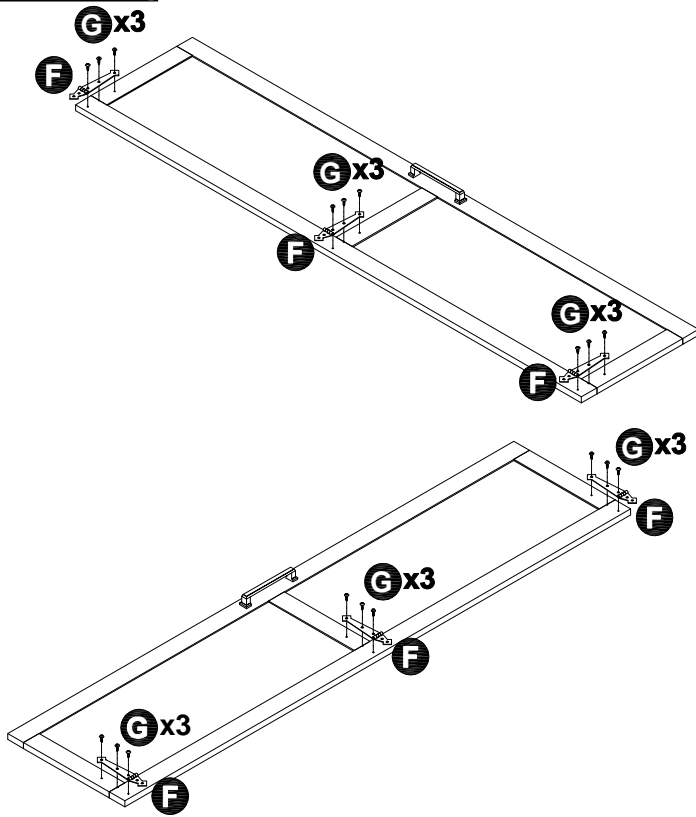

Step 32

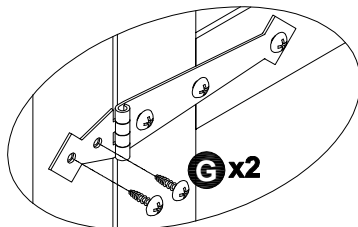
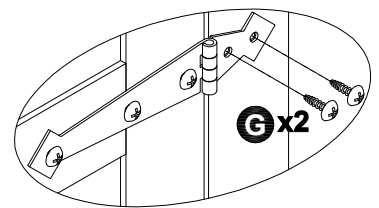
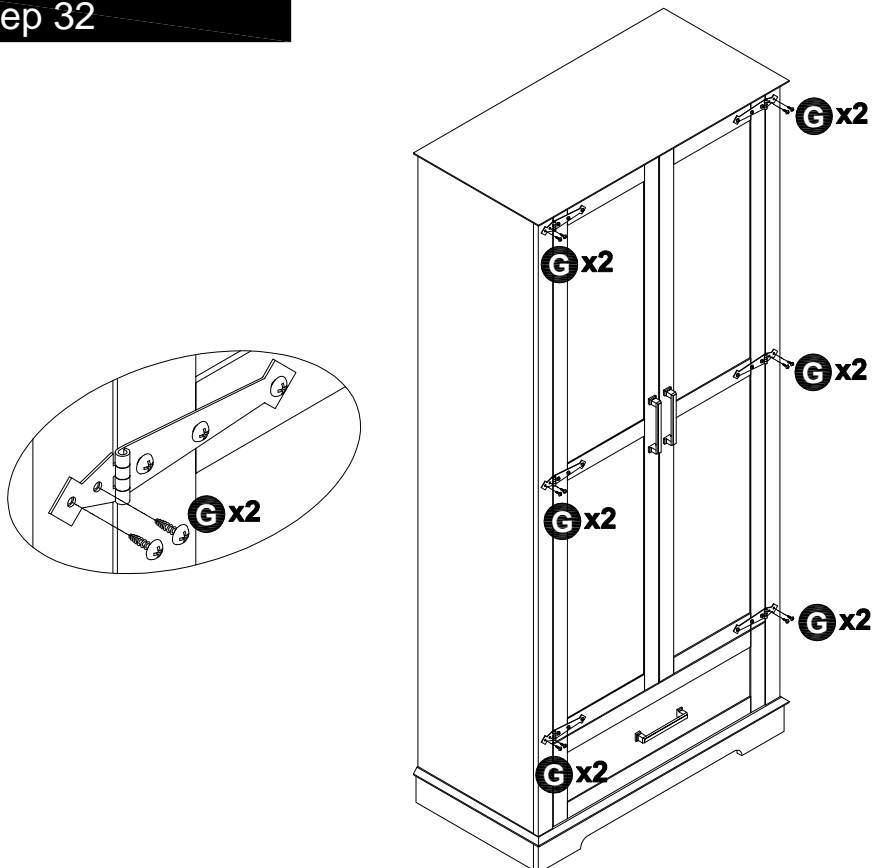

Assembly Instructions

Step 33



DANGER - To prevent furniture from toppling attach, mount, bolt or otherwise secure to walls and floors.
Do not put heavy items on top shelves.
Do not place unstable furniture near where children play.
An anchor kit suitable for plaster walls is included with this item, if you require a different kit consult your nearest hardware store.

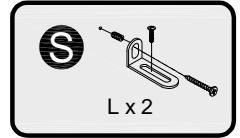

WALL

(1)

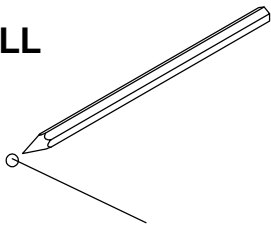

WALL

drilling hole
Ø6x30mm

(2)

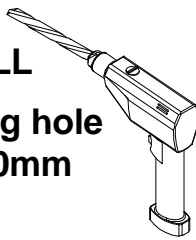

WALL

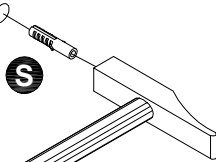

(3)

(4)

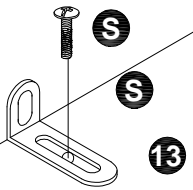

WALL

(5)

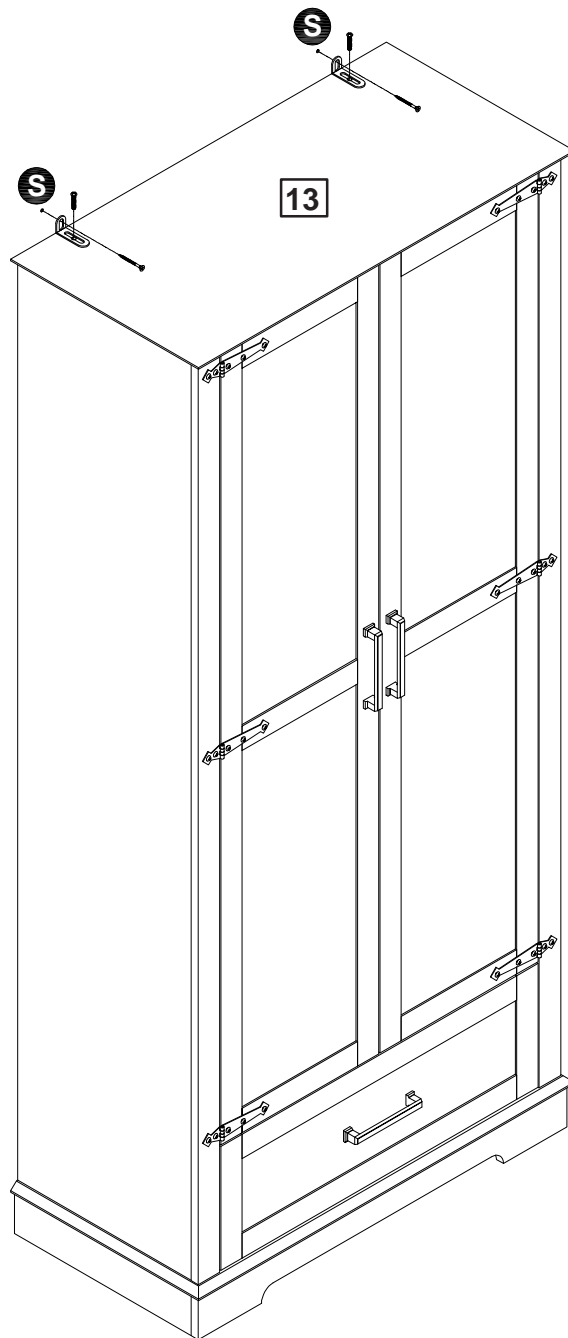
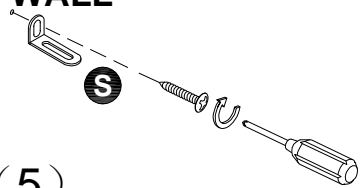

A Guide to Wall Mounting & Fixings

Important note:

If plastic wall plugs (rawl plugs) are supplied with your product, e.g.:



- these are only suitable for use in masonry walls.

If you are in any doubt about the correct wall plugs for your wall, seek professional advice.

Failure of the product due to using the incorrect fixings is the responsibility of the installer.



Important: when drilling into walls always check that there are no hidden wires or pipes etc.

Make sure that the screws and wall plugs being used are suitable for **supporting your unit**. **Consult a qualified tradesperson if you are unsure.**

Hints:

- 1: General rule:  always use a larger screw and wall plug if you are not sure.
- 2: Ensure you use the recommended drill bit to match the wall plug and hole size.
- 3: Ensure you drill the hole horizontally; do not force the drill or enlarge the hole.
- 4: Take extra care when drilling high walls, ceilings and ceramic tiles. Ensure wall plugs are inserted beyond the thickness of the ceramic tiles to avoid the tiles splitting or cracking.
- 5: Ensure wall plugs are well fitted and are a tight fit in the drilled hole.

Types of walls

You can use one of the following types of wall plug if your walls are made of brick, breeze block, concrete, stone or wood.

No.1 "General Purpose" wall plug

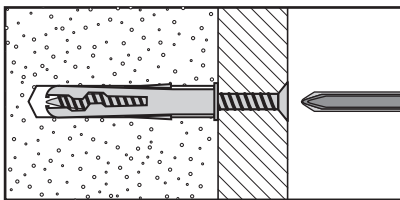

Generally aerated blocks should not be used to support heavy loads, use a specialist fitting in this case. For light loads, general purpose wall plugs can be used.

No.3 "Cavity Fixing" wall plug

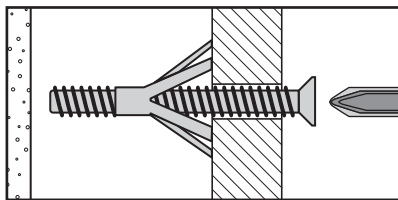

For use with plasterboard partitions or hollow wooden doors.

No.5 "Hammer Fixing" wall plug

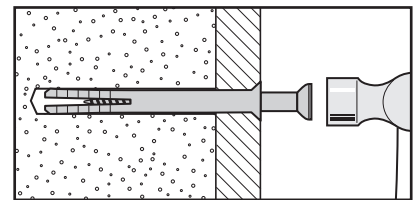

For use with walls stuck with plasterboard. The hammer fixing allows it to be fixed to the wall rather than the plasterboard. Always check the fixing is secure to the retaining wall.

No.2 "Plasterboard" wall plug

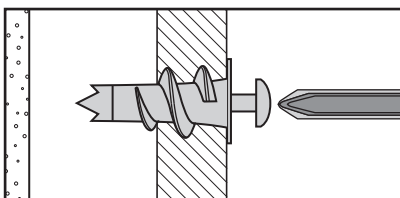

For use when attaching light loads onto plasterboard partitions.

No.4 "Cavity Fixing - Heavy Duty" wall plug

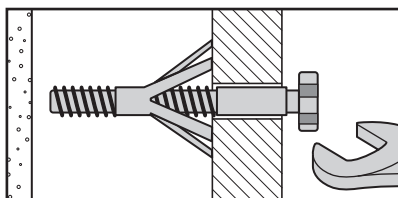

For use when fitting or supporting heavy loads such as shelving, wall cabinets and coat racks.

No.6 "Shield Anchor" wall plug - heavy loads

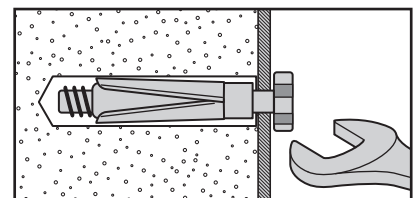

For use with heavier loads such as TV and HiFi speakers and satellite dishes etc.



Care & Maintenance

Safety: always check the fitting and location to ensure your safety in and around the home.

Fitting: from time to time check the fitting to ensure the wall plugs or screws do not become loose.