

Thank you for purchasing your shed. No matter what size garden, a shed is the most practical of garden structures. Simply follow these step by step instructions and our top tips and you'll be enjoying your shed for many years to come. If you have any questions or need advice, our friendly team is here to help.

SHED INSTRUCTIONS

LARGE SHEDS SINGLE DOOR (8x6)

FIXING PACKS CONTAIN:

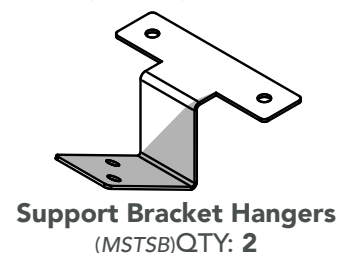
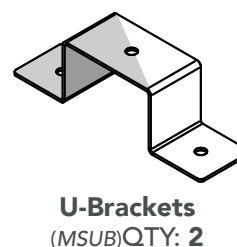
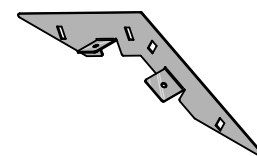
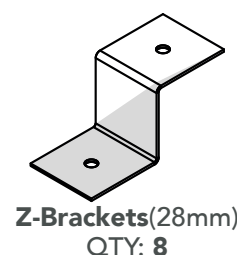
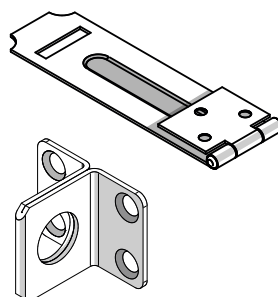
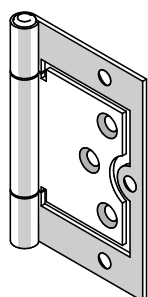
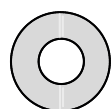
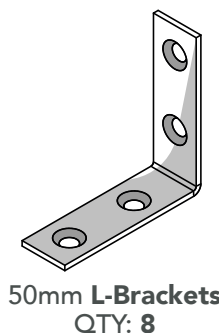
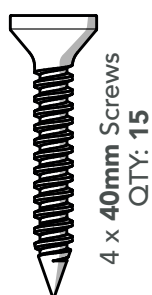

BEFORE YOU START

Please read through these instructions to familiarise yourself with your shed. We recommend that you **check all the components** using the lists found on the front and back pages before you start to build.

All of our sheds are constructed in the same way. They simply come with different components depending on the type of shed you have. Don't worry if your fixing pack contains some spare items at the end of the build (you haven't missed a bit!) we have sent you a generic fixing pack to suit the shed range.

BASE PREPARATION

It's vital that you build your new shed on a **solid, level base**. Timber or Plastic Shed Bases are ideal, as is solid concrete or concrete slabs.

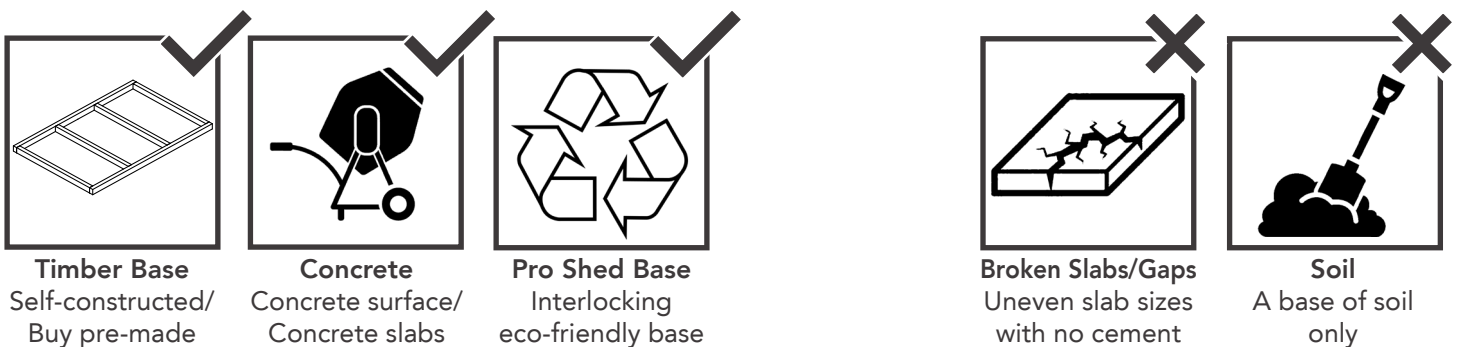

If you have an existing base and think it's suitable for your new shed to be sited on, it is important you check that it is level and doesn't deviate by any more than 15mm from edge to edge. If this isn't the case the building will twist, causing gaps to appear in the sections and the roof, doors and windows to misalign.

TOOLS NEEDED

We recommend using the following tools (not supplied):



Assembly is relatively straightforward if you follow these step by step instructions. We recommend getting everything aligned properly before screwing together and that **screw holes should be pre-drilled** to avoid splitting the timber.



IMPORTANT
Assembly requires 2+ adults.



REMINDER
Always pre-drill before screwing.

PLEASE KEEP PLASTIC BAGS AND SMALL PARTS AWAY FROM CHILDREN

To help you get the most out of our products it's useful to know a little more about the properties of timber, what's normal and how your shed may behave as the seasons change. Wood is an extremely durable material for construction but as a natural product when used outdoors it is susceptible to changes in the environment.

THINGS THAT YOU MIGHT SEE IN YOUR PRODUCT



MOVEMENT, TWISTING & WARPING

Wood contains a natural level of moisture so decreasing humidity levels in the surrounding air may cause panels to change their shape as the porous fibres shrink. This can be exaggerated during prolonged periods of dry weather. Movement and gaps in timber products are normal, in most cases the wood will revert to its original form once the high temperatures subside and there is more moisture content in the air. Similarly, in the winter months, the opposite may occur with wood swelling.



EXPANSION, CONTRACTION, SPLITS & CRACKS

All timber will expand and contract according to its environment. As a result of this expansion and contraction, it is very common to see splits and cracks developing in the wood. Splits are common during the spring and summer months as the wood begins to dry out. The outer surface dries first and contracts, contracting over a still expanded core of the wood. The result of this is that splits and cracks appear along the grain of wood. These splits are not a fault and do not affect the structural integrity of a product.



MOULD & BLUE STAIN

Mould is a surface-dwelling fungus that feeds on the nutrients and debris contained in the surface cells of timber. The most common problems associated with mould are discoloured timber and an increase in permeability of the timber. Blue stain is part of the same family but penetrates deeper into the surface layers of the timber. It stains the timber a dark blue, whereas mould is usually black. These do not cause the timber to rot. Keep the building well ventilated to avoid mould.

ADVICE ON FELT HANDLING & USAGE

Roofing felt is flexible at temperatures above 5°C. In cold temperatures extra care must be taken when handling and installing to prevent cracking and damage to the felt. The felt should not be rolled, folded or used in temperatures lower than 5° C. In cold temperatures the felt should be stored above 10°C (indoors) for 24 hours prior to use. Felt must be lifted, not dragged and should be stored on its end on a dry surface.

THE ROOF OF THIS BUILDING IS NOT A LOAD BEARING STRUCTURE

8 TOP TIPS TO ENSURE YOUR SHED IS FULLY WATERPROOF

- 1 MAKE SURE YOU POSITION YOUR SHED IN THE BEST LOCATION IN YOUR GARDEN**
Avoid areas where water pools and is constantly wet. Position away from trees and cut back any overhanging foliage which can cause moisture to be trapped against shed walls and debris to collect on the roof.
- 2 RAISE YOUR SHED OFF THE GROUND**
Ideally any concrete base should be the same footprint as the shed to allow surface water to run off without pooling, a timber shed base can also be used. Raise 50mm above ground level.
- 3 SEAL THE BASE**
We recommend a treatment containing wax or oil, paint the bearers that come into contact with the ground to prevent moisture coming up.
- 4 USE AN END-GRAIN PROTECTOR**
To protect the corners and panel joints, an end grain treatment can be applied.
- 5 SEAL THE PANELS & WINDOWS**
Use a flexible silicone sealant around windows to prevent water ingress. This can also be used where 2 sections of the shed joint together. Apply internally.
- 6 CONSIDER ADDING GUTTERS**
Adding guttering around the fascia of the shed will redirect rain water away from the shed's foundation.
- 7 KEEP VENTILATED**
Good airflow around the perimeter of the shed and regular ventilation inside the shed will help prevent mould and mildew.
- 8 CONSIDER A WEATHERPROOFING STAIN OR CLEAR TREATMENT**
We recommend you paint your garden shed with a weatherproofing treatment at least once a year. This will help maintain the wood, stabilise timber movement and help prolong the life of your shed.



TREATED TIMBER CONTAINING A BIOCIDAL PRODUCT CONTROL OF WOOD DESTROYING ORGANISMS

Active Ingredients - Propiconazole, Tebuconazole, IPBC, Permethrine, Benzalkonium chloride. (Dip Treated Sheds)
Basic Copper Carbonate, DDA Carbonate, DDA Chloride (Pressure Treated Sheds)

Wear gloves when handling. Avoid inhalation of sawdust. Do not use in contact with drinking water or food. Do not use for animal bedding or in fish ponds. Dispose of treated wood responsibly.

IDENTIFY YOUR SHED

From the **section layout** below, identify your shed based on the **width** and **depth** dimensions of your shed – eg 8x6. You'll need this to identify the side panel positions.

KEY

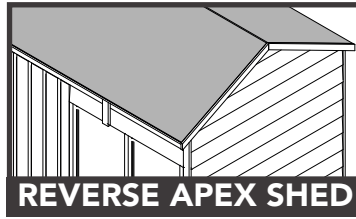
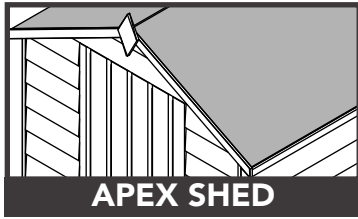

A 1ft Panel (295 x 1603mm)

D 3ft Panel (885 x 1603mm)
(With & without windows)

B 1.5ft Panel (442 x 1603mm)

E 4ft Panel (1180 x 1603mm)
(With & without windows)

C 2ft Panel (590 x 1603mm)
(With & without windows)

PLEASE NOTE

The sheds are made up of multiple sections where same size panels are interchangeable.

The door is flexible for all shed types and can be hinged onto either side.

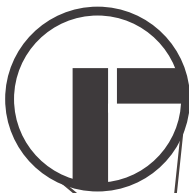
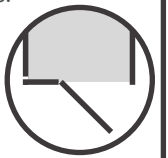

Indicates the panel orientation during construction. This will apply to all of the corners for your chosen shed.

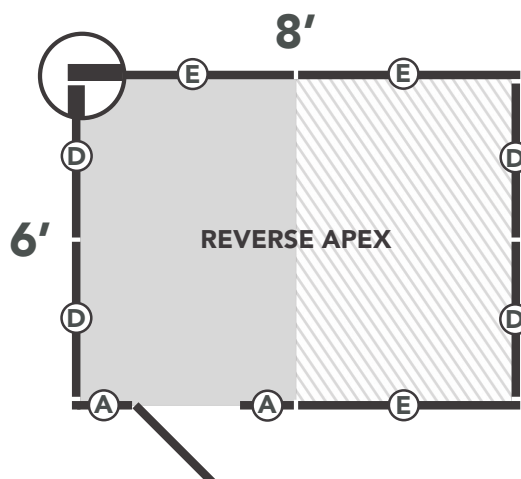
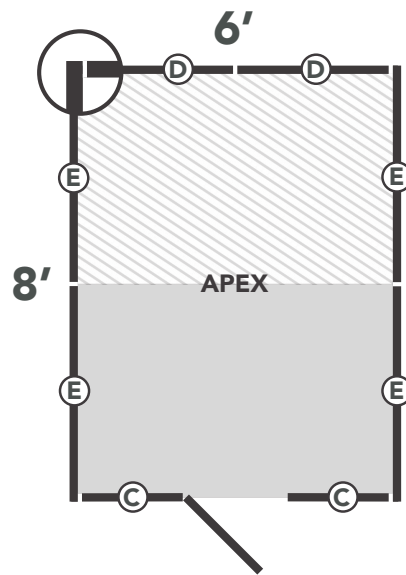
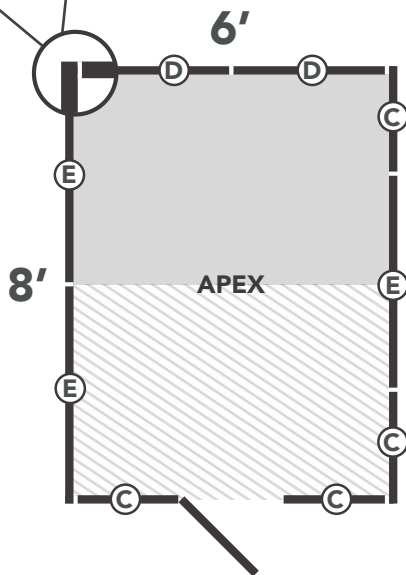

1 CONSTRUCTION

1a FLOORS & SIDES



Position the floor in your desired location. Turn the floors upside down to secure the sections together by screwing through the adjoining bearers. Layout the panels around your shed base.

We recommend to start in a back corner then work from the back panels to the front panels for assembly.

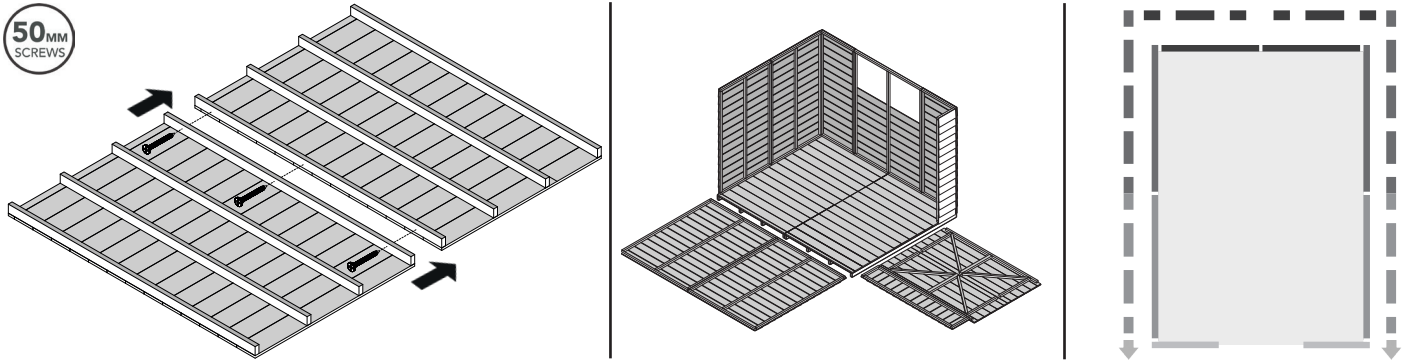

1b Start at a back corner. See the section layout on page 4 to confirm position. Secure the corner as shown below.

Repeat the process for remaining panels and secure panels together. Make sure that the bottom frame of the wall panel rests on the outer edge of the floor.

Secure the panels into place by screwing into the floor. Screw the door batten down.

EG. INSIDE CORNER

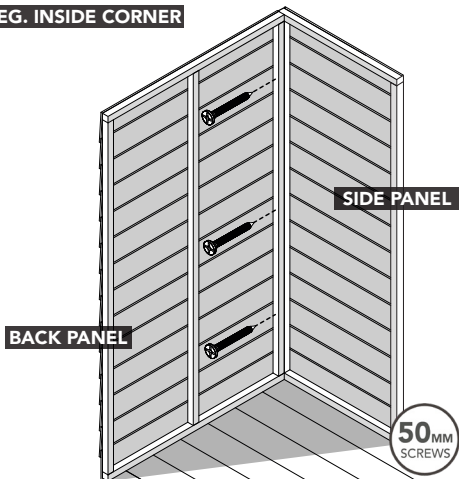

EG. SIDES



EG. INTO FLOOR

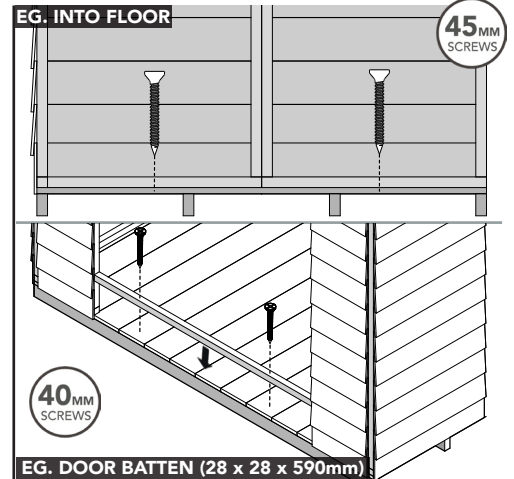

1c Start with the Apex section and work around, screwing the additional panels. Finish with the other Apex section.

Attach the Apex section by screwing to the wall panel and repeat for the other Apex section.

REVERSE APEX ROOF

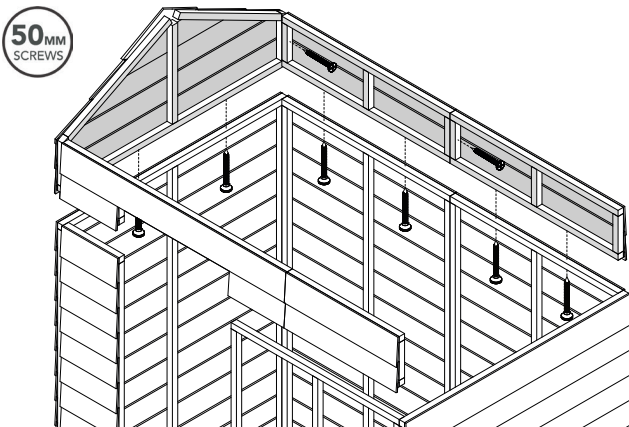

APEX ROOF

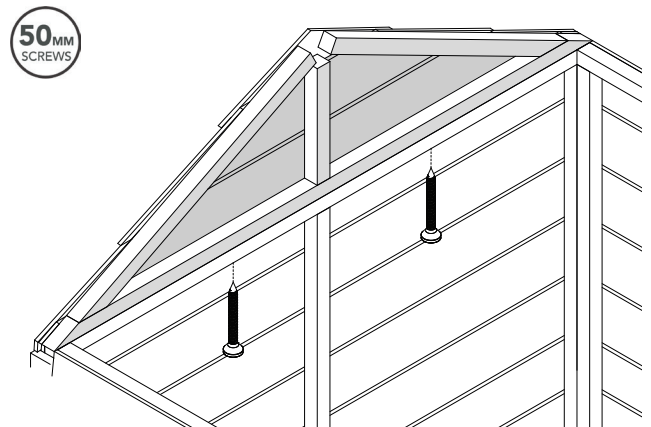

2 WINDOWS

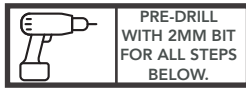

Fix interior sills at the base of windows with L-brackets and screws at a 1002mm distance from the floor. Repeat this for multiple windows, as shown below.

Secure windows by screwing through the window cover strips and window into the panel frame. Screw into the bottom of the window and into the interior sill to keep secure. Make sure the window is centralised for all window frames as shown below.

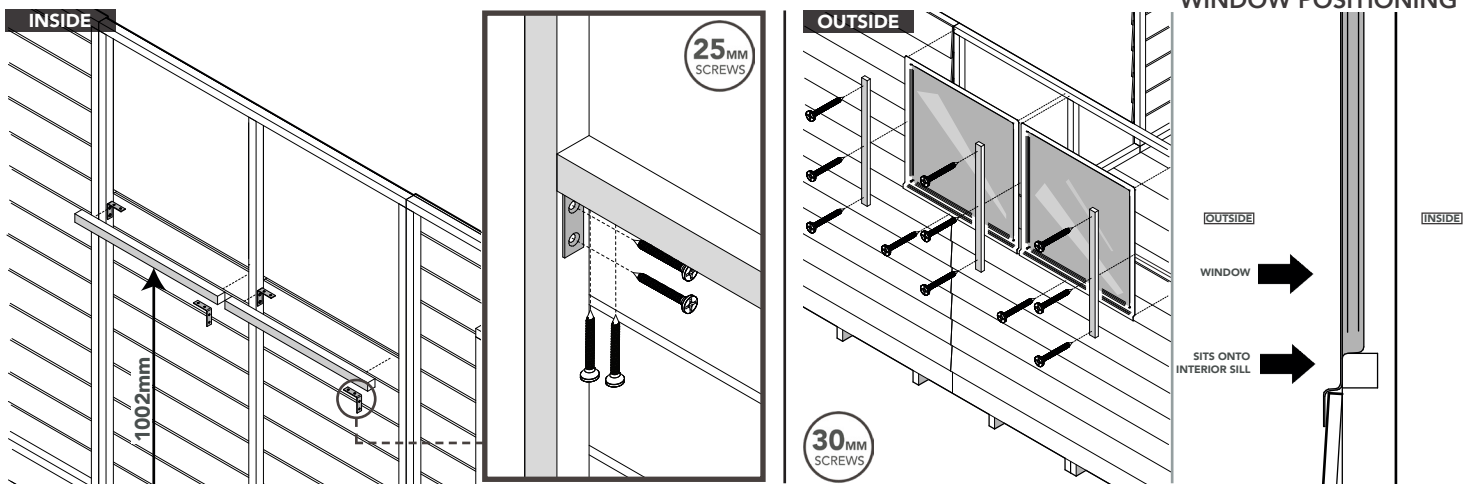

3 COVER AND DOOR STRIPS



Attach the cover strips onto the corners. Ensuring they are flush to the bottom edge of the panels as shown below.

Attach the cover strips onto the adjoining panels. Ensuring it is flush to the bottom edge of the panels as shown below.

Secure the door weather strip onto the side you want the hinges, and ensure it's flush to the floor and against the face of the wall panel framing.

Attach the slamming strip onto the opposite side you want the hinges, onto the wall panel shown below.

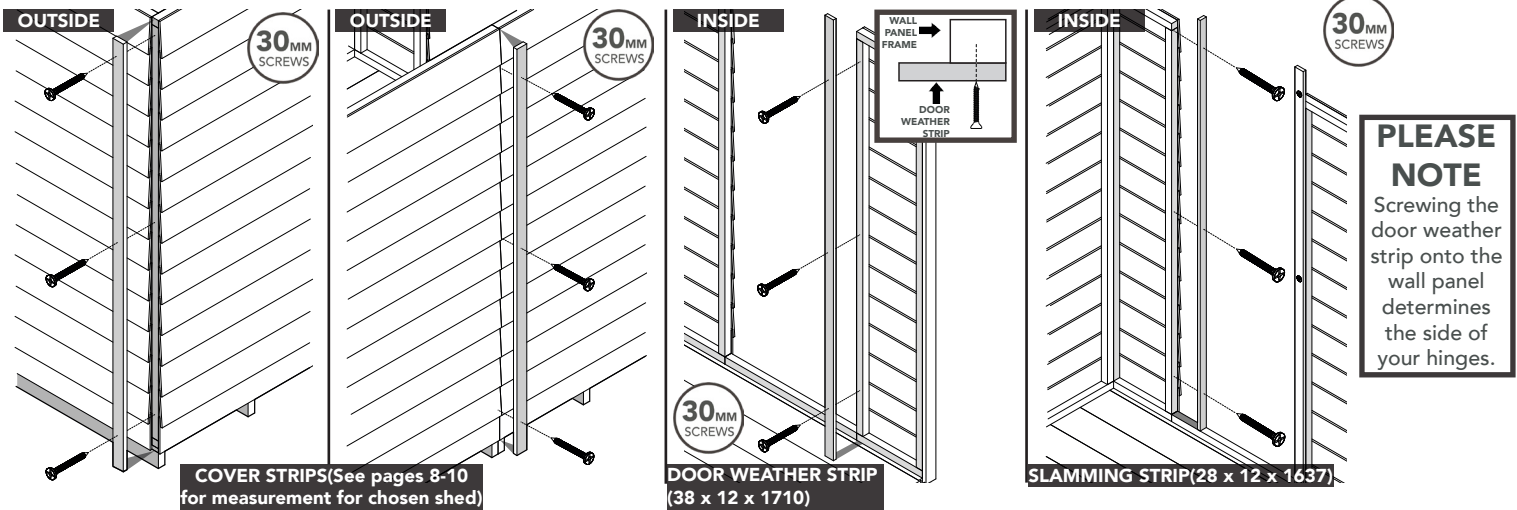

4 DOOR FIXINGS



Attach 2 hinges onto the door frame with the measurements provided. Please take note of the hinge position shown below.

Place the door into the opening, ensuring it's level. Make sure the hinges are up against the door weather strip face.

Fix the Hasp and Staple as shown. Ensure the screws go into the framework behind.

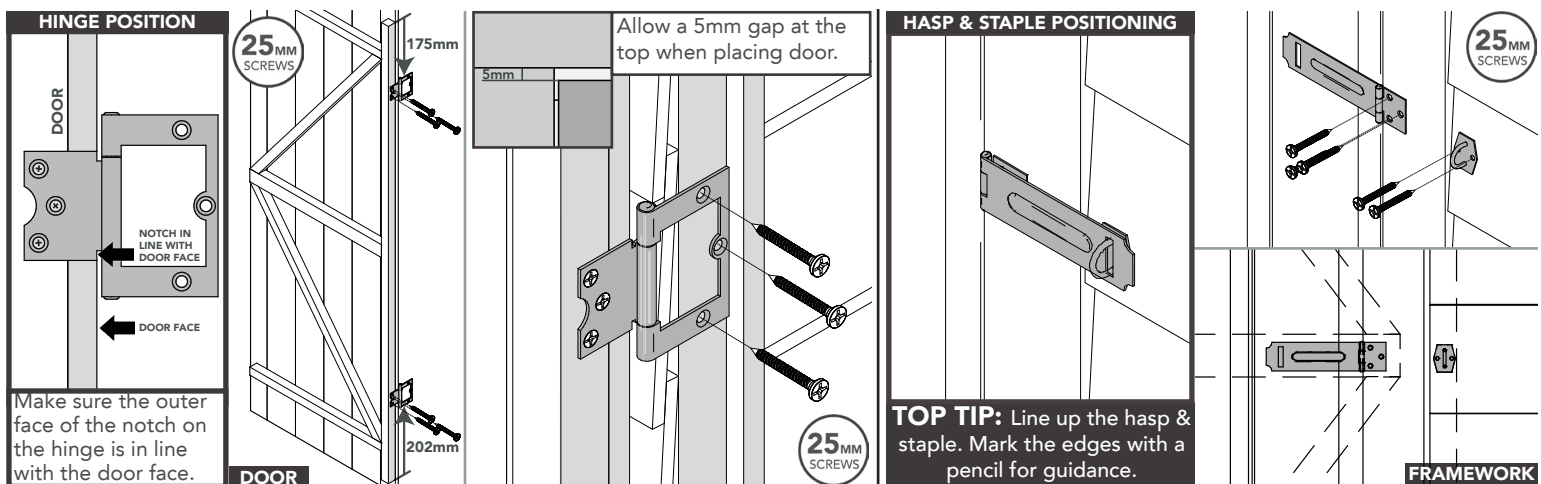

5 ROOF

PRE-DRILL WITH 2MM BIT FOR ALL STEPS BELOW.

5a

Assemble the truss and screw the U-brackets into the center of each beam as shown below. Ensure the truss support brackets are added first and flush to the edge of the central beams to establish the correct angle.

Secure the support bracket hanger with screws into the center of your shed. The measurements provided are from the internal timber on the Apex section. There needs to be one at each side.

Screw the truss to the support bracket hangers. As a result the truss will be centralised inside your shed and facing the Apex sections.

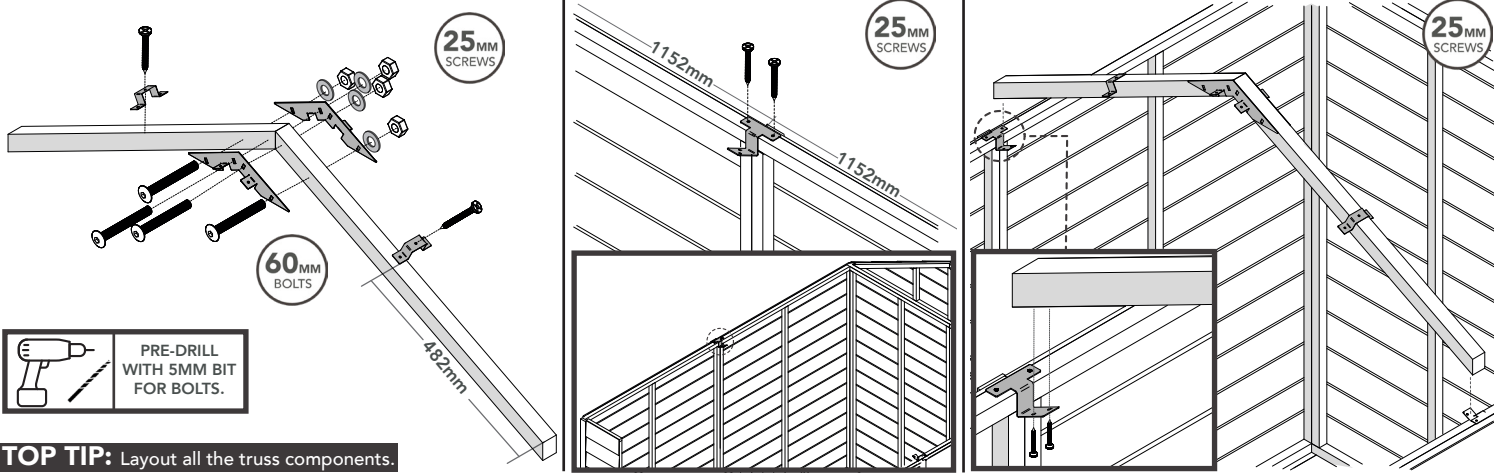

5b

PREPARATION: Attach the Z-brackets onto the face of one end of each beam as shown below. The beam should be flush to the Z-bracket.

ATTACHMENT: Secure the other end of the beams to the U-brackets on the truss by screwing from the underside of the beam.

Screw the Z-brackets that are already attached to beams onto the apex section frame.

Before placing the OSB roof sheets onto the roof, screw the roof support strips along the edge of the OSB roof sheets. Ensuring they are flush to the edges. Add one strip onto each sheet as shown below. The strip will be the same length as one side of the sheet.

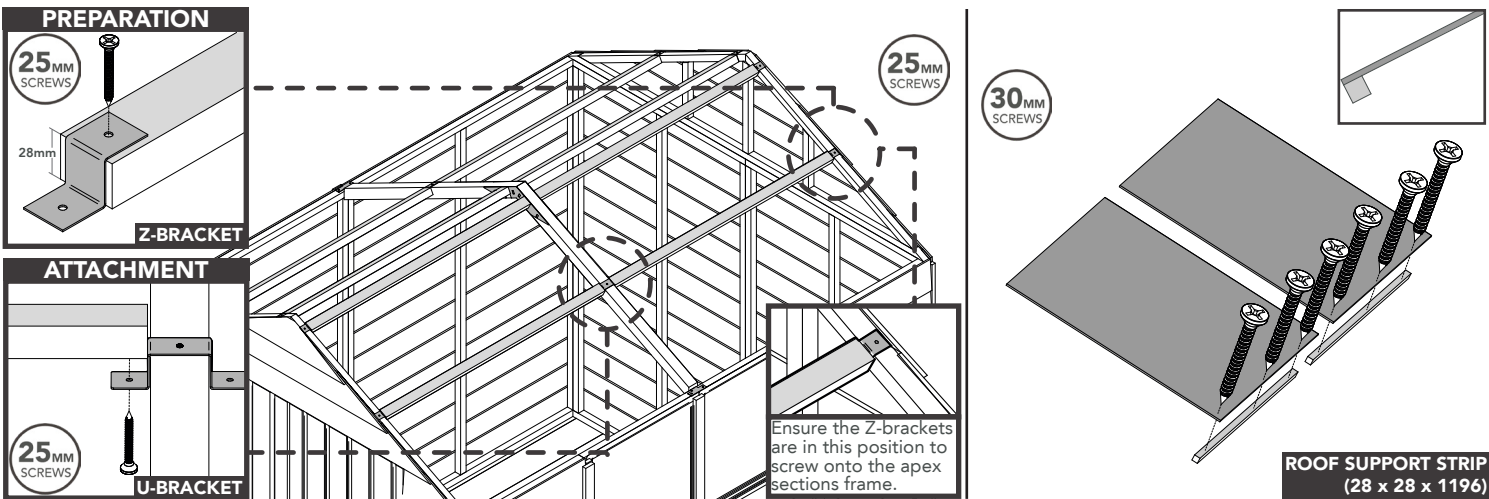

5c

Screw the OSB roof sheets into position as shown below into the shed frame and truss.

Measure out 3 equal lengths and overlap it on the top, around the edges and fold the corners; tack to keep secure. Ensure 50mm at the bottom and work from the bottom to the top.

Secure the fascias and the finial (apex only) with screws as shown below based on your chosen shed.

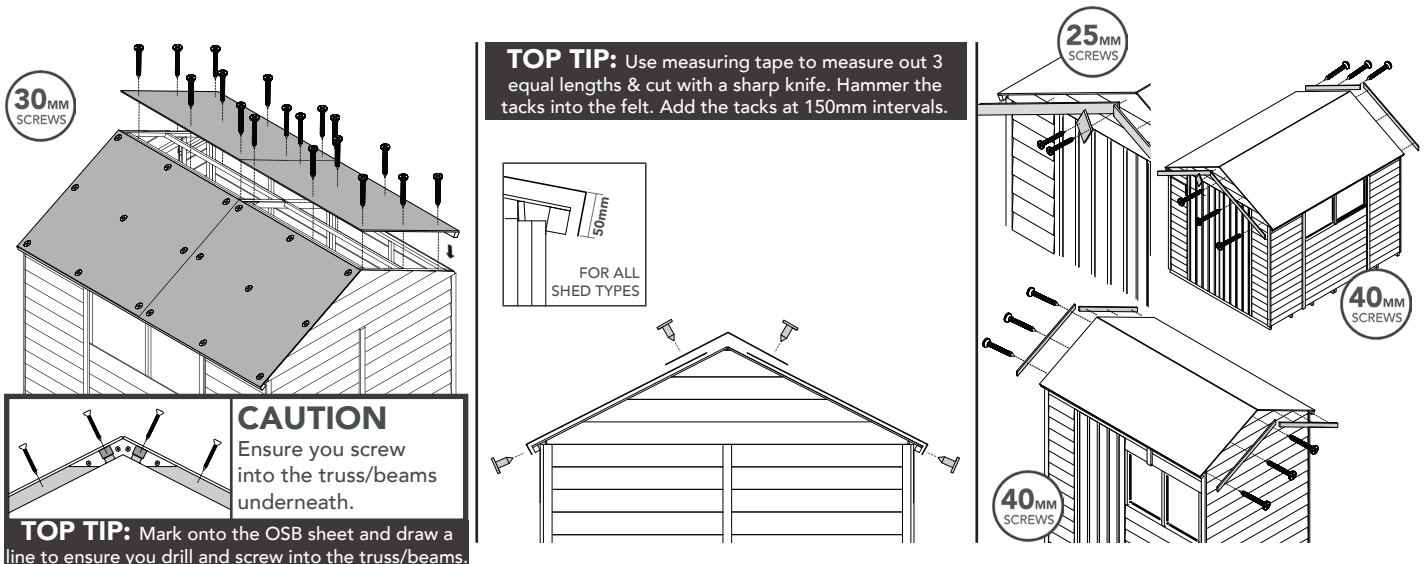

DIP TREATED APEX SHEDS

SELECT YOUR CHOSEN SHED & CHECK YOU HAVE ALL YOUR PARTS.

Overlap Apex 8' x 6' - 2 Windows (ODA65M)			Overlap Apex 8' x 6' - No Windows (ODA68NM)			Overlap Apex 8' x 6' - 2 Windows (ODA682WM)			Overlap Apex 8' x 6' - 4 Windows (ODA684WMF)		
Part Code	Description	No.	Part Code	Description	No.	Part Code	Description	No.	Part Code	Description	No.
ODM85PPP	Section D - 3ft Panel (885 x 1603mm)	2	ODM85PPP	Section D - 3ft Panel (885 x 1603mm)	2	ODM85PPP	Section D - 3ft Panel (885 x 1603mm)	2	ODM85PPP	Section D - 3ft Panel (885 x 1603mm)	2
ODM50PPP	Section C - 2ft Panel (590 x 1603mm)	4	ODM50PPP	Section C - 2ft Panel (590 x 1603mm)	2	ODM50PPP	Section C - 2ft Panel (590 x 1603mm)	2	ODM50PPP	Section C - 2ft Panel (590 x 1603mm)	2
ODM1180WP	Section E - 4ft Window Panel (1180x1603mm)	1	ODM1180WP	Section E - 4ft Panel (1180x1603mm)	4	ODM1180WP	Section E - 4ft Window Panel (1180x1603mm)	1	ODM1180WP	Section E - 4ft Window Panel (1180x1603mm)	2
ODM1160PP	Section E - 4ft Panel (1180x1603mm)	2	ODAMPEA6	Apex Section - Back	1	ODM1160PP	Section E - 4ft Panel (1180x1603mm)	3	ODM1160PP	Section E - 4ft Panel (1180x1603mm)	2
ODAMPEA6	Apex Section - Back	1	ODAMDEA6	Apex Section - Door	1	ODAMPEA6	Apex Section - Back	1	ODAMPEA6	Apex Section - Back	1
ODAMDEA6	Apex Section - Door	1	MSDDR	Door	1	ODAMDEA6	Apex Section - Door	1	ODAMDEA6	Apex Section - Door	1
MSDDR	Door	1	MSBFL46	Floor	2	MSDDR	Door	1	MSDDR	Door	1
MSBFL46	Floor	2	28121637PDT	Slamming Strip (28x12x1637mm)	1	MSBFL46	Floor	2	MSBFL46	Floor	2
28121637PDT	Slamming Strip (28x12x1637mm)	1	282806590DT	Door Batten (28x28x590mm)	1	28121637PDT	Slamming Strip (28x12x1637mm)	1	28121637PDT	Slamming Strip (28x12x1637mm)	1
28160550DT	Weather Strip (38x12x1710mm)	3	28281196	Roof Support Strip (28x28x1196)	4	28160550DT	Weather Strip (38x12x1710mm)	3	28160550DT	Weather Strip (38x12x1710mm)	1
28280548DT	Interior Sill (28x28x548mm)	2	37281124KD	Beam - Truss (37x28x1124)	8	28280548DT	Interior Sill (28x28x548mm)	2	28280548DT	Interior Sill (28x28x548mm)	4
282806590DT	Door Batten (28x28x590mm)	1	38121710PDT	Weather Strip (38x12x1710mm)	1	38121710PDT	Weather Strip (38x12x1710mm)	1	282806590DT	Door Batten (28x28x590mm)	1
28281196	Roof Support Strip (28x28x1196)	4	44161583DT	Cover Strip (44x16x1583mm)	7	28281196	Roof Support Strip (28x28x1196)	4	28281196	Roof Support Strip (28x28x1196)	4
37281124KD	Beam - Truss (37x28x1124)	8	45451015PAI63	Fascia (59x12x1145)	2	37281124KD	Beam - Truss (37x28x1124)	8	37281124KD	Beam - Truss (37x28x1124)	8
38121710PDT	Weather Strip (38x12x1710mm)	1	59121145PAI63DT	OSB Sheet - Roof	4	45451015PAI63	Fascia (59x12x1145)	2	38121710PDT	Weather Strip (38x12x1710mm)	1
44161583DT	Cover Strip (44x16x1583mm)	8	OSB119611058	OSB Sheet - Roof	4	59121145PAI63DT	OSB Sheet - Roof	4	44161583DT	Cover Strip (44x16x1583mm)	7
45451015PAI63	Central Beam - Truss (45x45x1015)	2	FIN20010512DT	Finial	1	OSB119611058	OSB Sheet - Roof	4	45451015PAI63	Central Beam - Truss (45x45x1015)	2
59121145PAI63DT	OSB Sheet - Roof	4	FELT78BL	Felt	1	FIN20010512DT	Finial	1	59121145PAI63DT	OSB Sheet - Roof	4
OSB119611058	OSB Sheet - Roof	4				FELT78BL	Felt	1	OSB119611058	OSB Sheet - Roof	4
FIN20010512DT	Finial	1							FIN20010512DT	Finial	1
FELT78BL	Felt	1							FELT78BL	Felt	1

Shiplap Apex 8' x 6' - 2 Windows (SDA68M)		
Part Code	Description	No.
SDM85PPP	Section D - 3ft Panel (885 x 1603mm)	2
SDM50PPP	Section C - 2ft Panel (590 x 1603mm)	4
SDM1180WP	Section E - 4ft Window Panel (1180x1603)	1
SDM1160PP	Section E - 4ft Panel (1180x1603mm)	2
SDAMPEA6	Apex Section - Back	1
SDAMDEA6	Apex Section - Door	1
MSDDR	Door	1
MSBFL46	Floor	2
28120550PDT	Window Cover Strip (28x12x550mm)	3
28121637PDT	Slamming Strip (28x12x1637mm)	1
28280548DT	Interior Sill (28x28x548mm)	2
282806590DT	Door Batten (28x28x590mm)	1
28281196	Roof Support Strip (28x28x1196)	4
37281124KD	Beam - Truss (37x28x1124)	8
38121710PDT	Weather Strip (38x12x1710mm)	1
44161583DT	Cover Strip (44x16x1583mm)	7
45451015PAI63	Central Beam - Truss (45x45x1015)	2
59121145PAI63DT	OSB Sheet - Roof	4
OSB119611058	OSB Sheet - Roof	4
FIN20010512DT	Finial	1
FELT78BL	Felt	1

(The parts do not have codes on them. They are listed above should you need to order one.)

PRESSURE TREATED APEX SHEDS

SELECT YOUR CHOSEN SHED & CHECK YOU HAVE ALL YOUR PARTS.

Overlap Apex 8' x 6' - 2 Windows (OPA683M)			Overlap Apex 8' x 6' - No Windows (OPA68NMM)			Overlap Apex 8' x 6' - 2 Windows (OPA682MM)			Overlap Apex 8' x 6' - 4 Windows (OPA684MMF)		
Part Code	Description	No.	Part Code	Description	No.	Part Code	Description	No.	Part Code	Description	No.
OPM85PP	Section D - 3ft Panel (885 x 1603mm)	2	OPM85PP	Section D - 3ft Panel (885 x 1603mm)	2	OPM85PP	Section D - 3ft Panel (885 x 1603mm)	2	OPM85PP	Section D - 3ft Panel (885 x 1603mm)	2
OPM90PP	Section C - 2ft Panel (590 x 1603mm)	4	OPM90PP	Section C - 2ft Panel (590 x 1603mm)	2	OPM90PP	Section C - 2ft Panel (590 x 1603mm)	2	OPM90PP	Section C - 2ft Panel (590 x 1603mm)	2
OPM1180WP	Section E - 4ft Window Panel (1180x1603mm)	1	OPM1180WP	Section E - 4ft Window Panel (1180x1603mm)	4	OPM1180WP	Section E - 4ft Window Panel (1180x1603mm)	1	OPM1180WP	Section E - 4ft Window Panel (1180x1603mm)	2
OPM1180PP	Section E - 4ft Panel (1180x1603mm)	2	OPM1180PP	Apex Section - Back	1	OPM1180PP	Section E - 4ft Panel (1180x1603mm)	3	OPM1180PP	Section E - 4ft Panel (1180x1603mm)	2
OPAMPEA6	Apex Section - Back	1	OPAMPEA6	Apex Section - Back	1	OPAMPEA6	Apex Section - Back	1	OPAMPEA6	Apex Section - Back	1
OPAMDEA6	Apex Section - Door	1	OPAMDEA6	Apex Section - Door	1	OPAMDEA6	Apex Section - Door	1	OPAMDEA6	Apex Section - Door	1
MSPDR	Door	1	MSPDR	Door	2	MSPDR	Door	1	MSPDR	Door	1
MSBFL46	Floor	2	MSBFL46	Floor	1	MSBFL46	Floor	2	MSBFL46	Floor	2
28121637PPT	Slamming Strip (28x12x1637mm)	1	28121637PPT	Slamming Strip (28x12x1637mm)	1	28121637PPT	Slamming Strip (28x12x1637mm)	1	28121637PPT	Slamming Strip (28x12x1637mm)	1
2828050PT	Door Batten (28x28x590mm)	1	2828050PT	Door Batten (28x28x590mm)	1	2828050PT	Door Batten (28x28x590mm)	1	2828050PT	Door Batten (28x28x590mm)	1
28160550PT	Roof Support Strip (28x28x1196)	3	28160550PT	Roof Support Strip (28x28x1196)	4	28160550PT	Roof Support Strip (28x28x1196)	3	28160550PT	Roof Support Strip (28x28x1196)	6
28280548PT	Interior Sill (28x28x548mm)	2	37281124KD	Beam - Truss (37x28x1124)	8	28280548PT	Interior Sill (28x28x548mm)	2	28280548PT	Interior Sill (28x28x548mm)	4
28280590PT	Door Batten (28x28x590mm)	1	38121710PPT	Weather Strip (38x12x1710mm)	1	28280590PT	Door Batten (28x28x590mm)	1	28280590PT	Door Batten (28x28x590mm)	1
28281196	Roof Support Strip (28x28x1196)	4	44161583PT	Cover Strip (44x16x1583mm)	7	28281196	Roof Support Strip (28x28x1196)	4	28281196	Roof Support Strip (28x28x1196)	4
37281124KD	Beam - Truss (37x28x1124)	8	45451015PAI63	Central Beam - Truss (45x45x1015)	2	37281124KD	Beam - Truss (37x28x1124)	8	37281124KD	Beam - Truss (37x28x1124)	8
38121710PPT	Weather Strip (38x12x1710mm)	1	5912145PA163PT	Fascia (59x12x1145)	4	38121710PPT	Weather Strip (38x12x1710mm)	1	38121710PPT	Weather Strip (38x12x1710mm)	1
44161583PT	Cover Strip (44x16x1583mm)	8	OSB119811058	OSB Sheet - Roof	4	44161583PT	Cover Strip (44x16x1583mm)	7	44161583PT	Cover Strip (44x16x1583mm)	7
45451015PAI63	Central Beam - Truss (45x45x1015)	2	FIN20010512PT	Final	1	45451015PAI63	Central Beam - Truss (45x45x1015)	2	45451015PAI63	Central Beam - Truss (45x45x1015)	2
5912145PA163PT	Fascia (59x12x1145)	4	FELT78BL	Felt	1	5912145PA163PT	Fascia (59x12x1145)	4	5912145PA163PT	Fascia (59x12x1145)	4
OSB119811058	OSB Sheet - Roof	4				OSB119811058	OSB Sheet - Roof	2	OSB119811058	OSB Sheet - Roof	4
FIN20010512PT	Final	1				FIN20010512PT	Final	4	FIN20010512PT	Final	4
FELT78BL	Felt	1				FELT78BL	Felt	1	FELT78BL	Felt	1

(The parts do not have codes on them. They are listed above should you need to order one.)

TREATED REVERSE APEX SHEDS

SELECT YOUR CHOSEN SHED & CHECK YOU HAVE ALL YOUR PARTS.

Pressure Treated Overlap Reverse Apex 8' x 6' (OPR86M)			Dip Treated Overlap Reverse Apex 8' x 6' (ODR86M)		
Part Code	Description	No.	Part Code	Description	No.
OPM1180PP	Section E - 4ft Panel (1180x1603mm)	2	ODM1180PP	Section E - 4ft Panel (1180x1603mm)	2
OPM865PP	Section D - 3ft Panel (885 x 1603mm)	4	ODM865PP	Section D - 3ft Panel (885 x 1603mm)	4
OPM1160WP	Section E - 4ft Window Panel (1180x1603mm)	1	ODM1160WP	Section E - 4ft Window Panel (1180x1603mm)	1
OPM295PP	Section A - Tilt Panel (295x 1603mm)	2	ODM295PP	Section A - Tilt Panel (295x 1603mm)	2
OPM1180PFP	4ft Extension Panel	3	ODM1180PFP	4ft Extension Panel	3
OPM1180DFP	4ft extension - front door panel	1	ODM1180DFP	4ft extension - front door panel	1
OPRAMPEA6	Apex Section	2	ODRAMPEA6	Apex Section	2
MSDFR	Door	1	MSDFR	Door	1
MSBFL46	Floor	2	MSBFL46	Floor	2
28121637PPT	Slamming Strip (28x12x1637mm) Window Cover Strip	1	28121637PDT	Slamming Strip (28x12x1637mm) Window Cover Strip	1
2816055OPT	Interior Sill (28x16x550mm)	3	2816055ODT	Interior Sill (28x16x550mm)	3
2820054OPT	Door Batten (28x28x548mm)	2	2820054ODT	Door Batten (28x28x548mm)	2
2820050OPT	Door Batten (28x28x500mm)	1	2820050ODT	Door Batten (28x28x500mm)	1
28281196	Roof Support Strip (28x28x1196)	4	28281196	Roof Support Strip (28x28x1196)	4
37281124KD	Beam - Truss (37x28x1124)	8	37281124KD	Beam - Truss (37x28x1124)	8
3812170PPT	Weather Strip (38x12x1710mm)	1	3812170PDT	Weather Strip (38x12x1710mm)	1
4416181OPT	Cover Strip (44x16x1810mm)	8	4416181ODT	Cover Strip (44x16x1810mm)	8
45451019PAM63	Central Beam - Truss (45x45x1015)	2	45451019PAM63	Central Beam - Truss (45x45x1015)	2
59121145PAM63PT	Fascia (59x12x1145)	4	59121145PAM63DT	Fascia (59x12x1145)	4
RPET590	Window	2	RPET590	Window	2
OSB119611058	OSB Sheet - Roof	4	OSB119611058	OSB Sheet - Roof	4
FEL178BL	Felt	1	FEL178BL	Felt	1

(The parts do not have codes on them. They are listed above should you need to order one.)