

Assembly Instruction

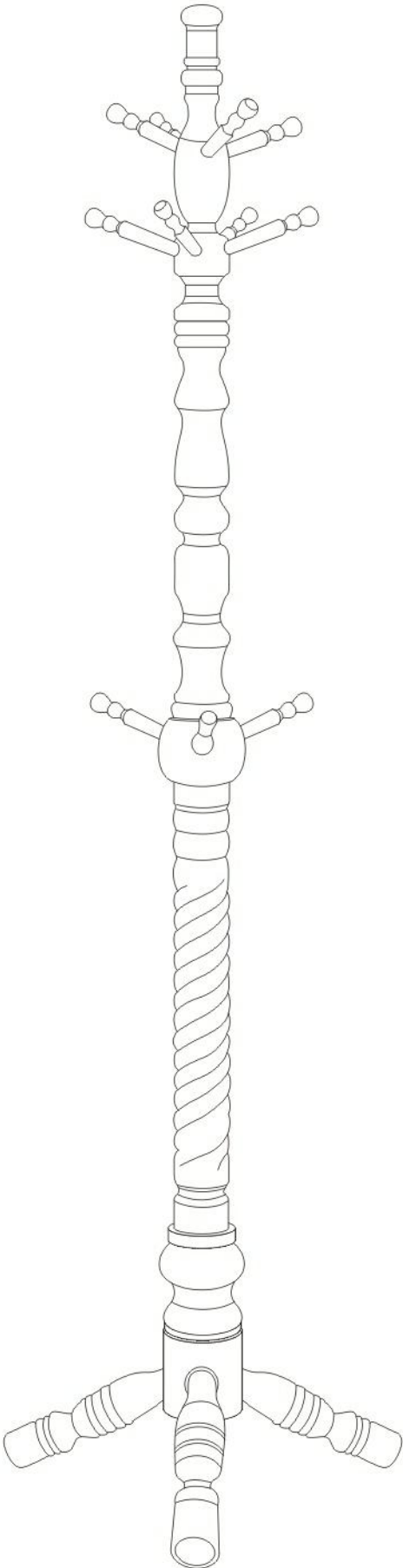

Thank you for choosing our product.

We are committed to delivering exceptional customer service to ensure your satisfaction.

Parts Confirmation:

- Upon unpacking, verify that all parts listed in the manual are present.
- If any parts are missing or incorrect, please notify us immediately. We will promptly arrange replacements, or other solutions to ensure the issue is resolved.







Assembly Guidance:

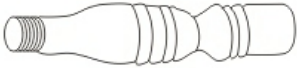
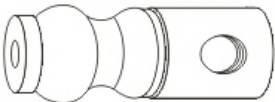

- Carefully review the instruction manual before assembly.
- The manual has detailed steps, but it might not cover all situations. If you need help or have questions, contact us and we'll respond quickly.

Shipping Note

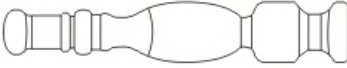
- If you purchased multiple packs, kindly note that the items in your order might come in separate packages. We appreciate your patience during delivery.

Parts List

Number	Part	Qty
1		X3PC
2		X1PC
3		X1PC
4		X1PC
5		X1PC
6		X1PC
7		X11PC

Number	Name	Part	Qty
A	Short 10x60mm		X2PC
B	Long 10x150mm		X1PC

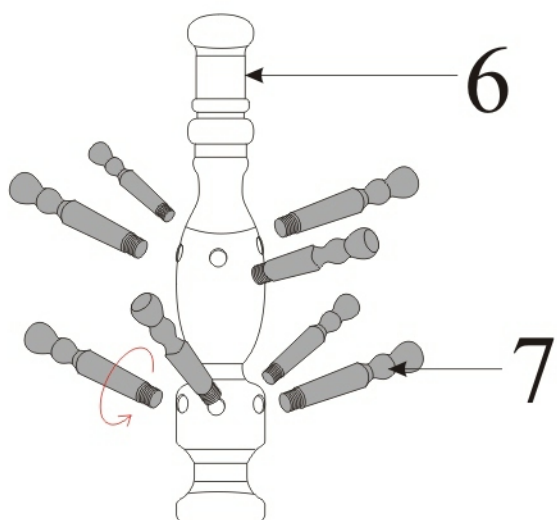
01

Firstly, screw the suspension bracket (7) into the support pillar (6) according to the angle

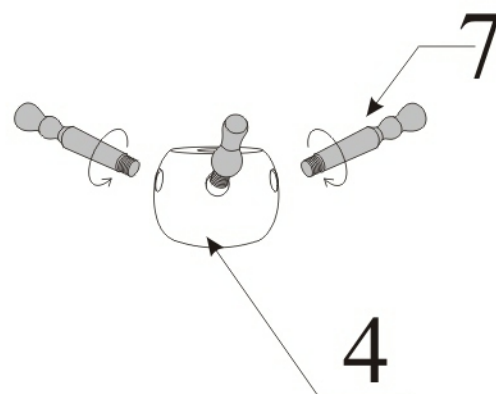
02

Then screw the (7) suspension into the (4) sphere along the angle

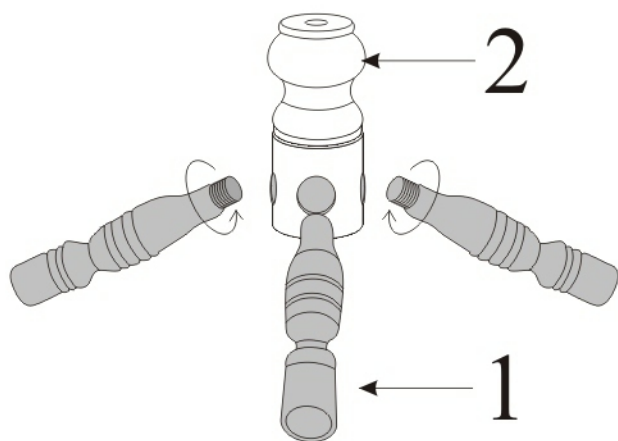
03

Twist (1) into (2) the pillar according to the angle

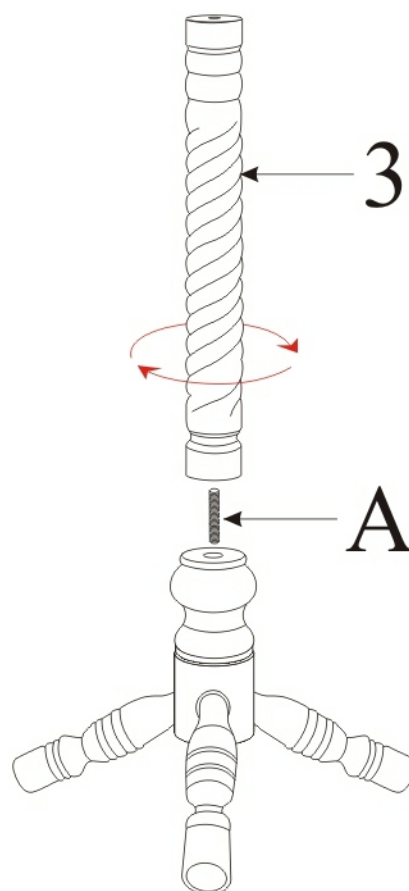
04

Screw screw A into the (2) pillar for 3-4 turns, then screw (3) in and fix it securely

04

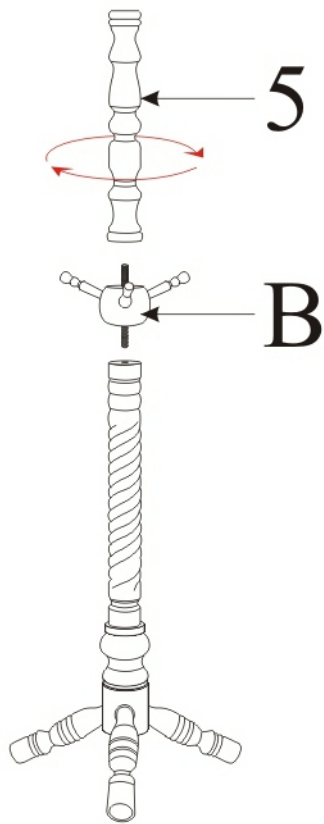

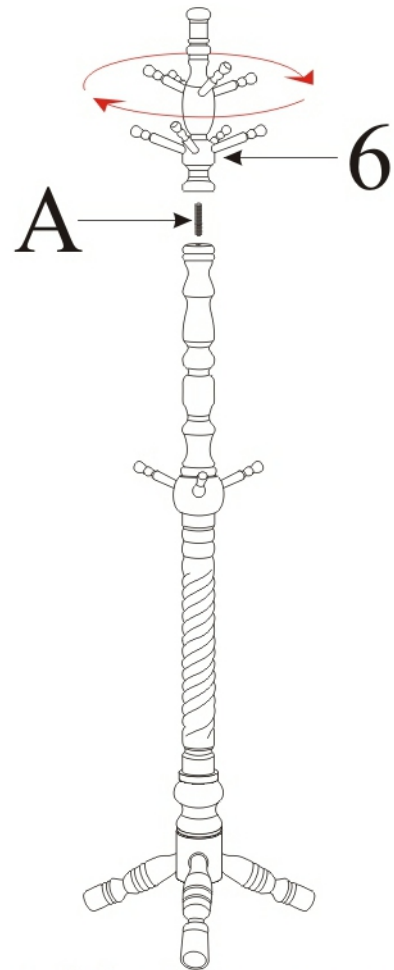

Screw the long screw in 3-4 turns, then fit the spherical body onto it, and finally screw in (5) to install and fix it securely

05





Finally, install the short screw and tighten (6) securely, completing the installation

Safety Guidelines

-  Periodically inspect and tighten bolts to prevent loosening during use.
-  Ensure all hardware remains securely fastened before using.

Care Instructions

-  Avoid placing hot items, direct sunlight, or harsh chemicals on the furniture
-  Wipe dust with a soft, clean, lint-free cloth.
-  Note: Indoor Use Only: Do not place the furniture outdoors or in damp environments.

Thank you for your purchase