

USE AND CARE MANUAL

FLOOR LAMP
Model number: 21594

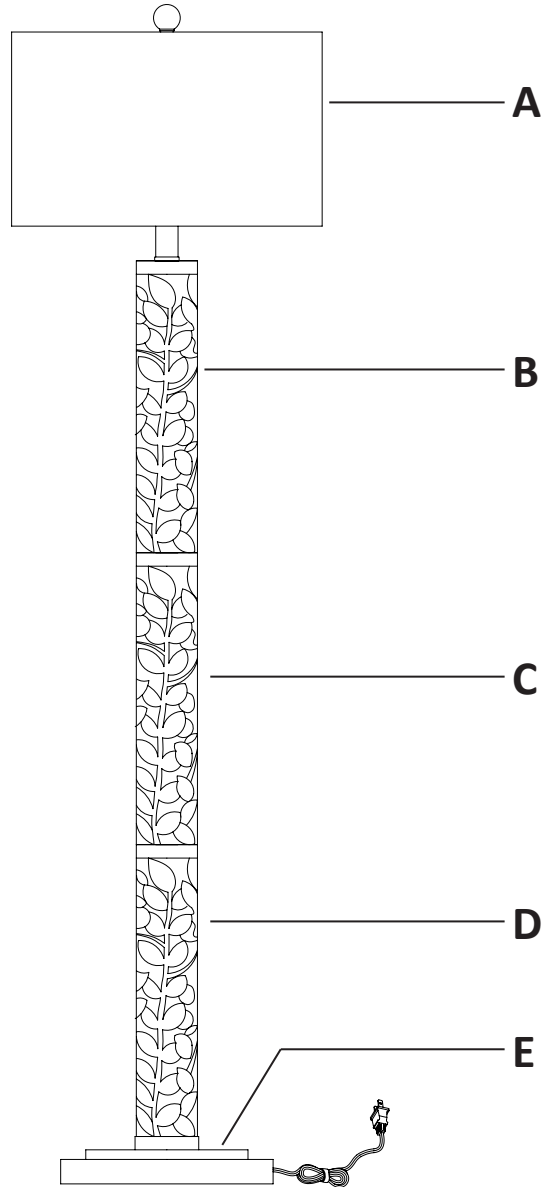
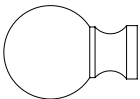
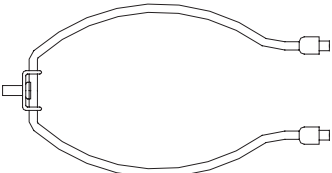
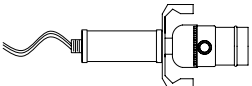

Hardware (Parts are not to scale)

H1 Finial (Pre-assembled to harp (H2)) 1 pc		H2 Harp 1 pc		H3 Socket assembly (connecting to column (B)) 1 pc	
---	---	-------------------------------	--	--	---

**THIS MANUAL CONTAINS IMPORTANT SAFETY INFORMATION. PLEASE READ AND
KEEP FOR FUTURE REFERENCE.**

IMPORTANT SAFETY INFORMATION

- This lamp is for indoor use only. The lamp should not be used near water. Never immerse the lamp in water or other liquids.
- Never cover the lamp with any object including cloth or paper as this is a fire hazard.
- Do not handle the bulb immediately after the light is turned off as it will be hot.
- This portable lamp has a polarized plug (one blade is wider than the other) as a safety feature to reduce the risk of electric shock. This plug will fit into a polarized outlet only one way. If the plug does not fit fully into the outlet, reverse the plug. If it still does not fit, contact a qualified electrician. Never use with an extension cord unless plug can be fully inserted. Do not alter the plug.

PREPARATION

- Before beginning assembly, installation or operation of product, make sure all parts are present. Compare parts with package contents list and diagram on previous page. If any part is missing or damaged, do not attempt to assemble, install or operate the product. Contact customer service for replacement parts.

ASSEMBLY

1 Assembling the columns to the base

- Pull the excess power cord through the base (E).
- Tighten the lower column (D) onto the base (E).
- Tighten the middle column (C) onto the lower column (D)
- Tighten the upper column (B) onto the middle column (C).

NOTE: Do not twist the power cord.

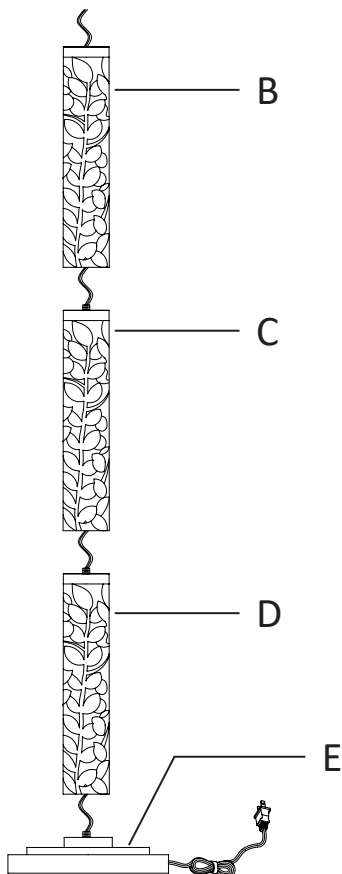

2 Assembling the socket assembly to the upper column

- Pull the excess power cord through the base (E).
- Tighten the socket assembly (H3) onto the upper column (B).

NOTE: Do not twist the power cord.

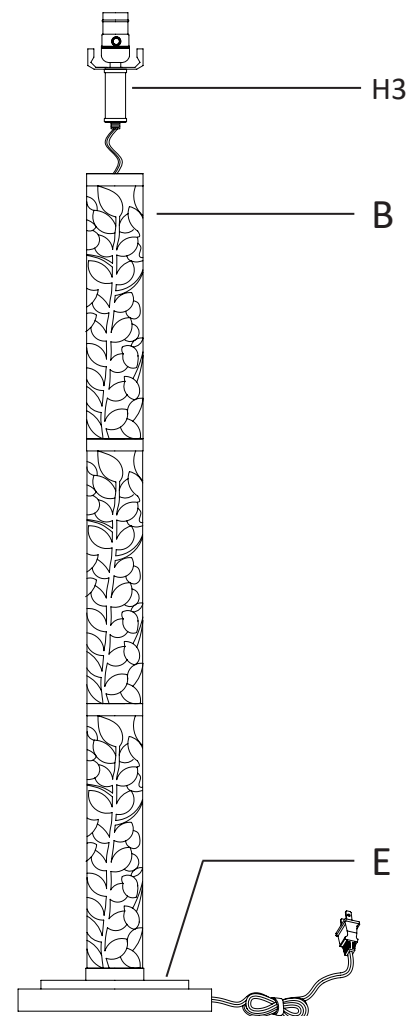

ASSEMBLY (continued)

3 Assembling the harp

- Insert the harp (H2) prongs into the saddle of the socket assembly (H3) and slide the retaining covers over joints to secure the harp.

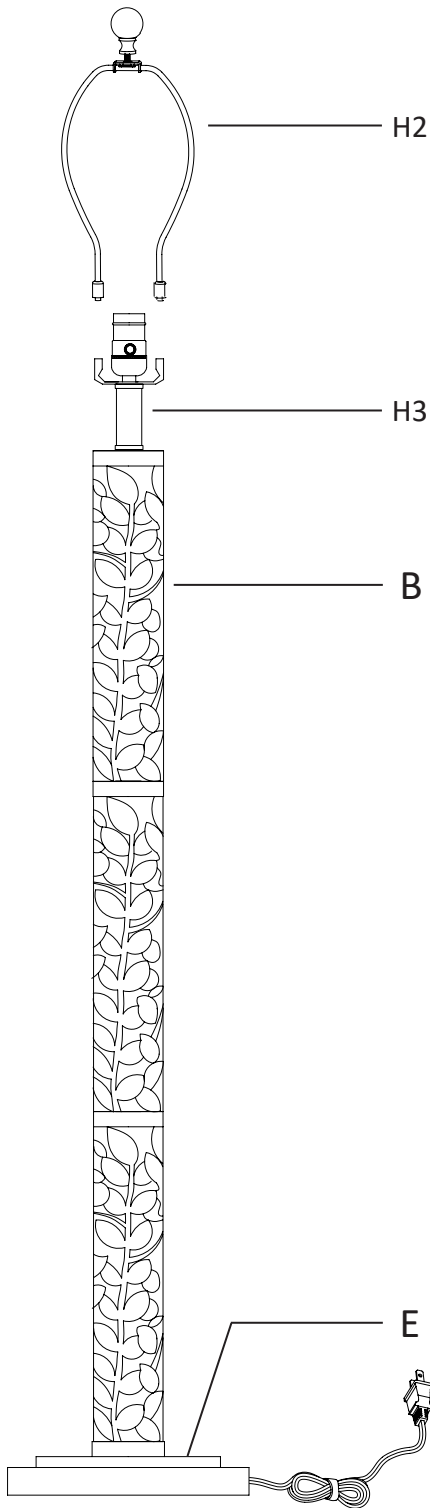

4 Installing the bulb

- Install the light bulb (not provide) into the socket. Use one **MAX 150W 3-way medium base (E26) type "A" bulb** (recommended).

NOTE: You can also use one **MAX 16W 3-way medium base (E26) self-ballasted LED bulb**. Do not exceed the recommended wattage.

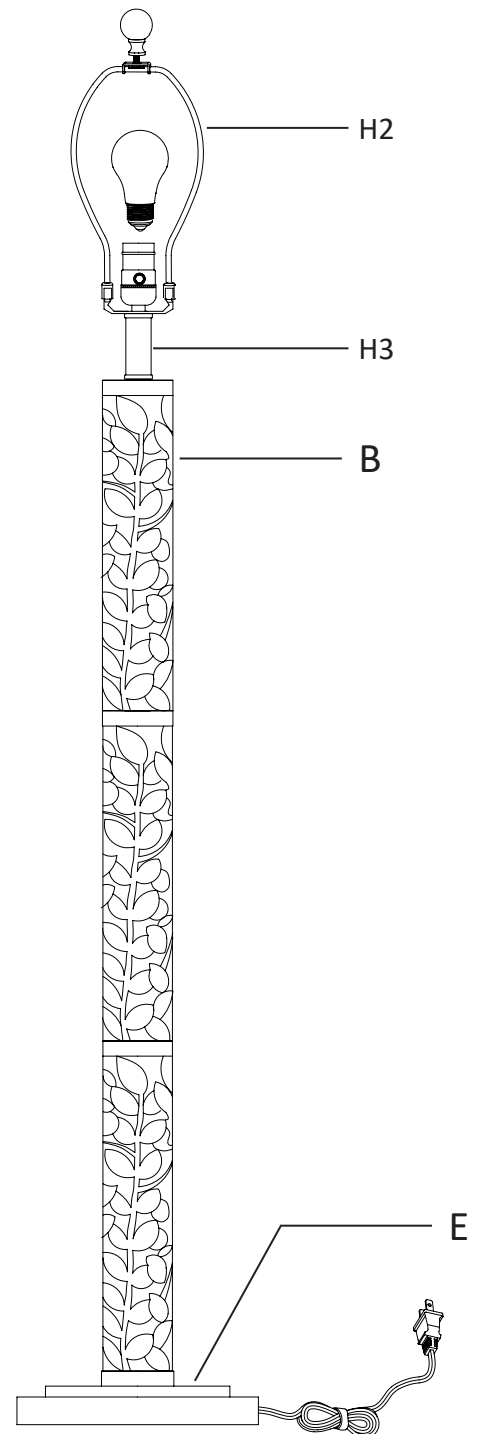

ASSEMBLY (continued)

5 Assembling the shade

- Unscrew the finial (H1) from the harp (H2).
- Place the shade (A) onto the harp (H2) and secure with the finial (H1).
- Plug into the wall outlet, turn the switch clockwise and enjoy.

NOTE: Grasp the finial (H1) to adjust the shade assembly to level if shade is skewed. Remove the plastic cover from the shade before using.

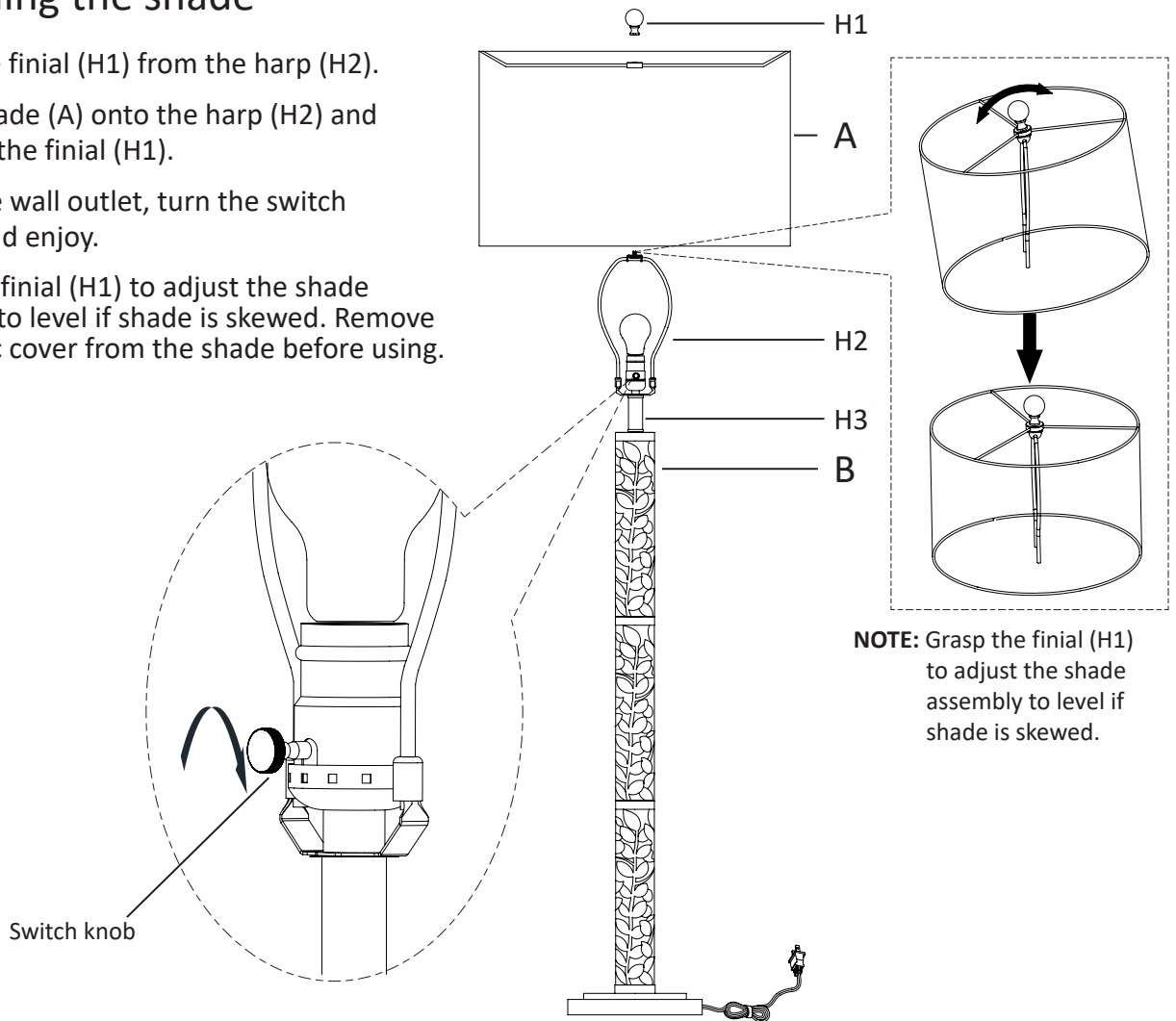

NOTE: Grasp the finial (H1) to adjust the shade assembly to level if shade is skewed.

CLEANING

- Do not use any cleaners with chemicals, solvents, or harsh abrasives. Use only a dry, soft cloth to dust or wipe carefully.
- To clean the fixture, pull the plug from the wall outlet. Use a dry or slightly dampened, clean cloth to wipe the exterior surface of the fixture.

TROUBLESHOOTING

- The light does not come on at all:
 - a) Ensure whether the bulb is burned out.
 - b) Ensure the power supply is turned on.
 - c) Ensure the cord is plugged into an outlet.
 - d) Ensure the circuit breaker is set in the "ON" position.
- Fuse blows or circuit trips when light is turned on.
 - a) Check for crossed wires, ensure wiring is correct.