

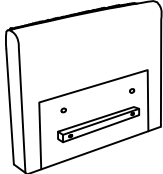

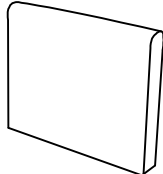

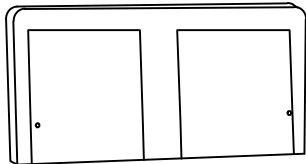

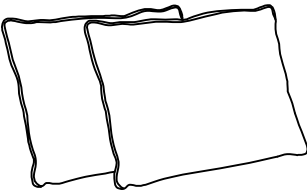

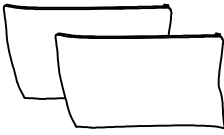
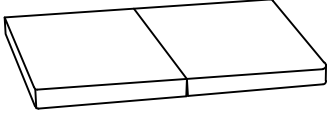
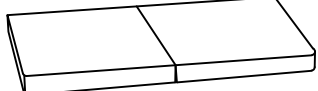
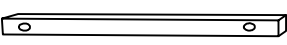
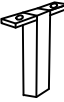
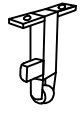
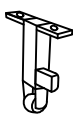
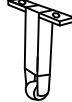
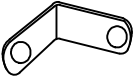
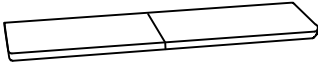

ASSEMBLY INSTRUCTION

A Metal frame x1 	B Arm-L x1 	C Arm-R x1 	D Backrest x1 		
E Cushion x2 	F Arm Pillow x2 	G Seat cushion-L x1 	H Seat cushion-S x1 		
I Middle bar x1 	J Midfoot leg x1 	K Front leg x1 	L Front leg x1 	N Side leg x2 	M Angle iron x2 
O Front rail x1 	1 Bolt x12 6x20 	2 Washer x30 	3 Allen wrench 8M 	4 Bolt x4 8x40m 	5 Allen wrench 6M 
6 Bolt x4 8x30 	8 Bolt x6 8x60 	9 Bolt x4 8x25 	10 Leg x4 		



STEP1:

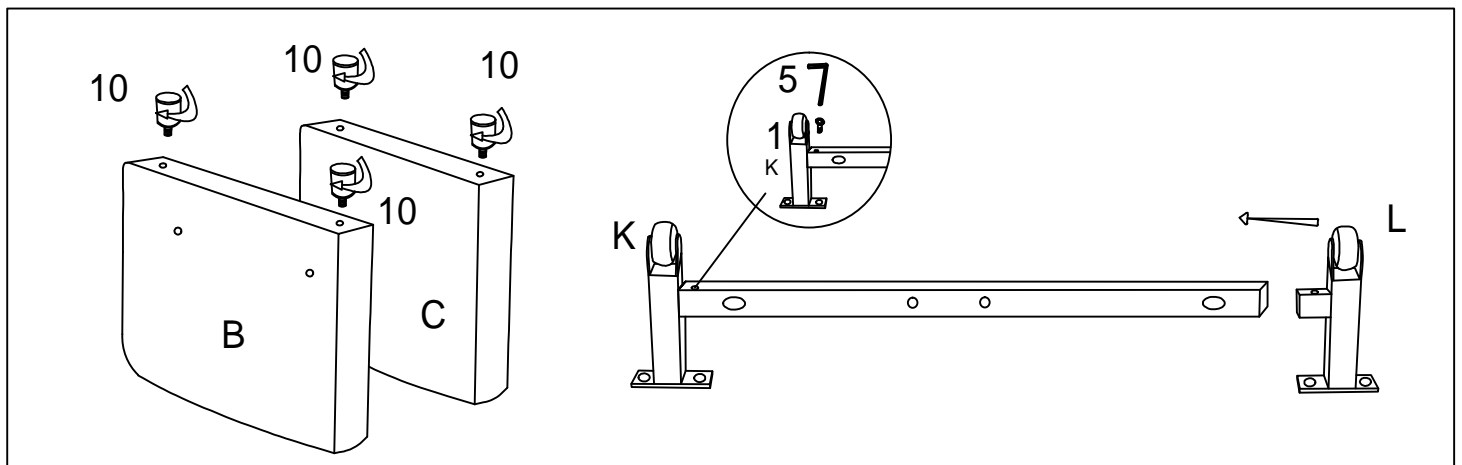
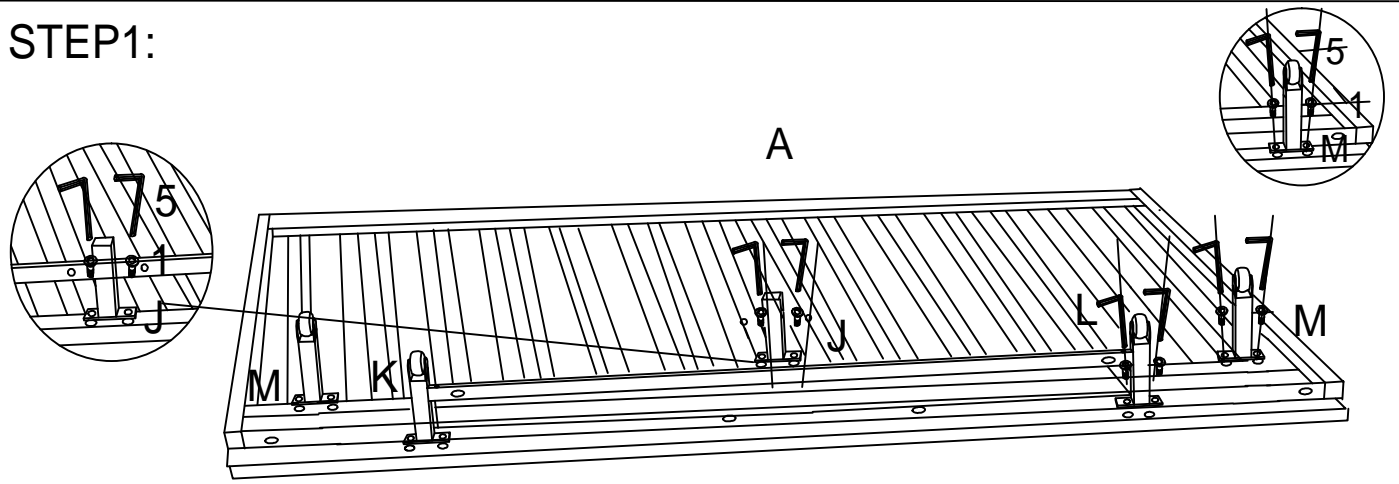

STEP2:

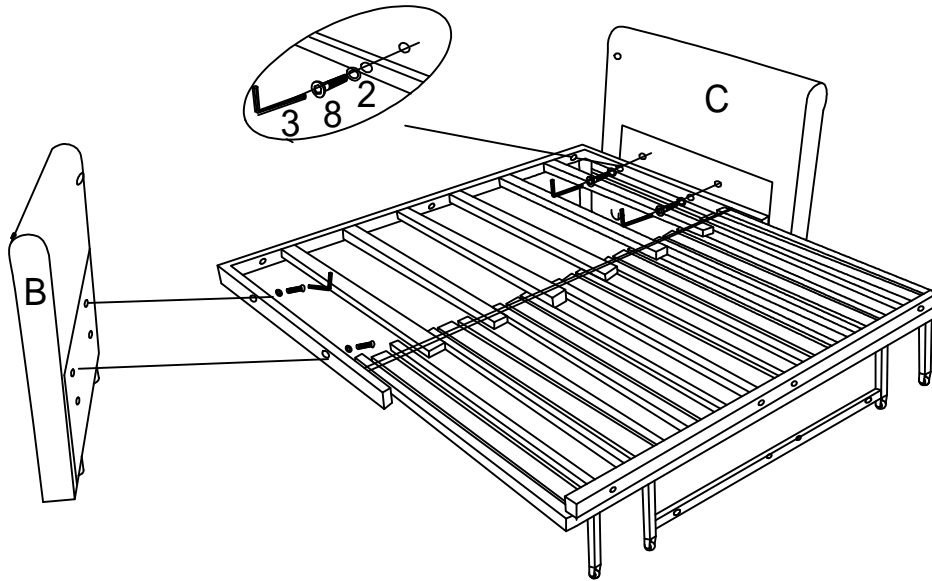

STEP3:

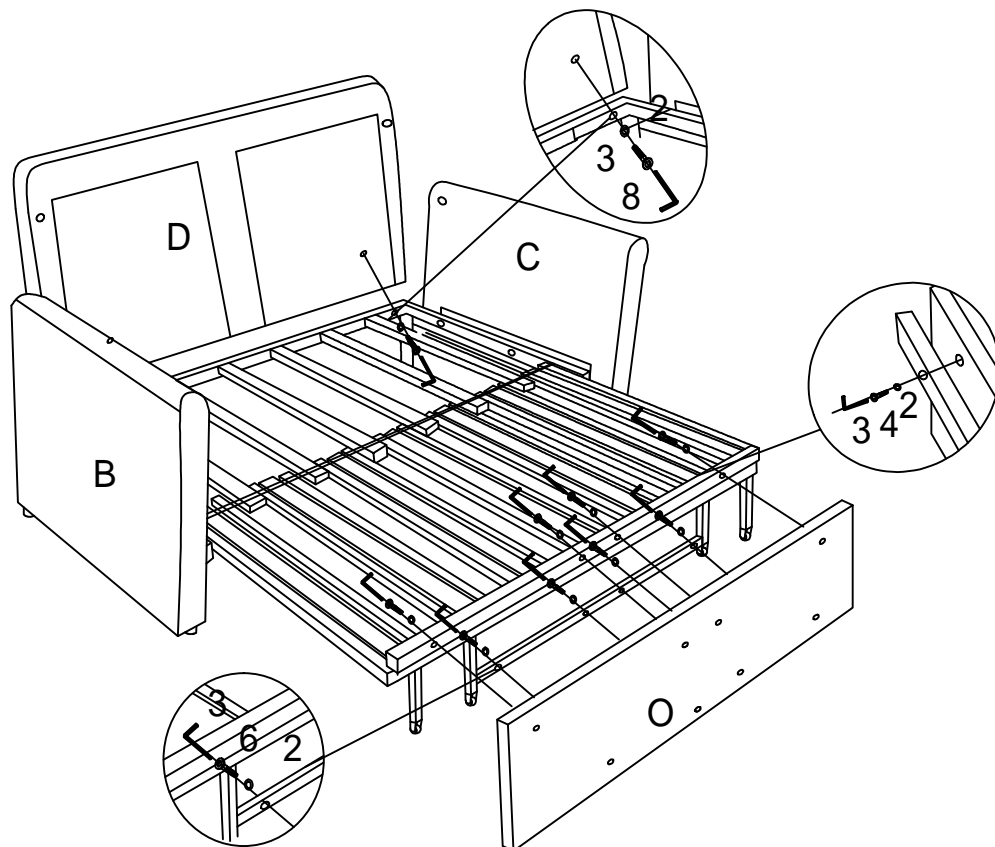

STEP4:

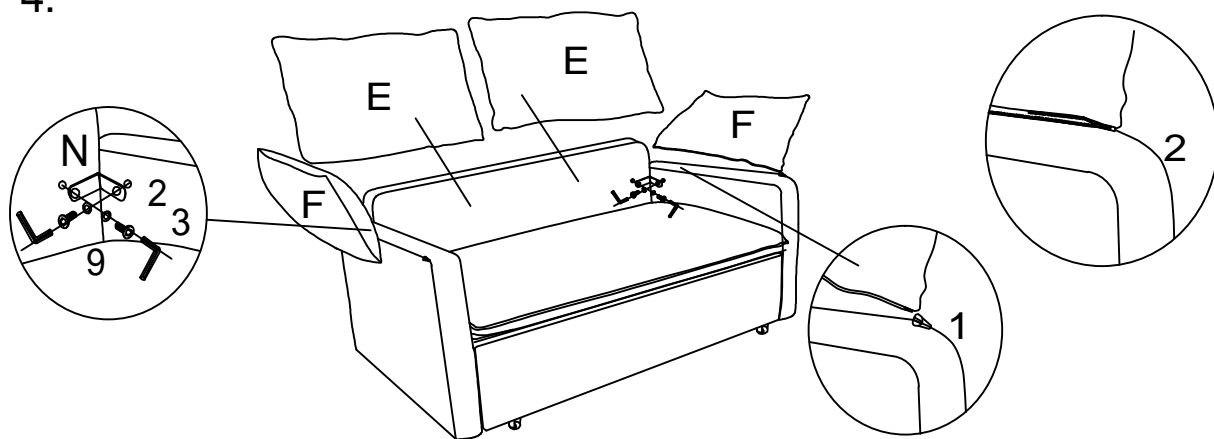

STEP5:

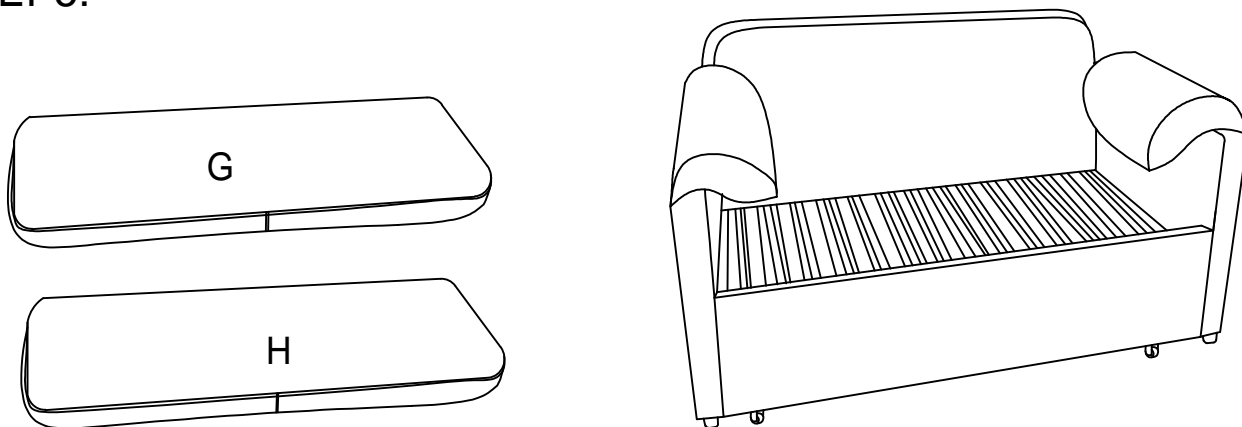

STEP6:

