

Assembly Guide: Stainless Steel Shelving

IMPORTANT: READ FIRST

- Check the parts list to make sure all parts are included and in good condition.
- Read and follow each step carefully. It is very important that each step of instruction is performed in the correct order.
- To clean the product, use a general purpose cleaner and a soft cloth.

Stainless Steel Cleaning

The following are some important tips on cleaning your stainless steel:

- There are a number of reliable stainless steel cleaners on the market
- Use only alkaline, alkaline-chlorinated or non-chloride cleaners
- Avoid hydrochloric acid (muriatic acid) on your stainless steel
- Always use a non-abrasive cleaning tool such as a soft cloth or plastic scouring pad
- Avoid steel pads, wire brushes and scrapers
- Always clean in the direction of the polishing marks by locating the lines or grain and scrub in a motion parallel to them
- If you do end up using a chlorinated cleaner, be sure to rinse thoroughly and dry it, immediately
- Air dry your equipment

WARRANTY

We warrant this product to be free from defects in material and workmanship and agrees to remedy any such defect. This warranty covers five years from date of original purchase. This is solely limited to the repair or replacement of defective furniture components and no assembly labor is included.

This warranty does not apply to any product which has been improperly assembled, subjected to misuse or abuse or which has been altered or repaired in any way. Liability for consequential damages is excluded to the extent exclusion is permitted by law. This warranty gives you specific legal rights. Additional warranty rights may be provided by law in some areas.

To obtain warranty services, purchaser must present original bill of sale. Components repaired or replaced are warranted though the remainder of the original warranty period only. The defective components will be repaired or replaced without charge, subject to the terms and conditions described above.

INSTALLATION SITE PREP

Product Weight:

MODEL	SHIPPING WEIGHT	RATING WEIGHT
18B	9 lbs	60 lbs
24B	12 lbs	60 lbs
30B	14 lbs	60 lbs
36B	16 lbs	60 lbs
42B	21 lbs	120 lbs
48B	23 lbs	120 lbs
60B	27 lbs	120 lbs
72B	31 lbs	120 lbs

Basic Notes on Installation:

Required Tools:		
1/8" drill for sheet metal screws	3/8" drill for wall anchors	#2 Phillips head manual screw driver

ASSEMBLY: Frame Mounting

Select the drawing for the size/model purchased.

Note: Use the supplied sheet metal screws to attached to wall studs whenever possible. If wall studs are not available, install using metal wall anchors.

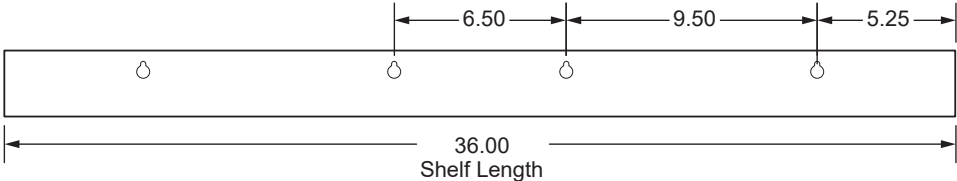
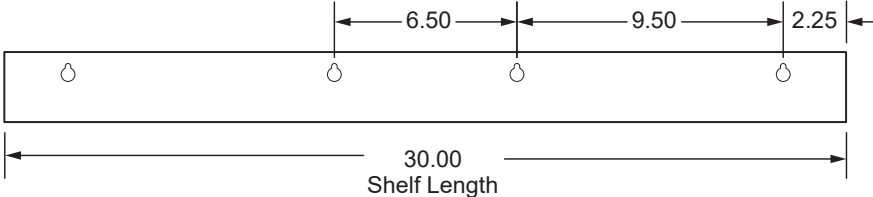
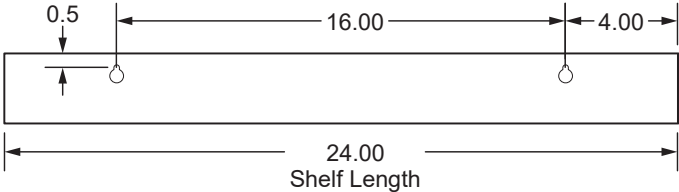
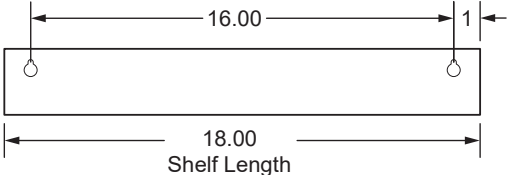

ASSEMBLY: Frame Mounting

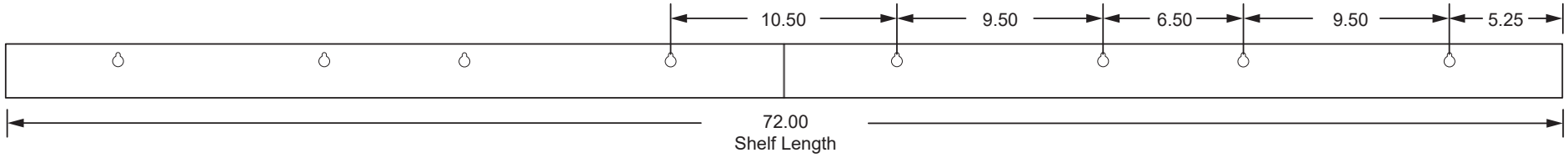
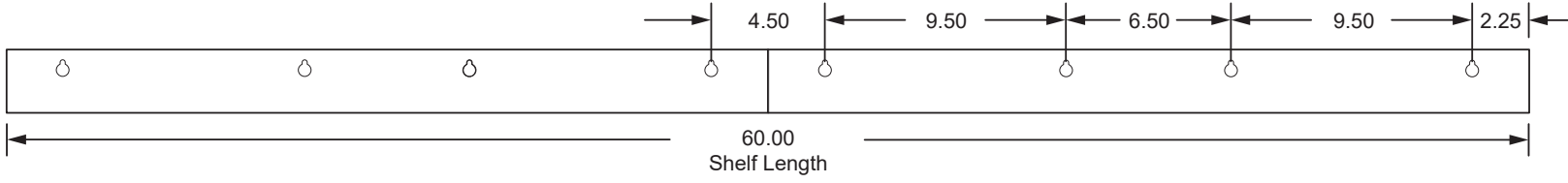
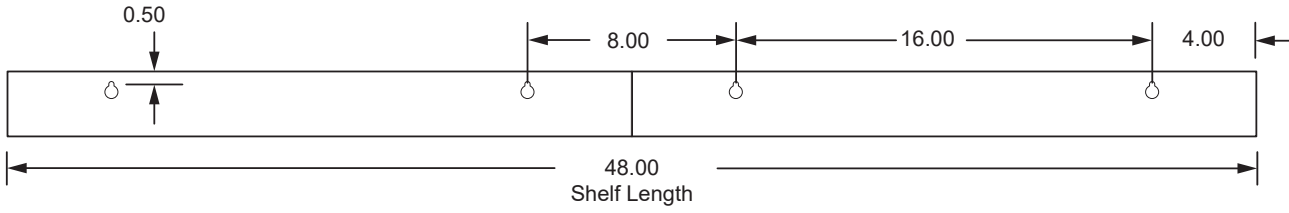
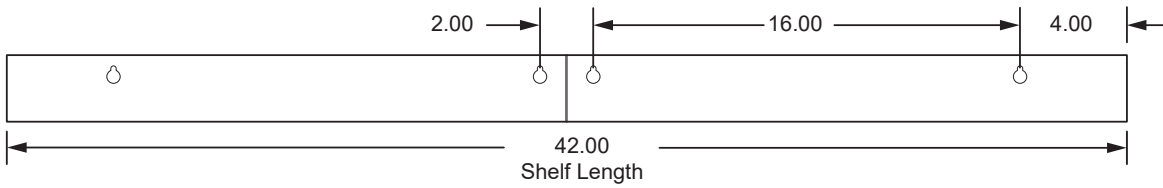

ASSEMBLY: Shelf Frame

1. Drill holes in the appropriate location, based on the measurements for the size/model purchased. 1/8" Drill bit for sheet metal screws. 3/8" Drill bit for wall anchor screws.

Note: Ensure that the holes are drilled level.

2. Place the Shelf Frame on the screws and tighten.

3. Place the SS Shelf over the Shelf Frame.

4. The lip at the back will lock the SS Shelf into place.

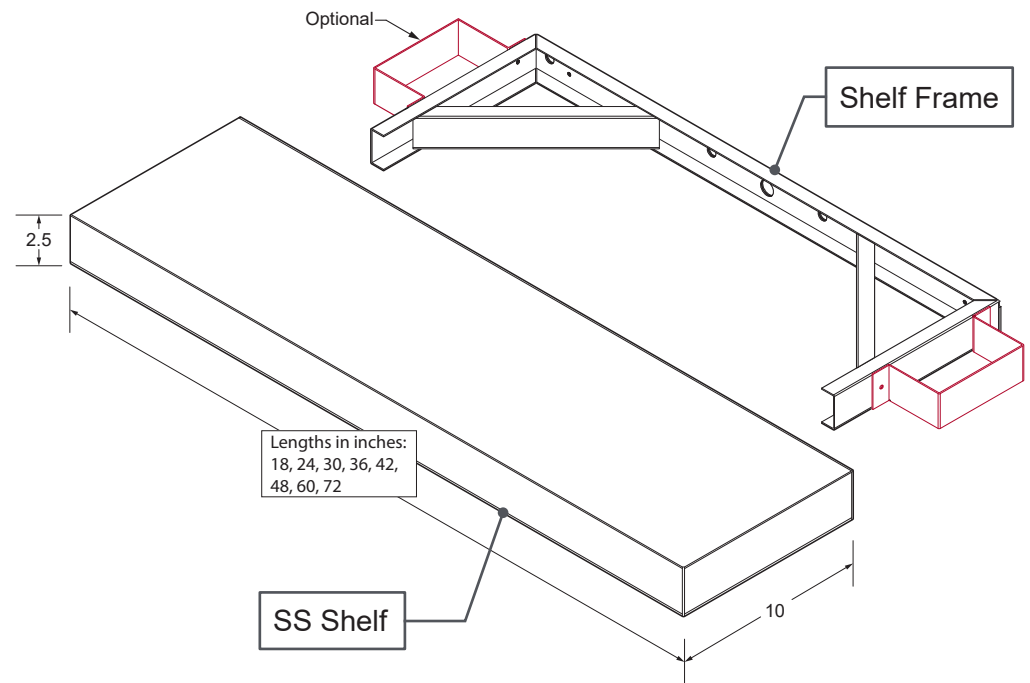

ASSEMBLY: Bracket

For the 60 and 72" shelves, it is recommended that you use the supplied center Bracket.

1. After the Shelf Frame is mounted, slide the supplied center Bracket in between the Shelf Frame.

2. Slide the center Bracket into place, leaving a approximate gap of 5/8" as shown.

3. Place the SS Shelf over the frame, ensuring that bottom of the shelf is resting on the center Bracket.

NOTE: Repeat for additional shelves.

