

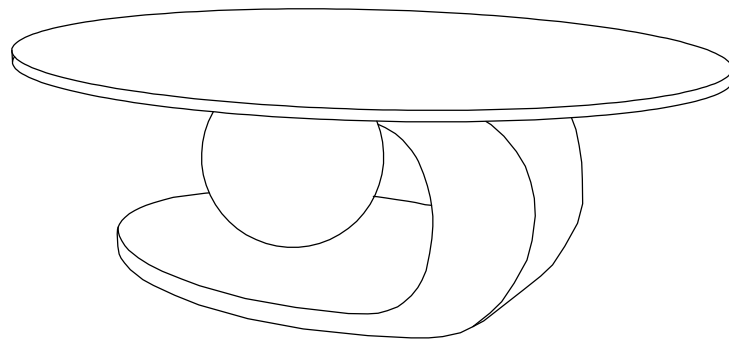



# ASSEMBLY INSTRUCTIONS





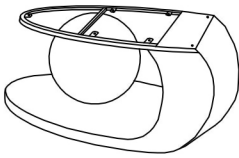

Notice:

1. Follow the installation instructions. Please confirm all accessories are preset before installation.
2. Do not fully tighten the screws during initial assembly. Fully tighten screws only once all pieces which are correctly assembled.
3. If you encounter any problems during installation, please contact our customer service.
4. Please unbox the item from the side with an open-label and put a carpet on the floor to avoid scratching it.

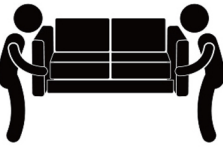
Item no.	Reference Image	Qty
A		X1
B		X1

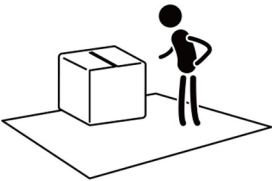
Item no.	Reference Image	Qty
①		X6
②		X5

			
---	---	--	---

Notice:

Compatible tools: Sewdriver or Electric Drilldriver (Not Include )

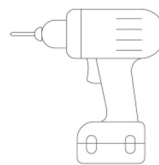
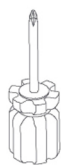

1



② 5PCS

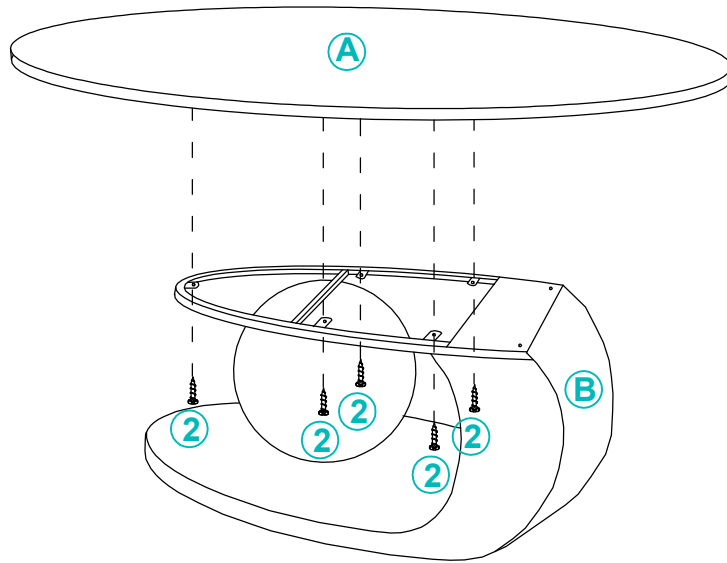

2



① 6PCS

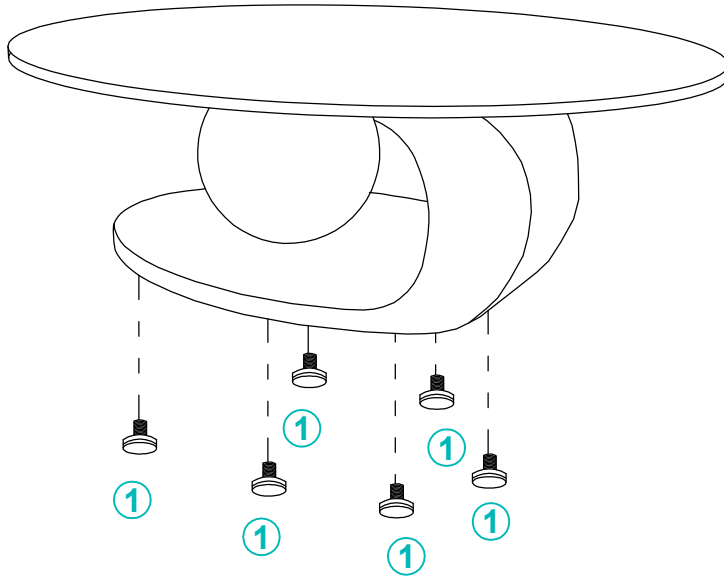

3

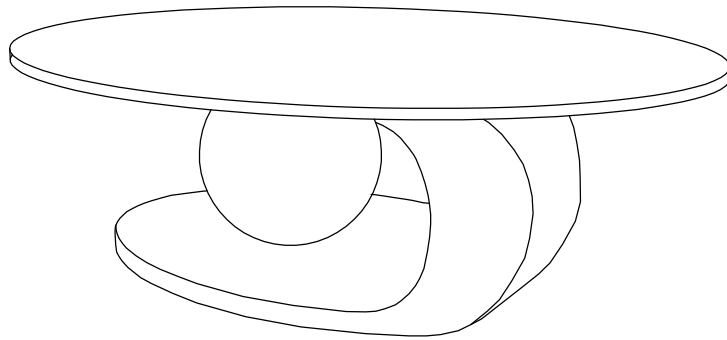

Installation Completed