



SANDUR Armchair Full Woven

W 23 1/4" D 23 1/16" H 31 11/16"

AH 26 5/8" SH 18 1/4"

CH 1 3/8" OSH 19 5/8"

18.1 lbs

Powder coated stainless steel & rope or stainless steel & rope

SANDUR ROPE AND FRAME COMBINATION



White Rope / White Frame



Clay Rope / White Frame



Clay Rope / Stainless Steel Frame

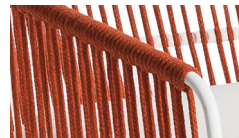

Terra Cotta Rope / White Frame

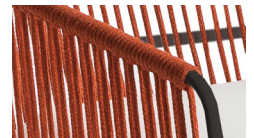

Terra Cotta Rope / Anthracite Frame



Taupe Rope / Stainless Steel Frame



Taupe Rope / Anthracite Frame



Anthracite Rope / Anthracite Frame

SANDUR: CUSHION FABRICS



Canvas Natural

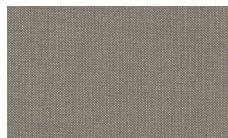

Lantern Slate



Cayenne



Canvas Brick

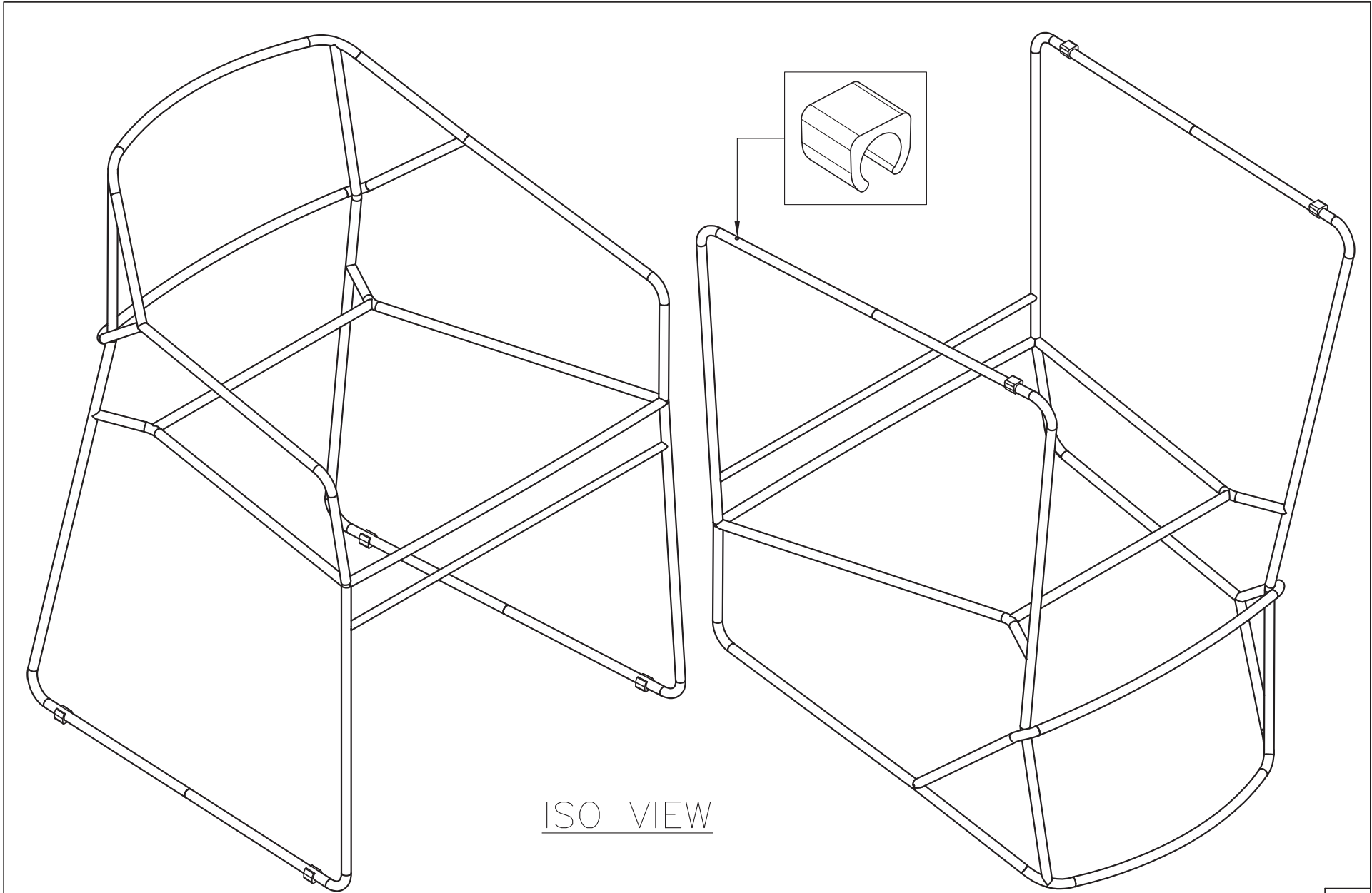

ISO VIEW

FAEOA4-2K/KB

ISO

OASIQ	DWG.NO: FAEOA4-1	TITLE : ISO VIEW	DIM EXT: 590.3x586x805.2 MM.	MATERIAL: SS304	DRAWN BY : Mr.Khanti	FINISH DATE : 13-01-15	TSAI	SCALE : 1:1	P. 2
						BEGIN DATE : 9-01-13	KHAN		

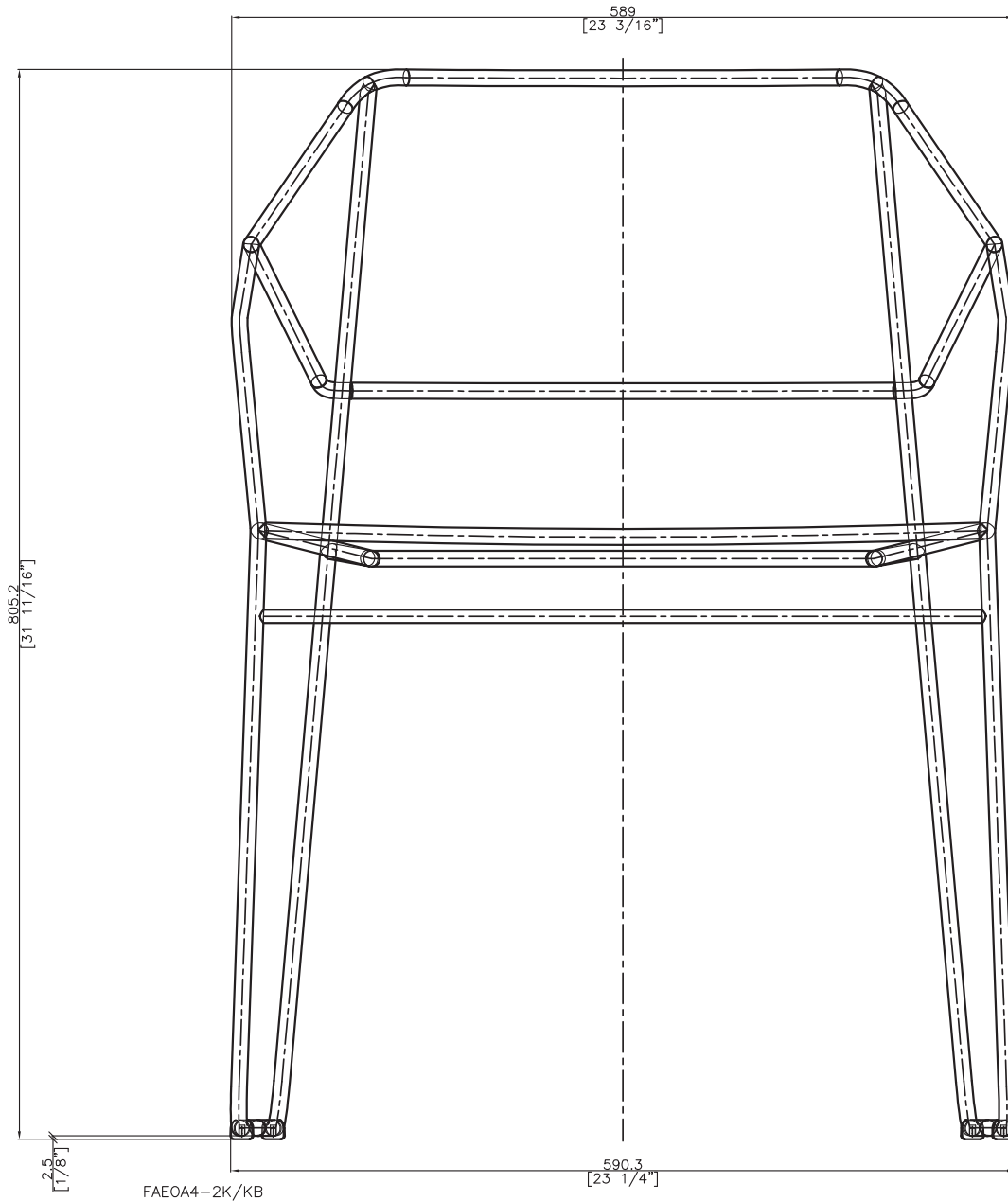

FRONT VIEW

EF

OASIQ

DWG.NO: FAEOA4-1

TITLE : FRONT VIEW

DIM EXT: 590.3x586x805.2 MM.

MATERIAL: SS304

DRAWN BY : Mr.Khanti

FINISH DATE : 25-07-13
 BEGIN DATE : 9-01-13

KHAN
 KHAN

SCALE : 1:1

P. 4

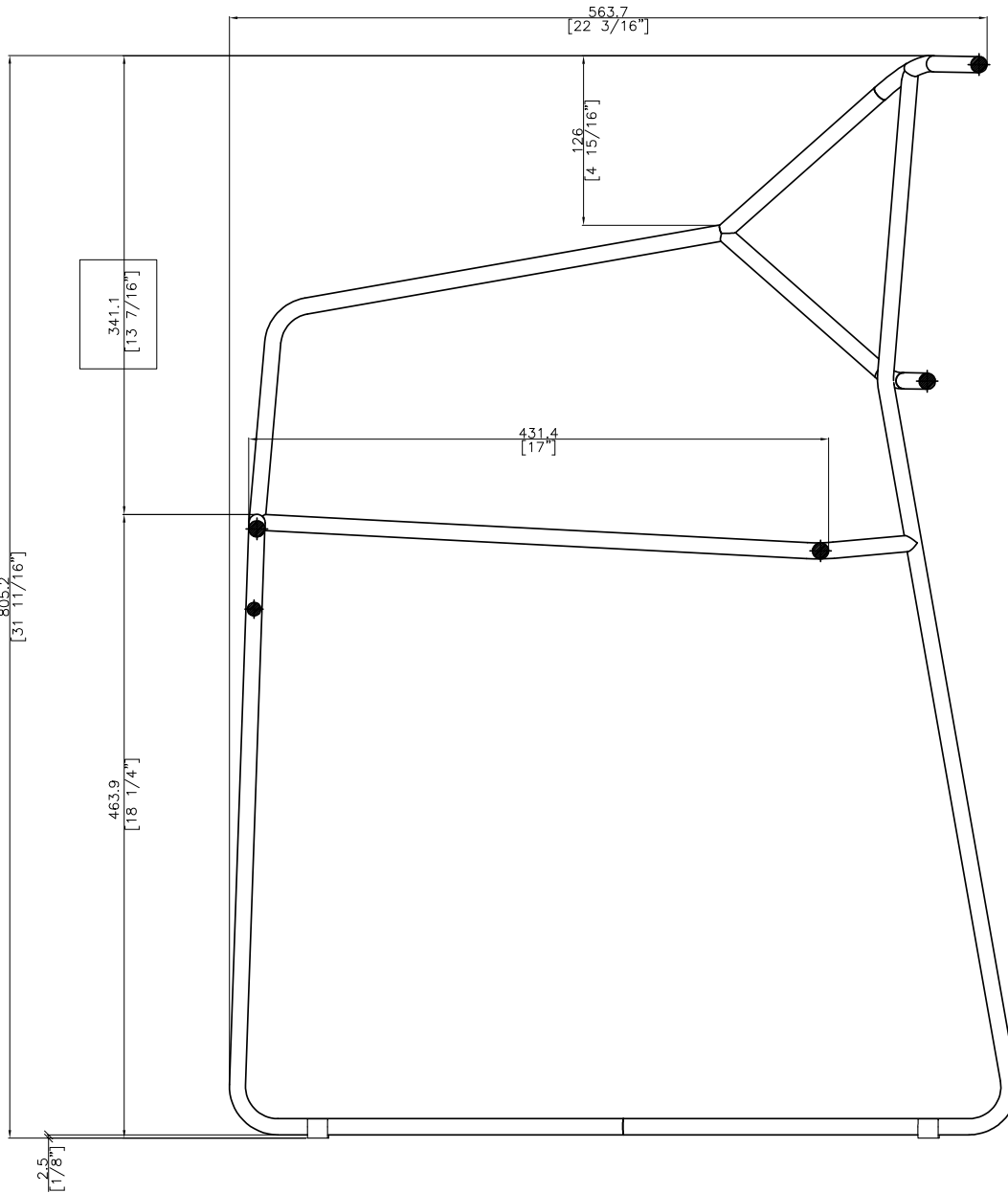

SIDE VIEW

ES

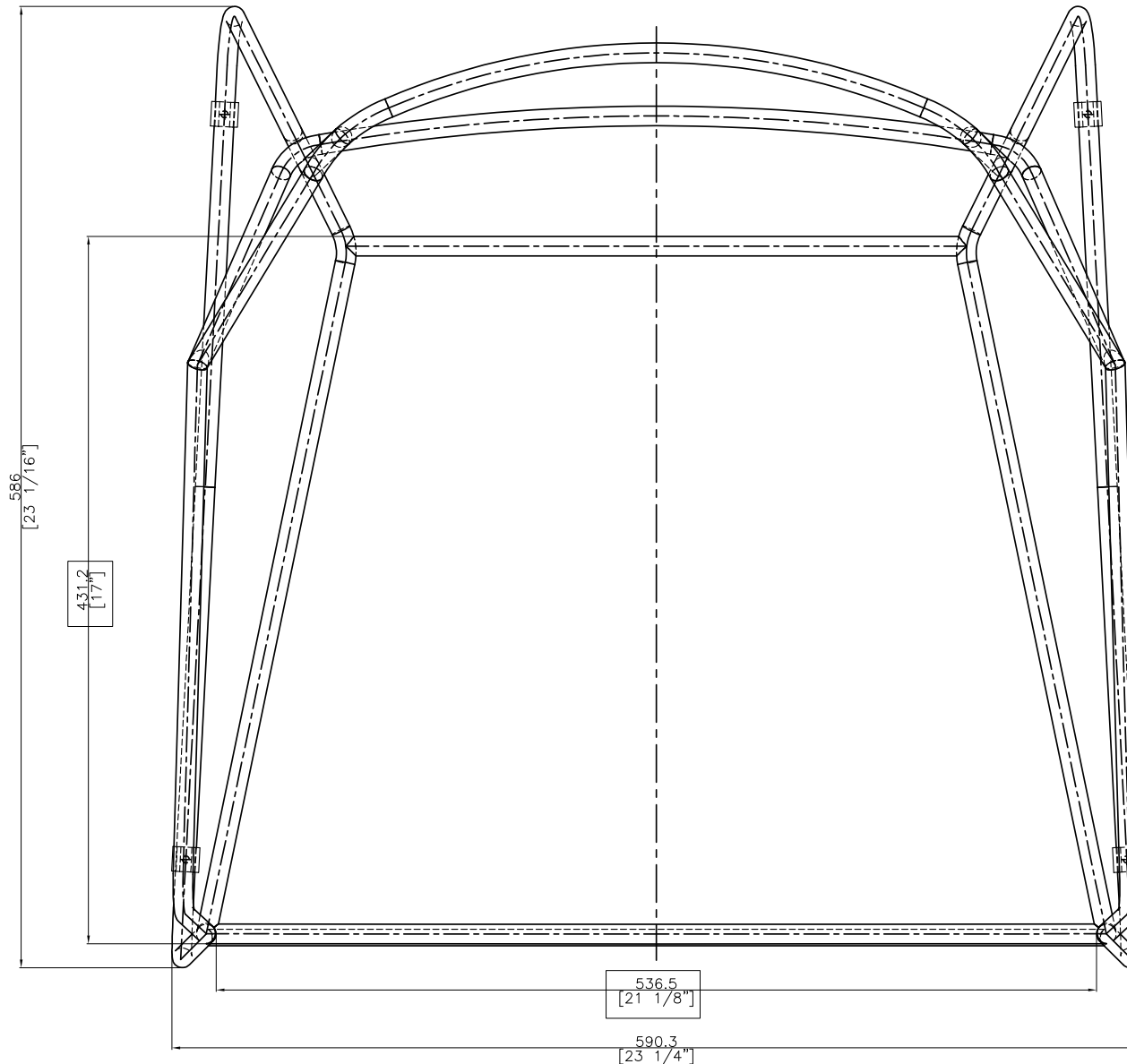

TOP VIEW

ET

OASIQ

DWG.NO: FAE0A4-1

TITLE : TOP VIEW

DIM EXT: 590.3x586x805.2 MM.

MATERIAL: SS304

DRAWN BY : Mr.Khanti

FINISH DATE : 11-10-13
 BEGIN DATE : 9-01-13

KHAN
 KHAN

SCALE : 1:1

P. 3