

ASSEMBLY INSTRUCTIONS

HOUSE LOFT BED WITH SLIDE

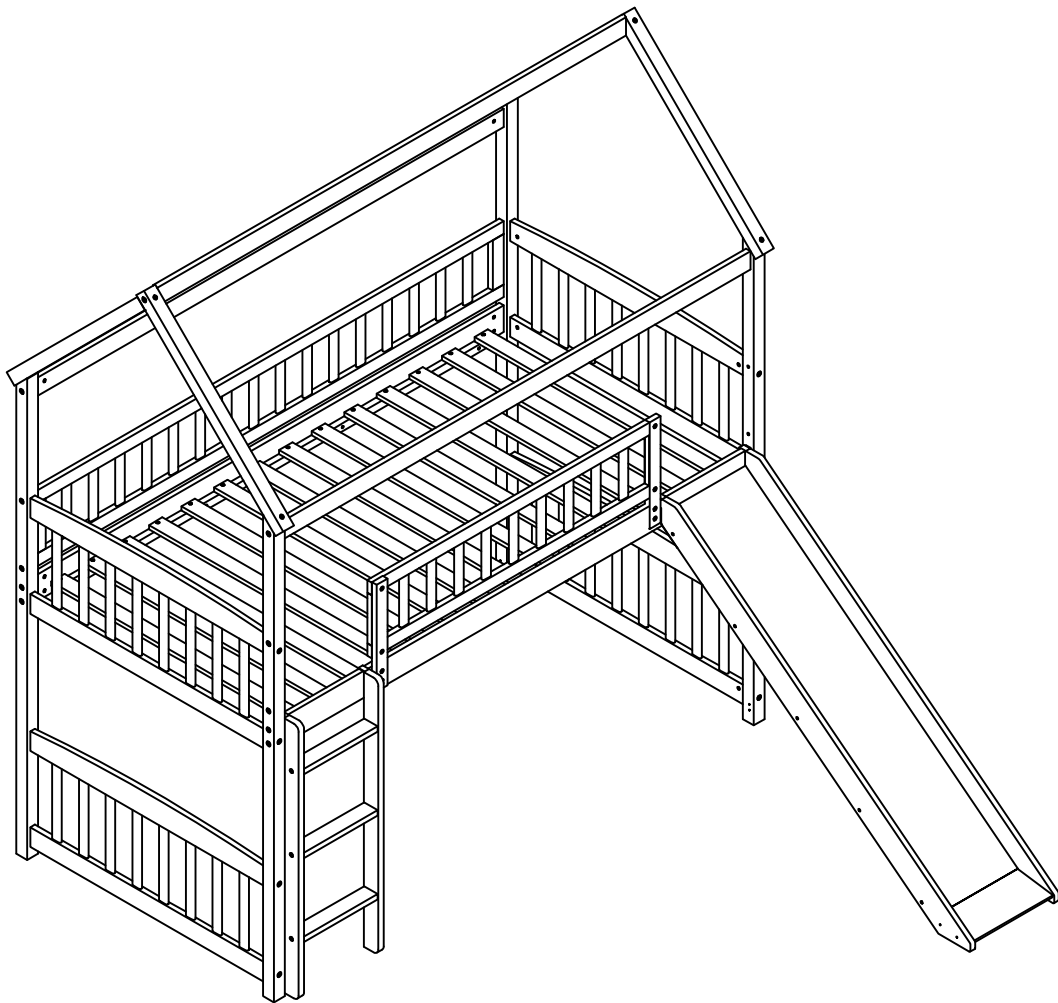



SAFETY WARNING



1. This bed is designed for use only mattress (es) meeting the following specifications on the upper bunk, and lower bunk:

Upper bunk (Bunk bed and tribed included)

Bed type	Length	Width	Thickness
Twin Standard	74"-75"	38 1/2"	6"

Lower bunk

Bed type	Length	Width	Thickness
Twin Standard	74"-75"	38 1/2"	8"

2. Replacement parts, including additional guardrails, maybe obtained from any of our
dealers
3. Follow the information on the warnings appearing on the upper bunk bed end structure and on the carton. Do not remove warning label from bed.
4. Always use the recommended size mattresses or mattress supports, or both, to help prevent the likelihood of entrapment or falls.
5. Surface of mattress must be at least 5" (127mm) below the upper edge of guardrails.
6. Do not allow children under 6 years of age to use the upper bunk.
7. Periodically check and ensure that the guardrail, ladder, and other components are in their proper position, free from damage, and that all connectors are tight.
8. Do not allow horseplay on or under the bed and prohibit jumping on the bed.
9. Always use the ladder for entering and leaving the upper bunk.
10. Do not use substitute part. Contact the manufacture or dealer for replacement part.
11. Use of a night light may provide added safety precaution for a child using the upper bunk.
12. Always use guardrails on both long sides of the upper bunk. If the bunk bed will be placed next to the wall, the guardrail that runs the full length of the bed should be placed against the wall to prevent entrapment between the bed and wall.
13. The use of water or sleep flotation mattresses is prohibited.
14. STRANGULATION HAZARD - Never attach or hang items to any part of the bunk bed that are not designed for use with the bed; for example, but not limited to, hook, belts and jump ropes.
15. Keep these instruction for future reference.
16. Prohibit more than one person on upper bunk
17. We recommend assembling your bunk bed on the shipping carton to protect your floor or carpet.
18. Be certain all staples are out of the box before beginning assembly on the shipping carton.



SAFETY WARNING







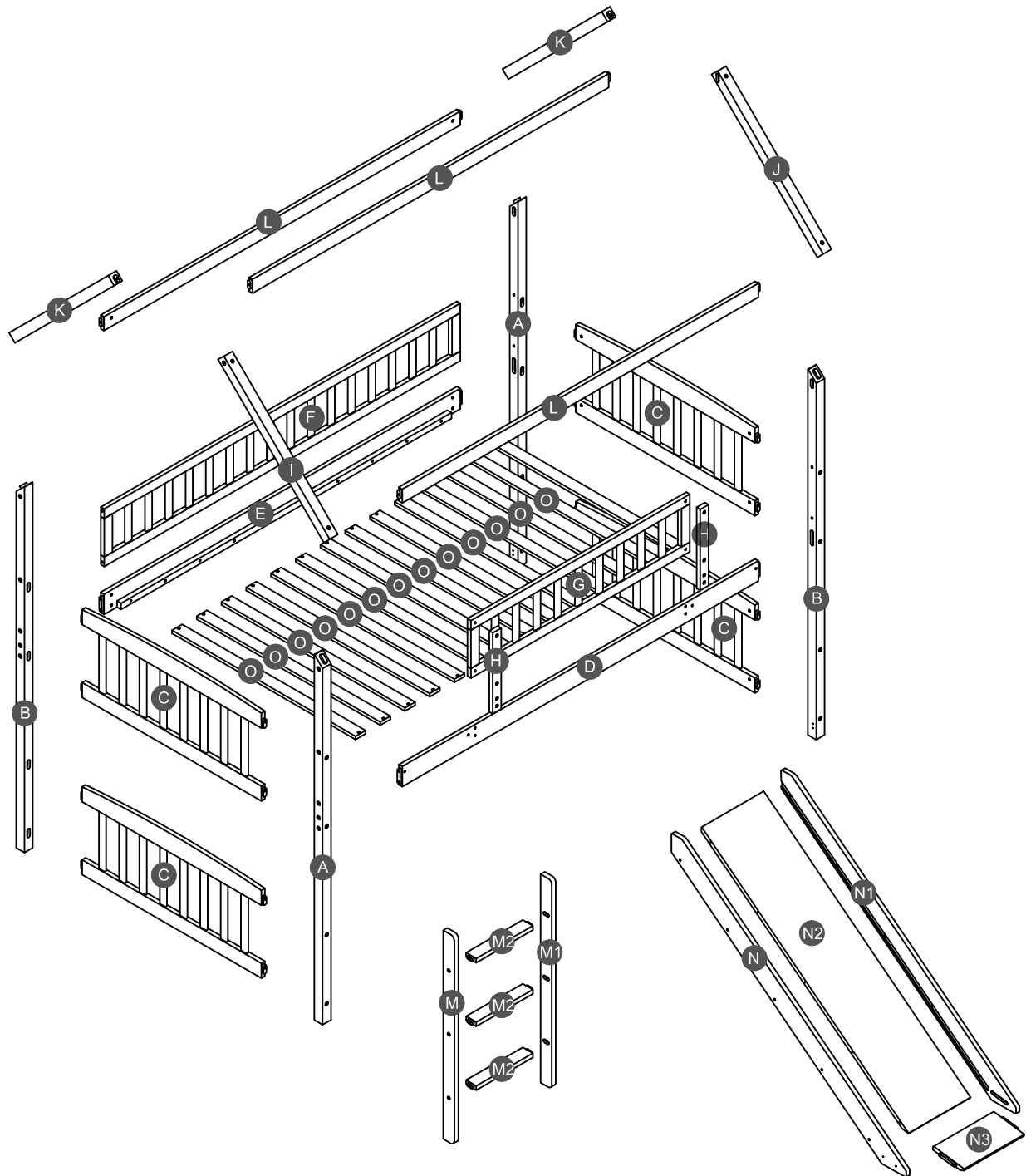



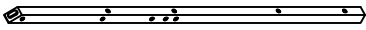
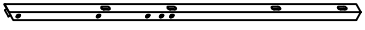

1. At the beginning :
 - Tighten all hardware.
 - Check metal parts for rust. If found, sand and repaint using a non-lead-based paint meeting the requirements of 16 CFR 1303.
 - Check all wood members for deterioration and splinters. Sand down splinters and replace deteriorating wood members.
 - Rake and check depth of loose fill protective surfacing materials to prevent compaction and to maintain appropriate depth. Replace as necessary.
2. Twice a month :
 - Tighten all hardware.
 - Rake and check depth of loose fill protective surfacing materials to prevent compaction and to maintain appropriate depth. Replace as necessary.
3. Owners shall be responsible for maintaining the legibility of the warning labels.
4. Disposal Instructions
 - There shall be instructions advising the owner to disassemble and dispose of the playground equipment in such a way that no unreasonable hazards will exist at the time the playground equipment is discarded.
5. The instruction shall also include the information found in Section 4 of the United States Consumer Product Safety Commission's (USCPSC) Outdoor Home Playground Safety Handbook or specific surfacing guidelines for the product consistent with the USCPSC Handbook. A copy of this section may be found in Appendix X2.
6. Observing the following statements and warnings reduces the like lihood of serious or fatal injury.
7. Specifying the number and weight of occupants that may safely use the equipment singly or simultaneously.
8. Recommending on-site adult supervision for children of all ages.
9. Warning the owner to instruct children not to use the equipment in a manner other than intended.
10. Warning the owner to instruct children not to get off equipment while it is in motion.
11. Warning the owner to allow children to wear inappropriate items, such as but not limited to, loose fitting clothing, hood and neck drawstrings, scarves, cord-connected items, capes and ponchos. These items can cause death by strangulation.
12. Warning the owner to instruct children not to climb when the equipment is wet.
13. Warning the owner to instruct children not to attach items to the playground equipment that are not specifically designed for use with the equipment, such as, but not limited to, jump ropes, clothesline, pet leashes, cables and chain as they may cause a strangulation hazard.
14. Warning the owner to instruct children to remove their bike or other sports helmet before playing on the playground equipment.
15. Warning the owner to dress children with well-fitting and full foot enclosing footwear. Examples of inappropriate footwear are clogs, flip flops, and sandals.
16. Place the equipment on level ground, not less than 6 ft (1.8 m) from any structure or obstruction such as a fence, garage, house, overhanging branches, laundry lines, or electrical wires.
17. Do not install home playground equipment over concrete, asphalt, packed earth, grass, carpet, or any other hard surface. A fall onto a hard surface can result in serious injury or death to the equipment user
18. To prevent serious injury, cautionary statements shall be included which warn that children must not use the equipment until properly installed.

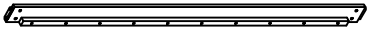
Detail View

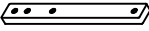

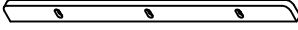
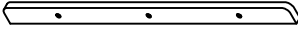
Part List

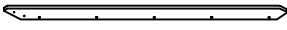
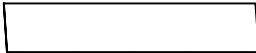





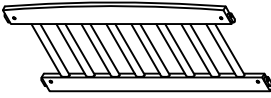
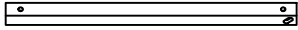
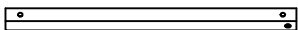
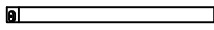
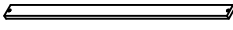



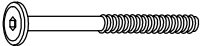
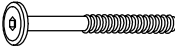

Hardware List WF295846

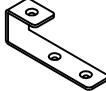
A  Leg (Left Front/Right Back) - 2pcs	B  Leg (Left Back/Right Front) - 2pcs	D  Side rail (front) - 1pc
E  Side rail (Back) - 1pc	F  Long guard rail - 1pc	G  Short guard rail - 1pc
H  Vertical guard rail - 2pcs	L  Upper horizontal bar - 3pcs	M  Left side ladder - 1pc
M1  Right side ladder - 1pc	M2  Step ladder - 3pcs	N  Left side ladder - 1pc
N1  Right side ladder - 1pc	N2  Slide panel - 1pc	N3  Slide base support - 1pc

WF295847

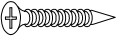
C  Frame HB & FB - 4pcs	I  Upper (Left Front) - 1pc	J  Upper (Right Front) - 1pc
K  Upper (Back) - 2pcs	O  Slats - 14pcs	

Hardware List

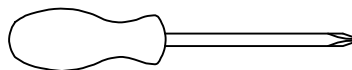

1  (Ø15)1/4"*100mm Hex-Head bolts (18pcs)	2  (Ø15)1/4"*80mm Hex-Head bolts (16pcs)	3  (Ø12)1/4"*60mm Hex-Head bolts (6pcs)
4  (Ø12)1/4"*35mm Hex-Head bolts (10pcs)	5  (1/4")4.5*58mm Allen key (1pc)	6  1/4"*15 (9.5mm) Horizontal-hole bolts (40pcs)
7  Ø4*30mm Wood screws (32pcs)	8  81*26*21*(2.5mm) Hooks (2pcs)	9  142*18*2mm Hooks (2pcs)
10  (Ø12)1/4"*65mm Hex-Head bolts (6pcs)	11  (Ø12)1/4"*50mm Hex-Head bolts (14pcs)	12  Ø4*19mm Wood screws (6pcs)
13  50*24*24*2mm Metal bracket (1pc)	14  ø3.5*15 mm Wood screws (4pcs)	15  Ø1/4"*14mm Flat washer (14pcs)
16  Ø13"*3mm Spring Washer (14pcs)		

ASSEMBLY TOOLS REQUIRED (NOT INCLUDED)



PLEASE BE CAREFUL DO NOT DAMAGE THE HOLE POSITION WHEN YOU USE POWER TOOLS !

STEP 1:

2 	6 	10 
8PCS	8PCS	1PC

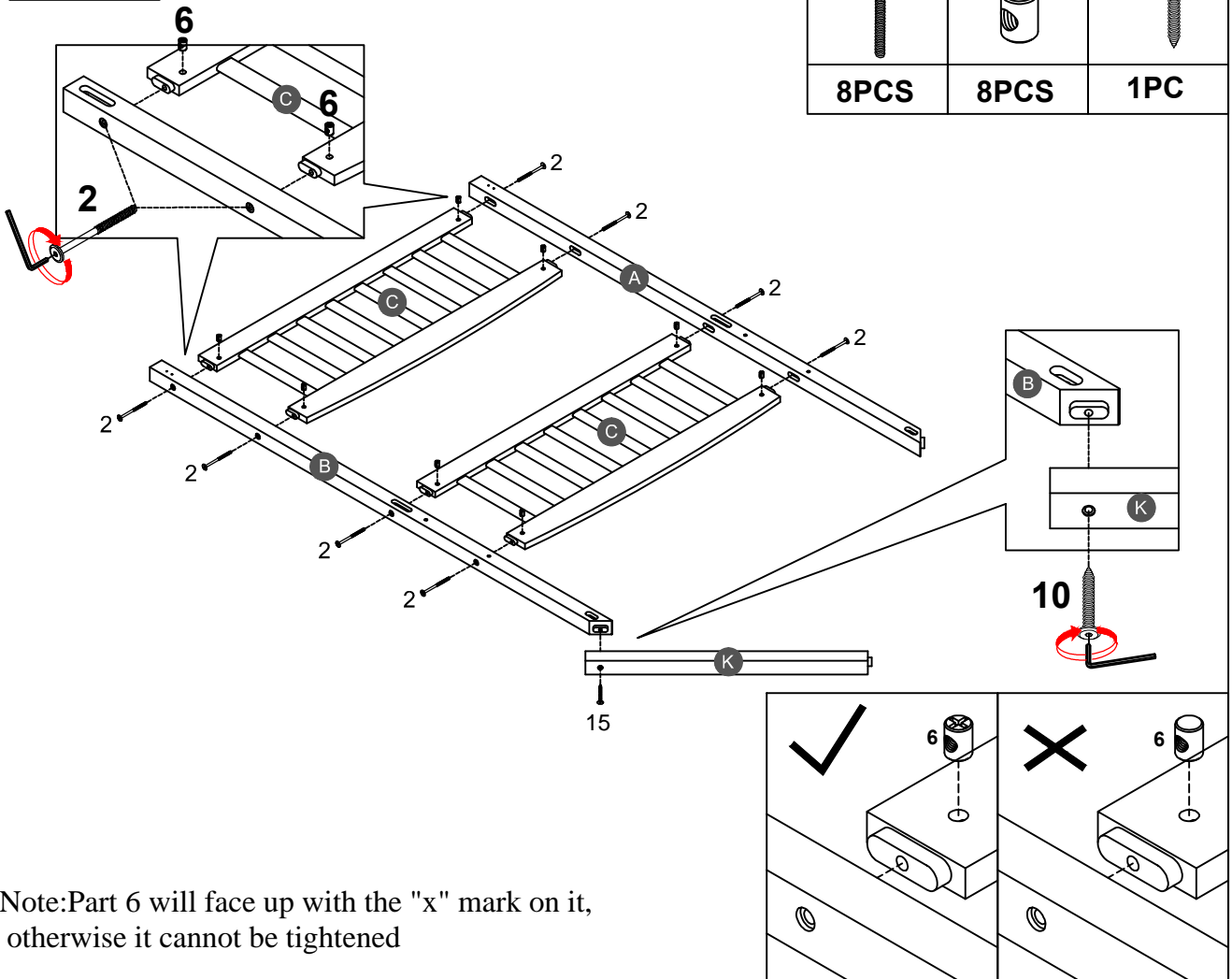

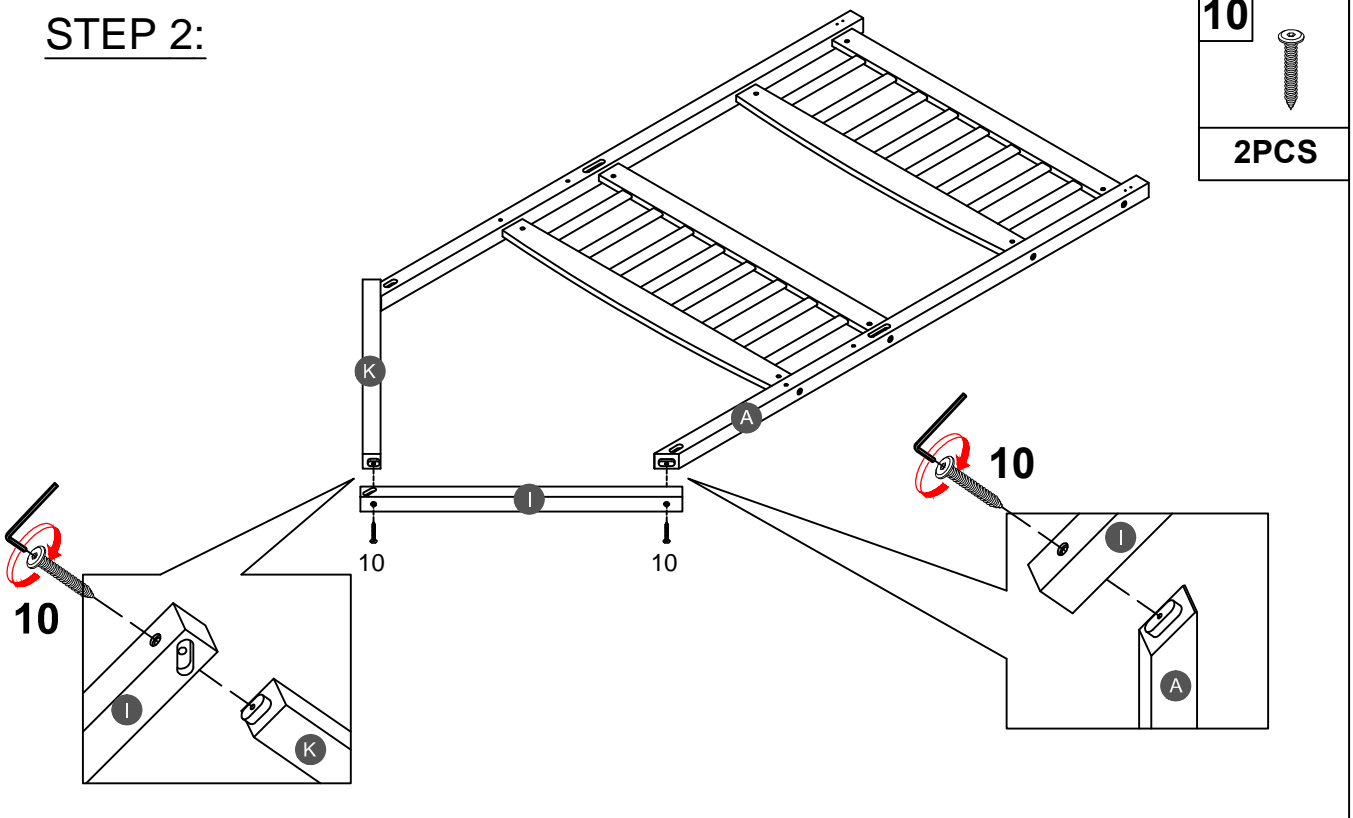

STEP 2:

10 
2PCS

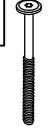

STEP 3:

2	6	10
		
8PCS	8PCS	1PC

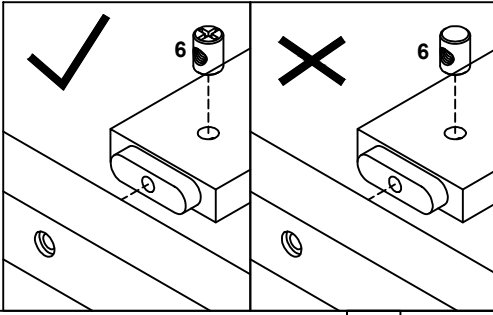
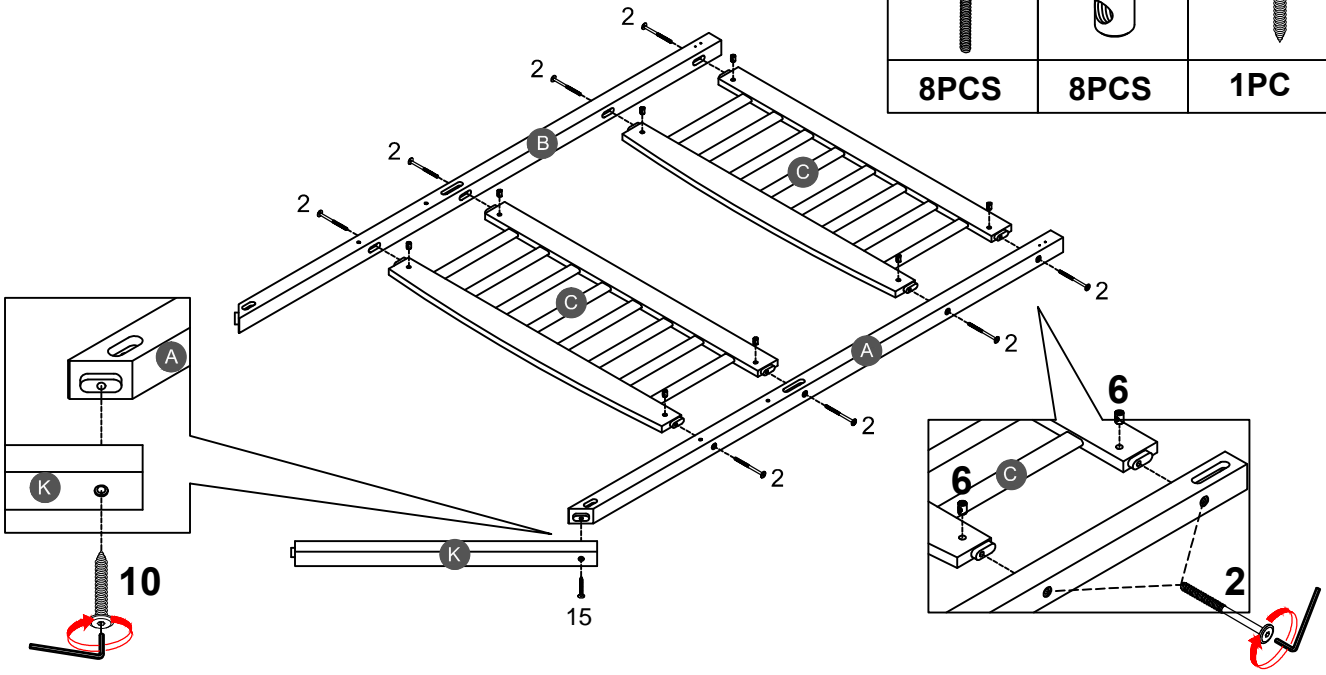

Note: Part 6 will face up with the "x" mark on it, otherwise it cannot be tightened

STEP 4:

10

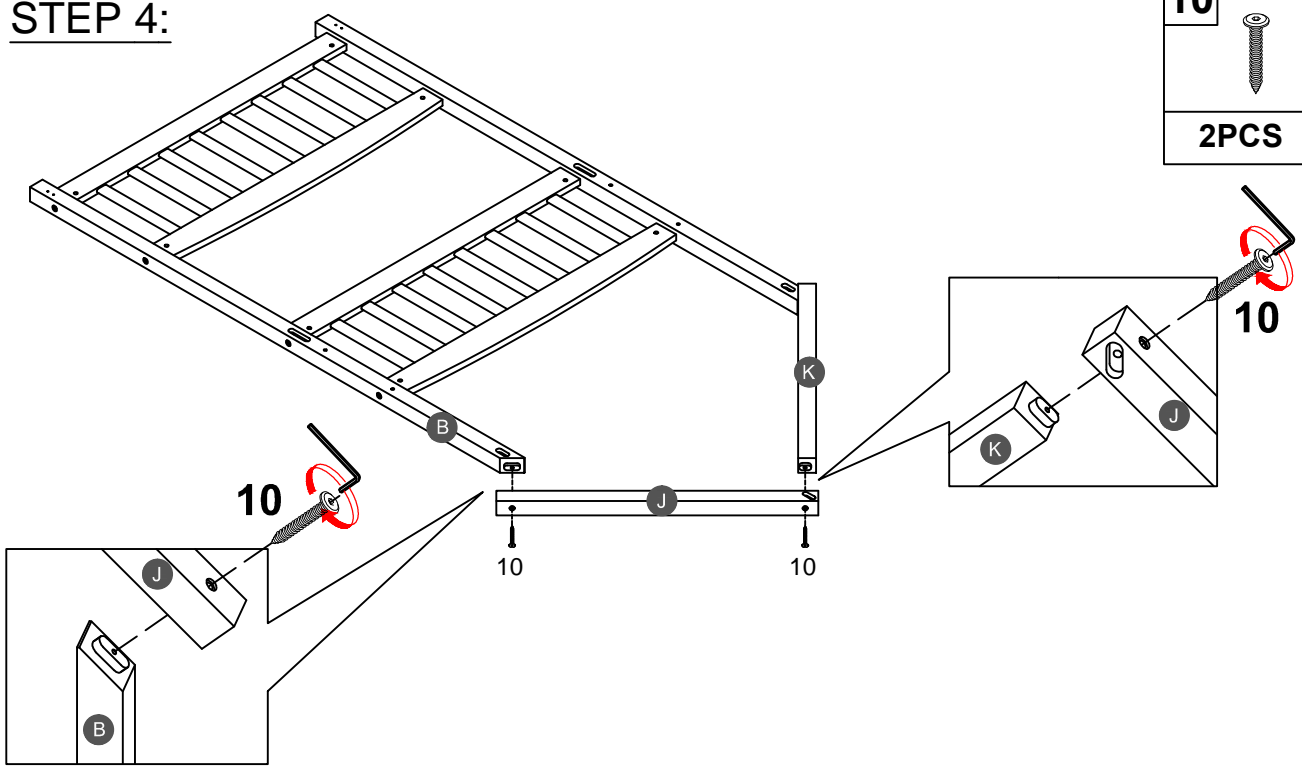
2PCS

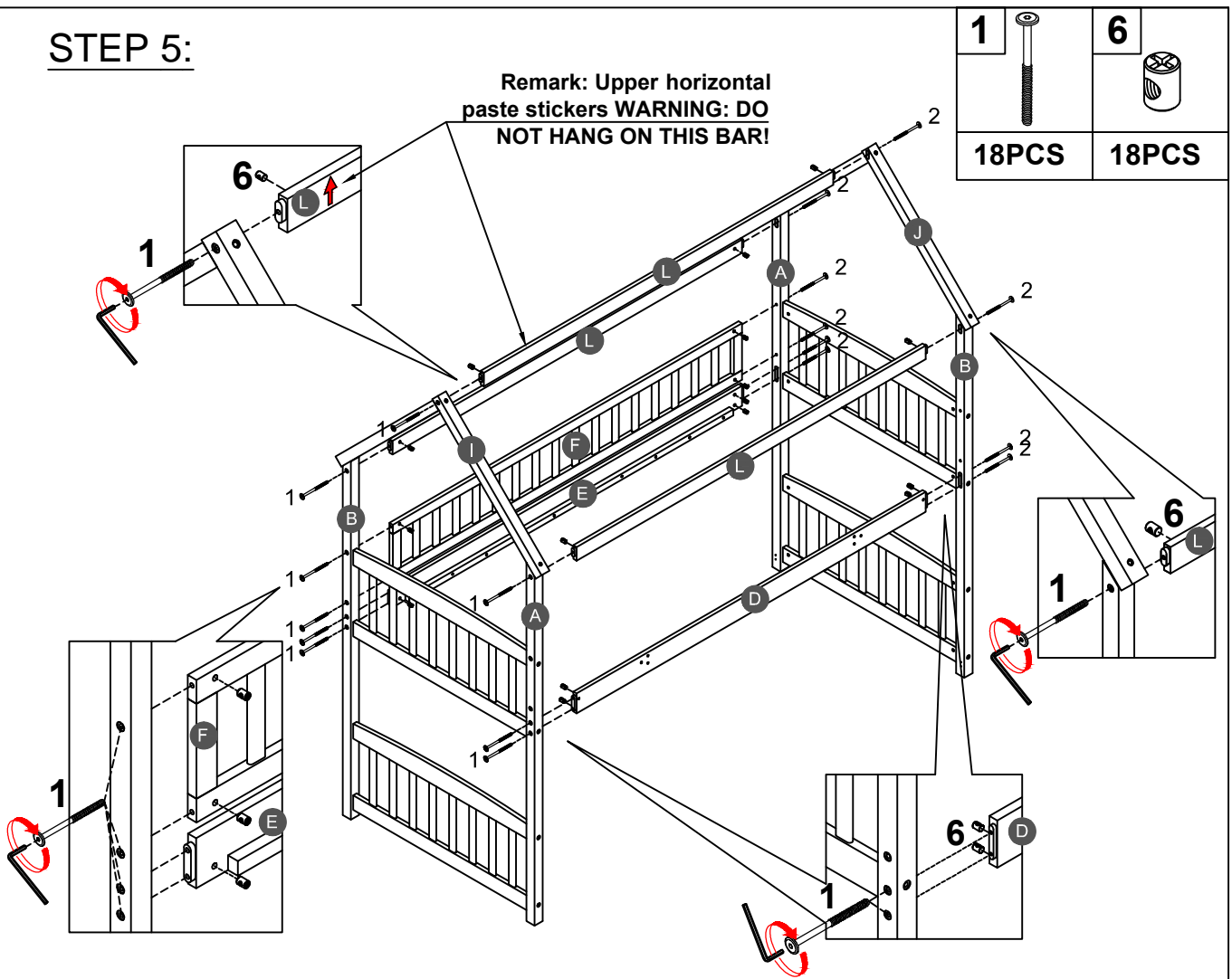

STEP 5:

Remark: Upper horizontal
paste stickers **WARNING: DO
NOT HANG ON THIS BAR!**



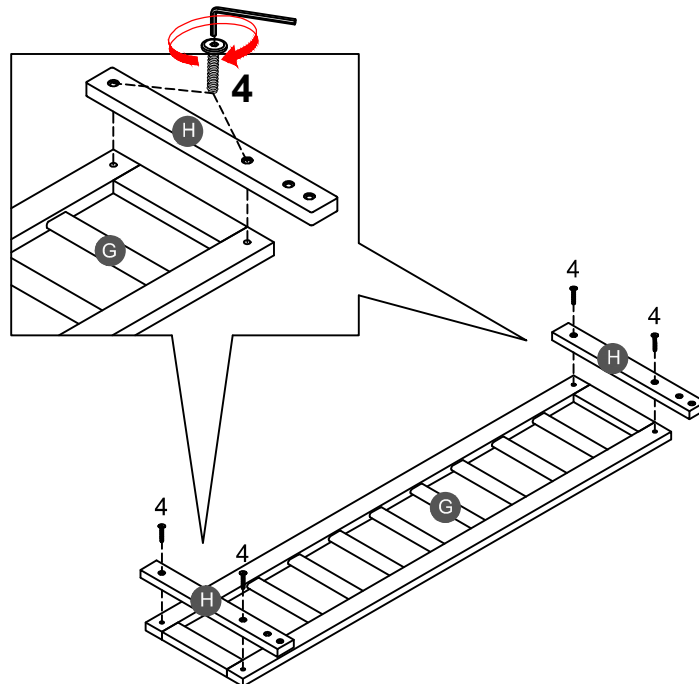

STEP 6:



4	
4PCS	

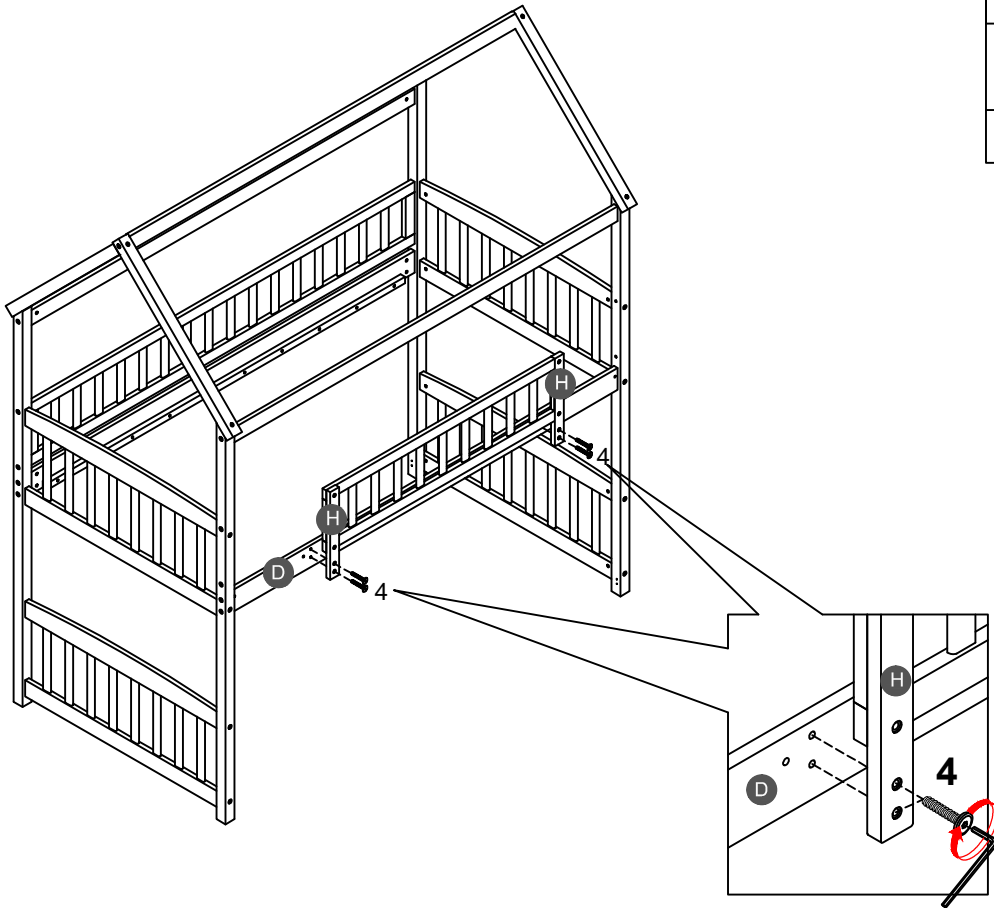





STEP 7:

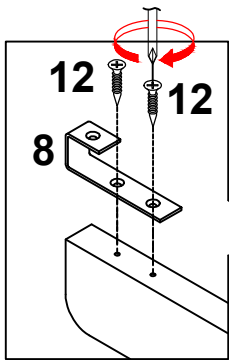

4	
4PCS	

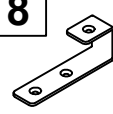
STEP 8:



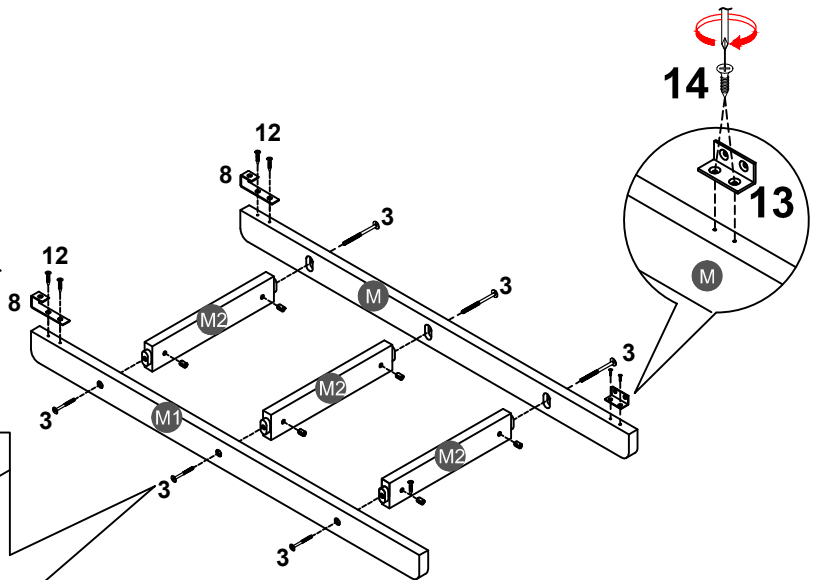
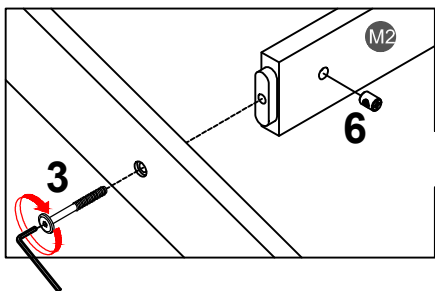

3		6		8		12		13		14	
6PCS	6PCS	2PCS		4PCS	1PC	2PCS					

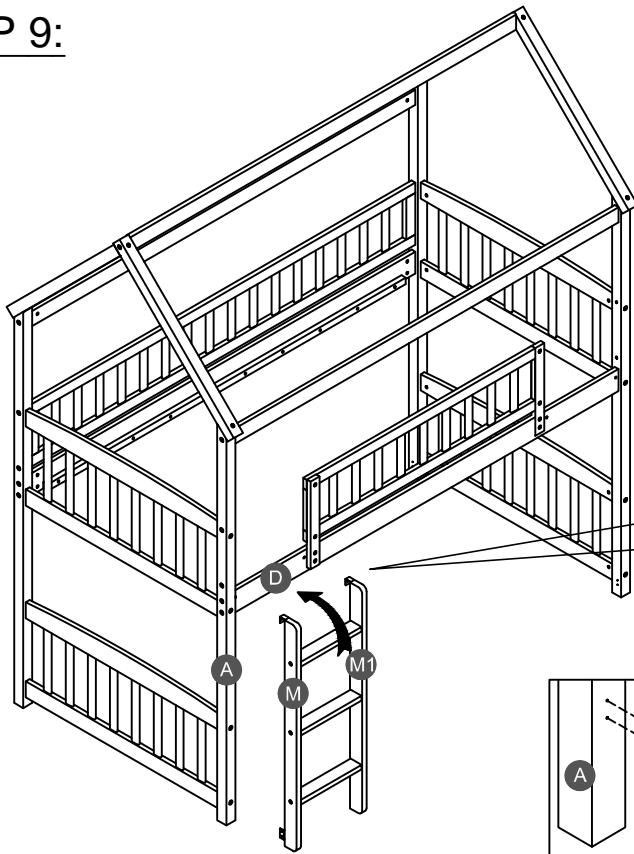

STEP 9:





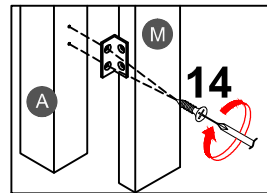
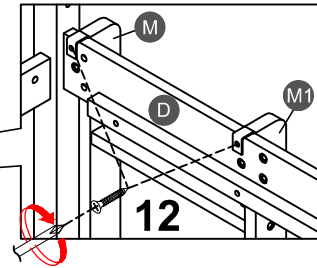

12 	14 
2PCS	2PCS

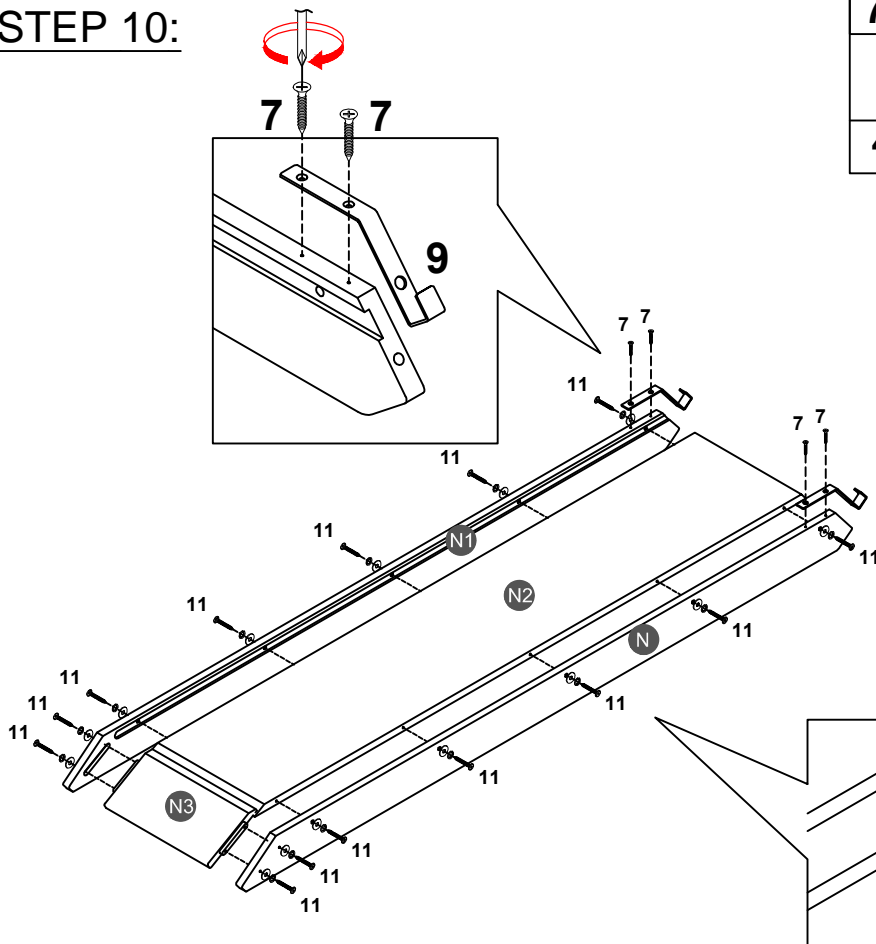

STEP 10:



7 	9 	11 
4PCS	2PCS	14PCS
	15 	16 
	14PCS	14PCS

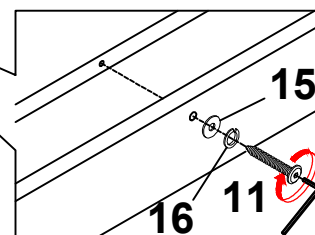

STEP 11:

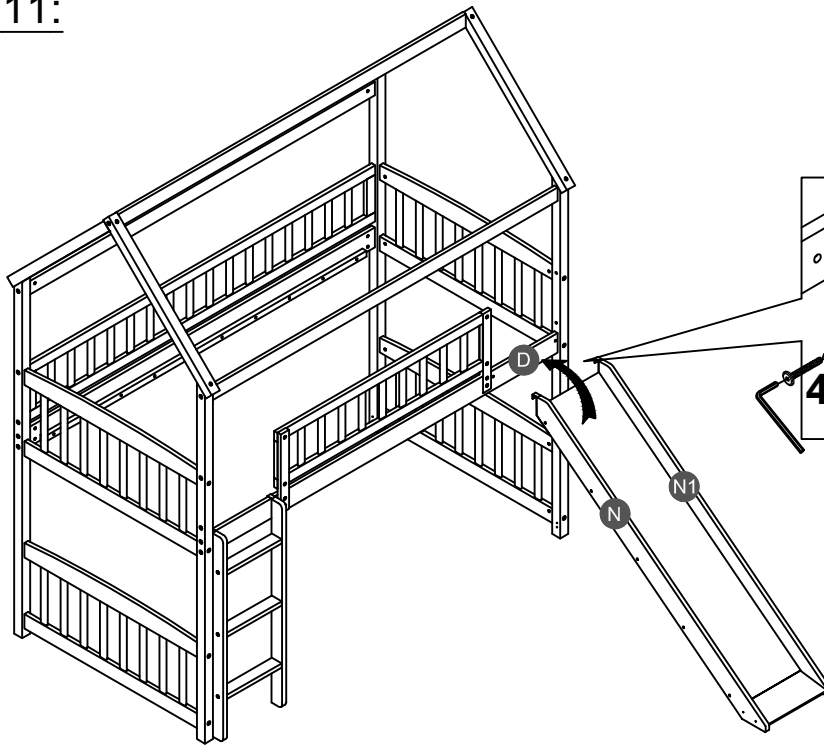

4



2PCS

STEP 12:

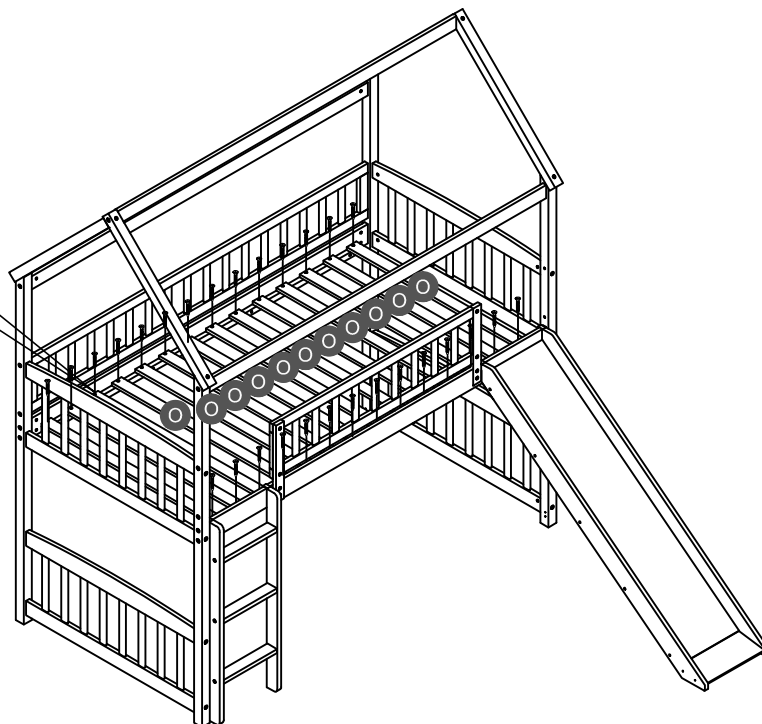
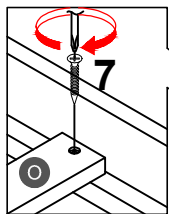

7



28PCS

3.1" 79mm 3.3" 84.5mm 2.4" 61mm

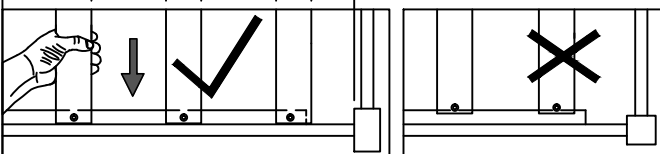

Note: Do not lock the screws of the bed slats to the outermost edge of the bed slats, you need to leave a certain space at the edges, otherwise it will cause the board to break. Do not lock the bed slats on the edge of the wood, please hold firmly before screwing, hold it in place with one hand, then lock the screw.