











ASSEMBLY INSTRUCTIONS

<p>Ax1</p>  <p>Backrest</p>	<p>Fx7</p>  <p>M8*55mm Screw</p>
<p>Sx1</p>  <p>Seat</p>	<p>Gx11</p>  <p>M8 Spring washer</p>
<p>Bx2</p>  <p>Front leg</p>	<p>Hx13</p>  <p>M8*22mm Flat washer</p>
<p>Cx2</p>  <p>Rear leg</p>	<p>Kx1</p>  <p>M8 Allen key</p>
<p>Dx4</p>  <p>Adjust cap</p>	<p>Lx1</p> 
<p>Ex4</p>  <p>M8*60mm Screw</p>	

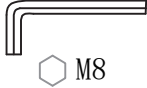
① The legs and screws and ring are inside of seat cushion. Pls unzip and open the seat.

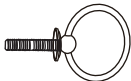

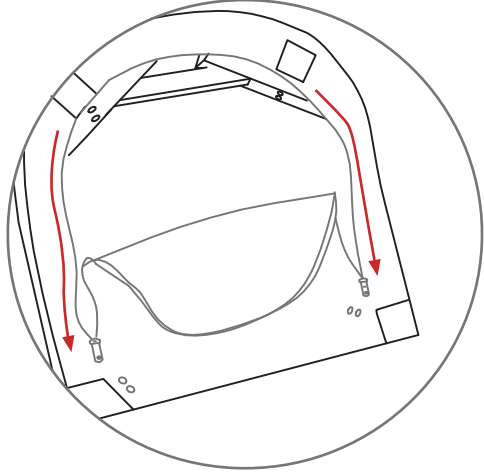
②

1. Pre-tighten the screw in the middle first: Put the Gx1 and Hx1 on the screw, insert them vertically into the hole by hand, keep the screw completely perpendicular to the nut, and tighten the screw by hand to about 10% tightness instead of allen key

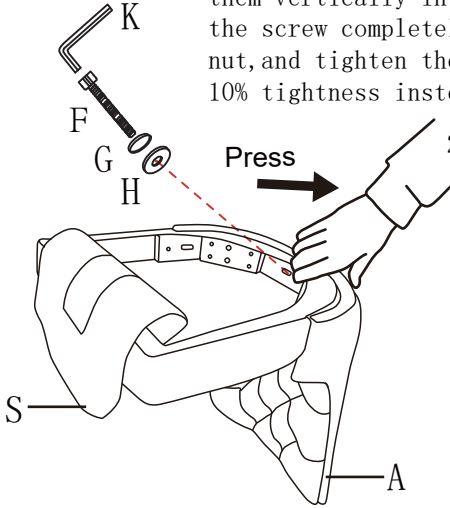

2. Then use an Allen key to further tighten the screw until it reaches about 70% tightness.

③

1. Install the screws on both sides: Put the Gx1 and Hx2 on the screw, insert them vertically into the hole by hand, keep the screw completely perpendicular to the nut, and tighten the screw by hand to about 10% tightness instead of allen key

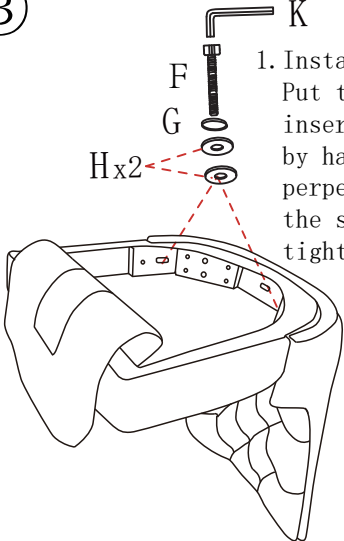

2. All steps insert screws vertically into the hole by hand firstly, then using allen key to 100%

④

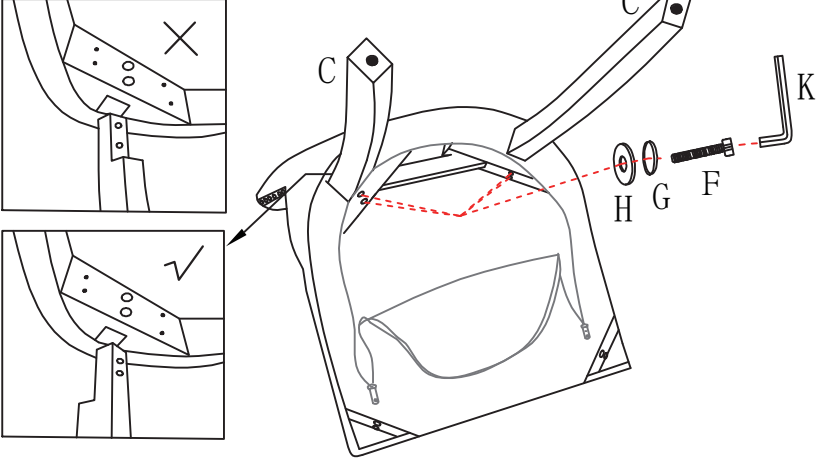

Tighten all the screws to 80% of maximum tightness

WARNING:

DO NOT STAND ON THE PRODUCT, DO NOT USE THIS PRODUCT AS A STEP LADDER.

DO NOT USE THIS PRODUCT UNLESS ALL BOLTS, SCREWS AND KNOBS ARE FIRMLY SECURED.

PLEASE DO NOT USE KNIFE TO OPEN ANY PARTS OF THE BOX OR PRODUCT.

ASSEMBLY INSTRUCTIONS

5

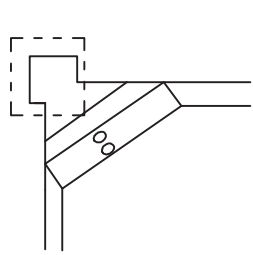

1. Put the front leg in the dotted box place, if you put it in the wrong place, it still can work, but the uneven force will cause the leg to break.
2. Tighten all the screws to 80% of maximum tightness

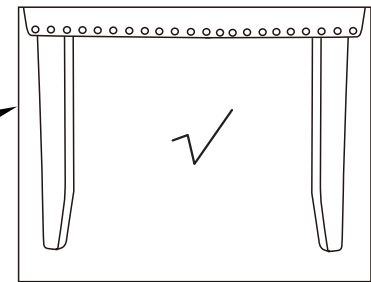
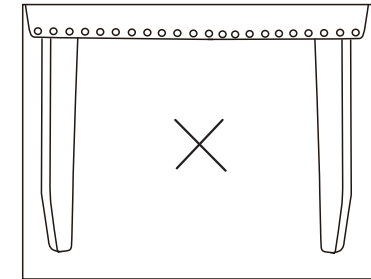
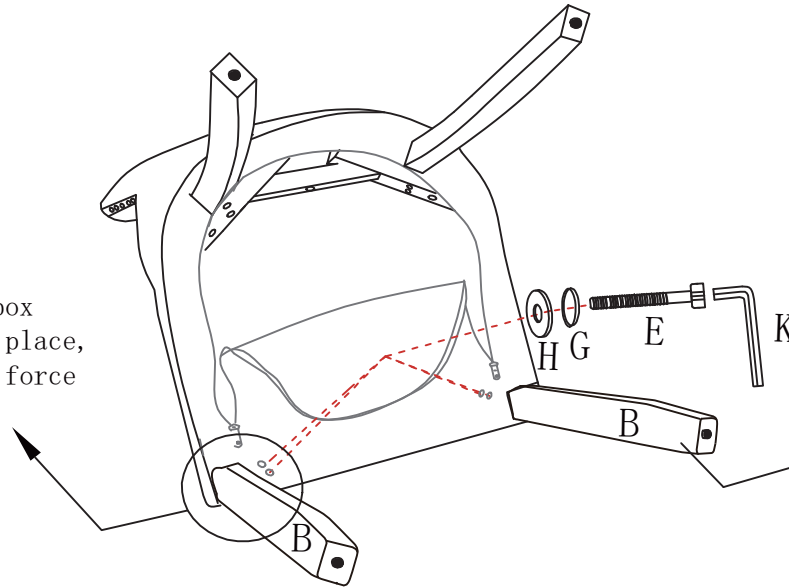

6

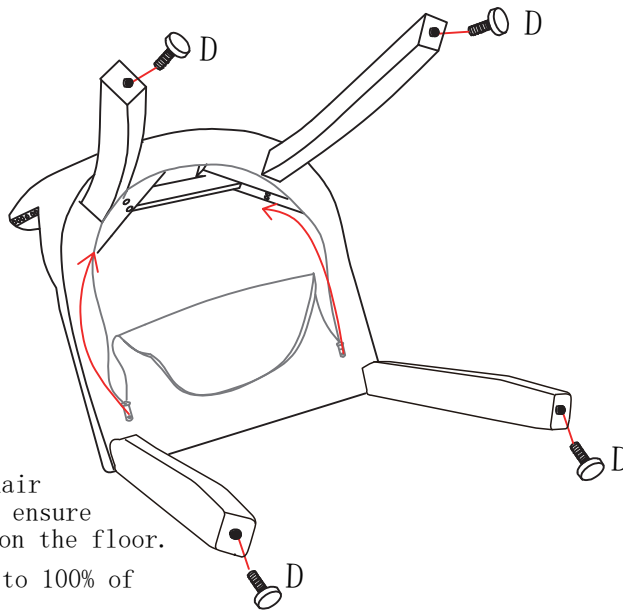

1. screw D into legs.
2. Carefully sit on the chair and make adjustments to ensure the legs are flat even on the floor.
3. Tighten all the screws to 100% of maximum tightness
4. Close the zipper of bottom Non-Woven fabric.

7

There are 4 small adjusters on the legs, ensure these are adjusted so the chair sits level.

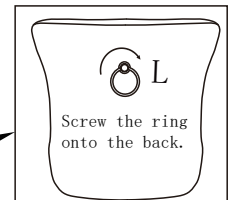
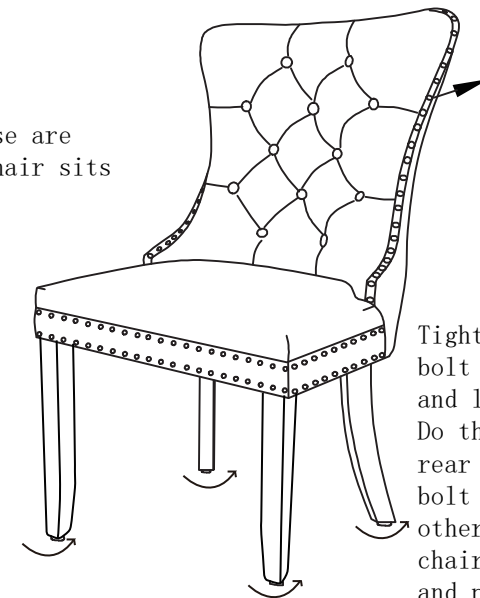

Tighten one adjustment bolt on the front leg and loosen the other. Do the same for the rear leg—tighten one bolt and loosen the other—to ensure the chair remains level and properly balanced.