

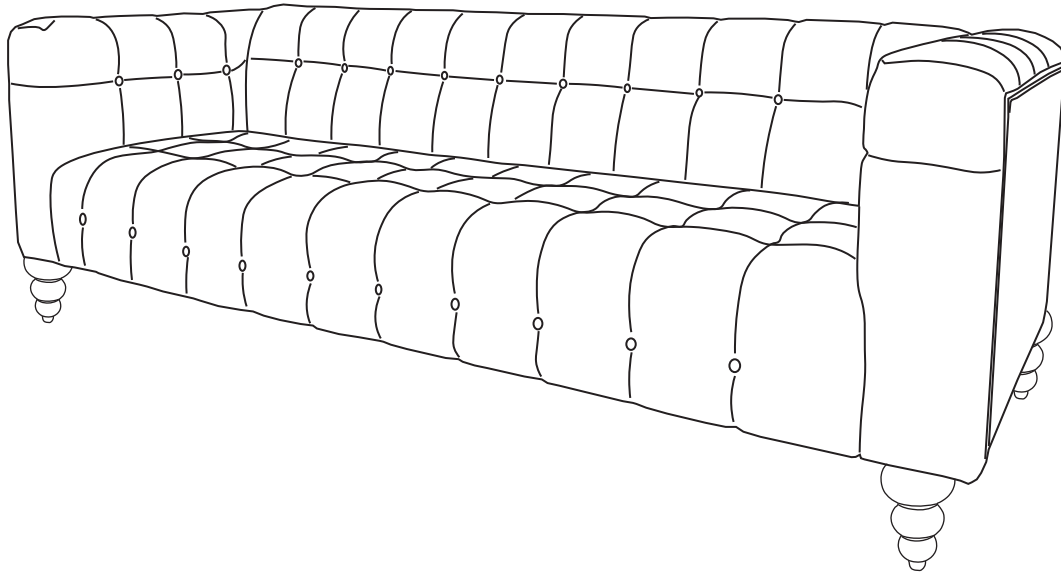



# ASSEMBLY INSTRUCTIONS

WF306136/137

3 SEATER SOFA

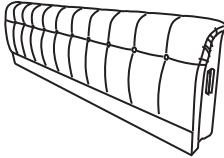
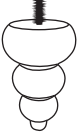
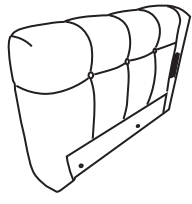

3 SEATER SOFA is packed in 2 cases

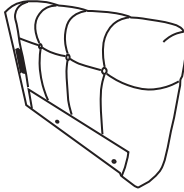
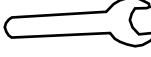
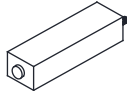
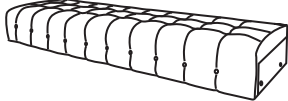
Carton	Disignation	Part	Hardware/Leg
1/2 WF306136	Backrest	#1 	 #A x 4pcs
	Left arm	#2 	 #B x 4pcs  #C x 4pcs  #D x 4pcs
	Right arm	#3 	 #E x 4pcs  #F x 1pc
2/2 WF306137	Seat	#4 	

# ASSEMBLY INSTRUCTIONS

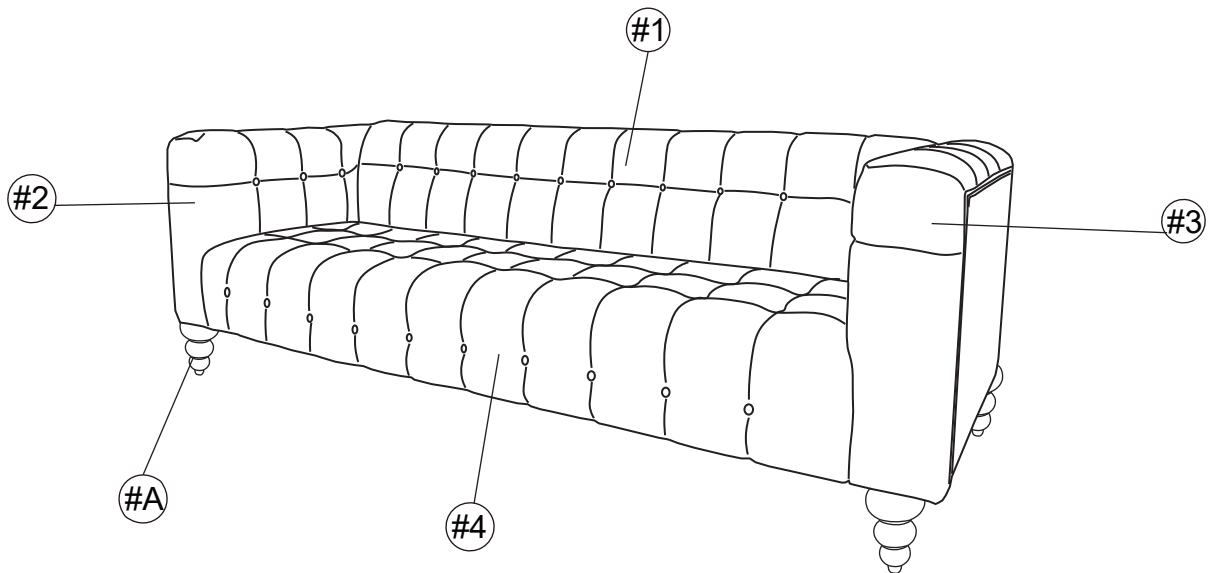

## PARTS

#1 1pc

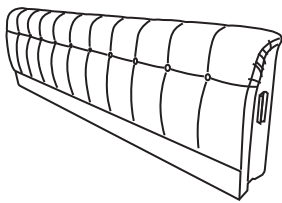

BACKREST

#2 2pcs

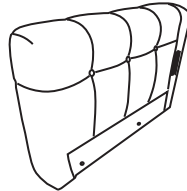

LEFT ARM

#3 1pc

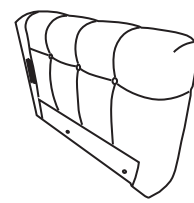

RIGHT ARM

#4 1pc

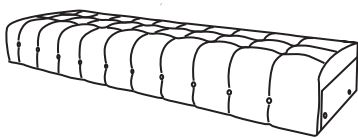

SEAT

## HARDWARE

#A 4 pcs



WOODEN LEG

#B 4 pcs



WHOLE TOOTH SCREW  
90mm L

#C 4 pcs



NUT

#D 4 pcs



FLAT WASHER  
22mm

#E 1 pc

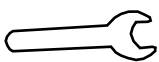

WRENCH

#F 1 pc

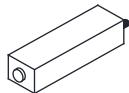

SUPPORT LEG  
30\*30\*155mm

# ASSEMBLY INSTRUCTIONS

## STEP1:

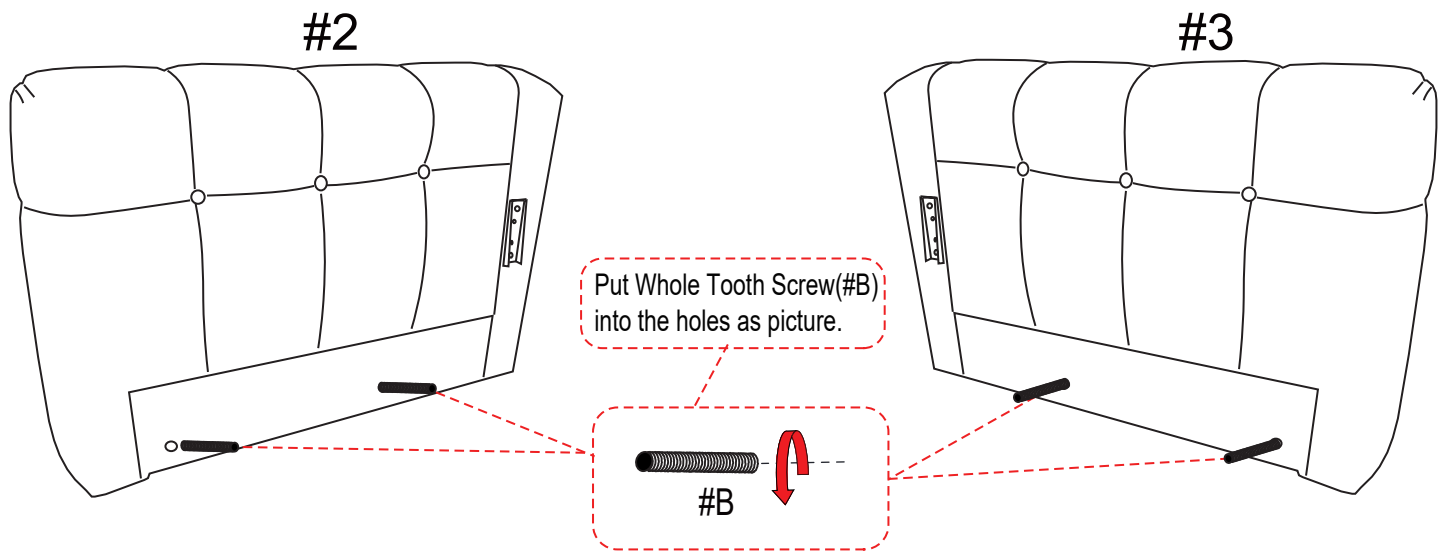

## STEP2:

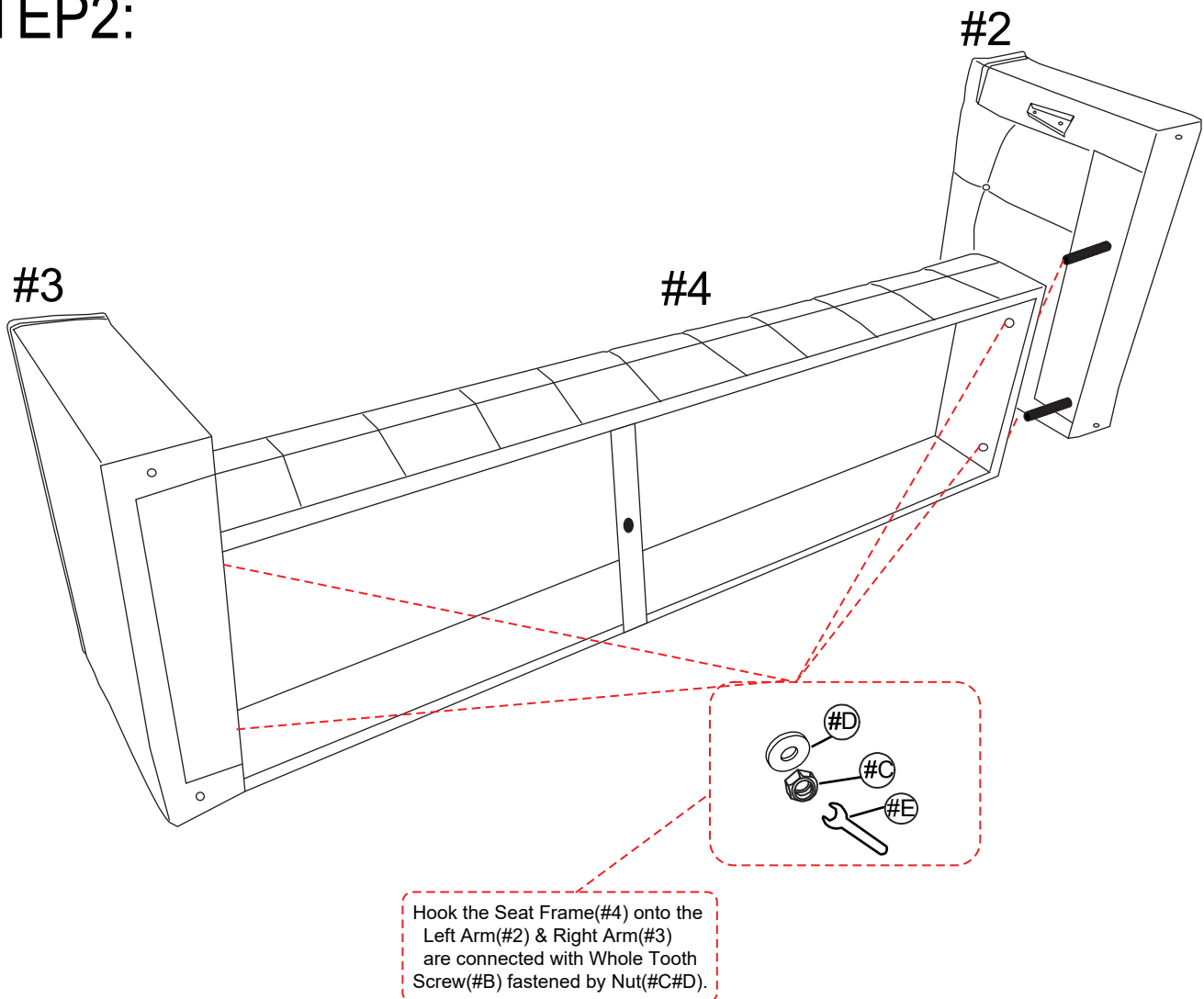

# ASSEMBLY INSTRUCTIONS

STEP3:

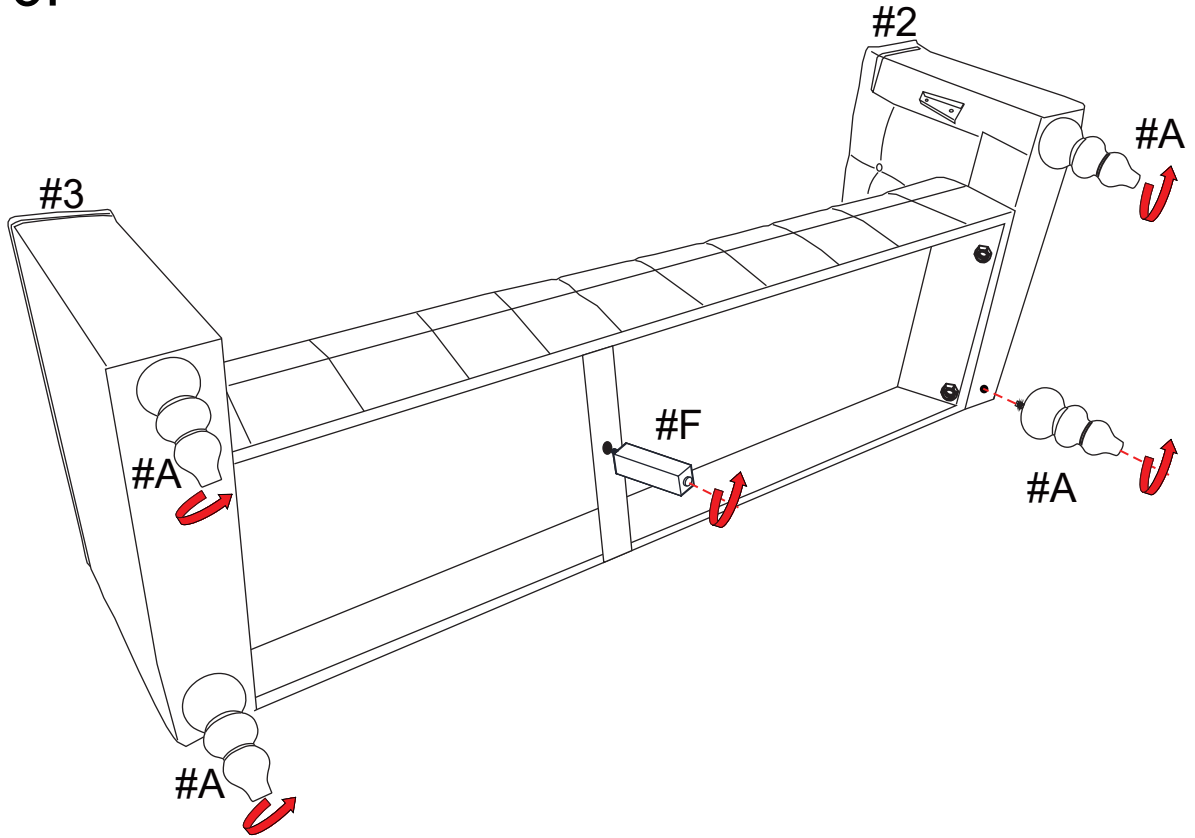

STEP4:

