

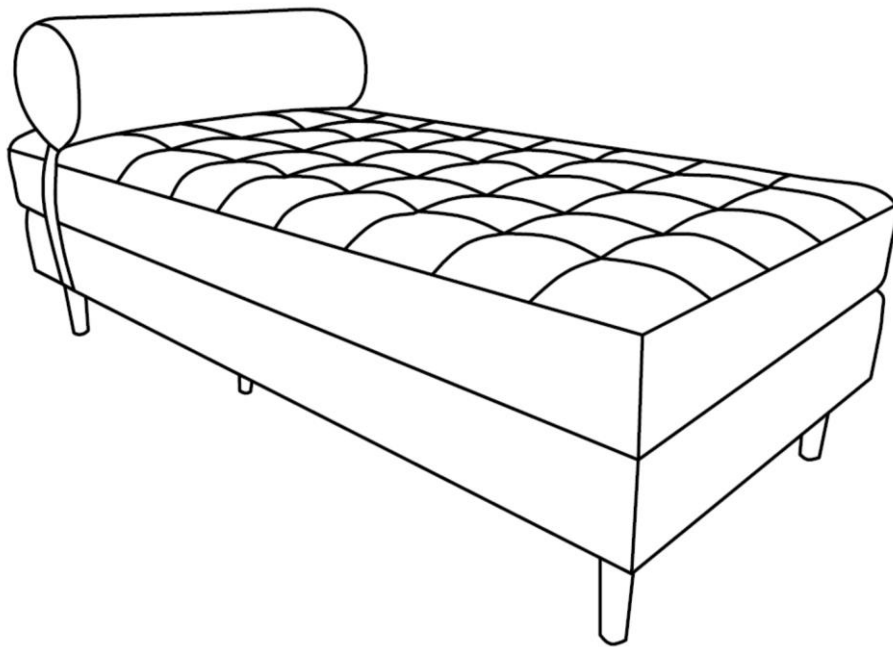

Assembly Instructions

Chaise

Caution: You must read this before you proceed.

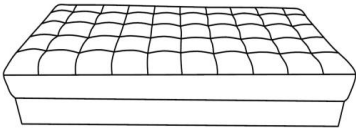

Parts List

Label	Picture	Description	Qty
A		Seat Frame	1
B		Wooden Legs	5

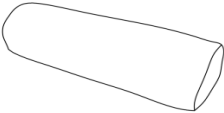
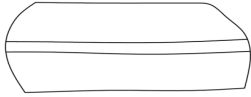
C		Pillow	1
D		Pillow Cover	1

Hardware

Label	Picture	Description	Qty
①		Washer Rings	9

Assembly Preparation

Before Beginning Assembly:

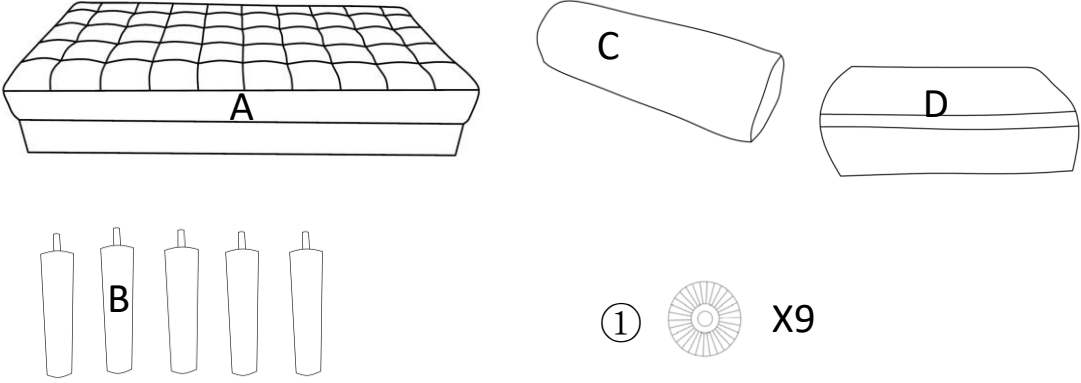

- Read instructions, cover to cover-



- Have 2 adults on hand for assembly-



- Do not assemble on flooring or carpet-



- Assemble on a clean non-marring surface (packing foam)-



- Save all packaging until finished-

Assembly Steps

Overview

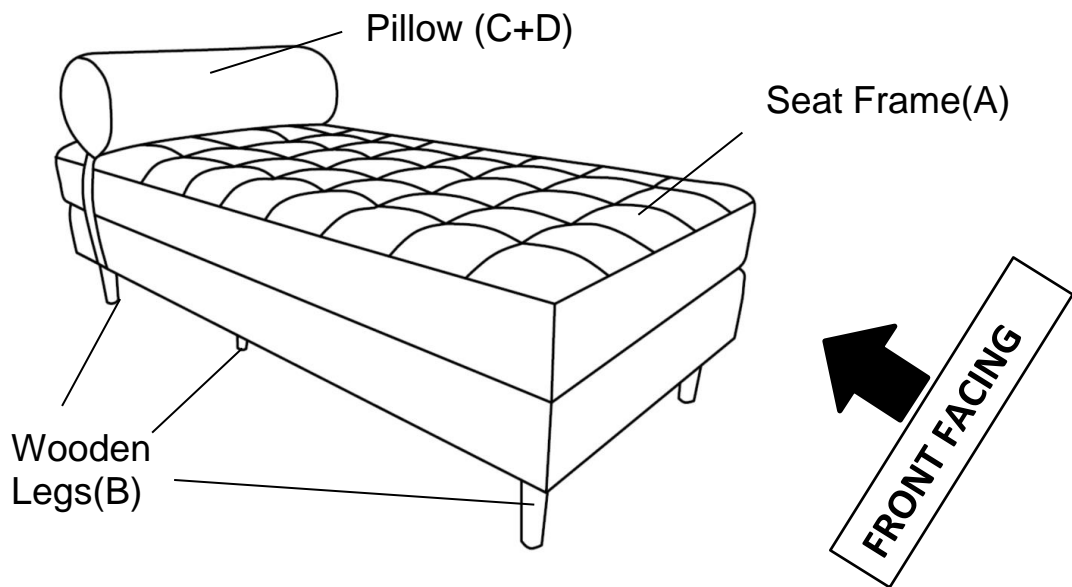

This Chaise has multiple parts and may require up to 30 minutes to assemble. To give you an overview of the Chaise parts, the above picture is to help you put the various parts into perspective. Please read through the instructions below to familiarise yourself with the parts and steps before assembly.

Step 1

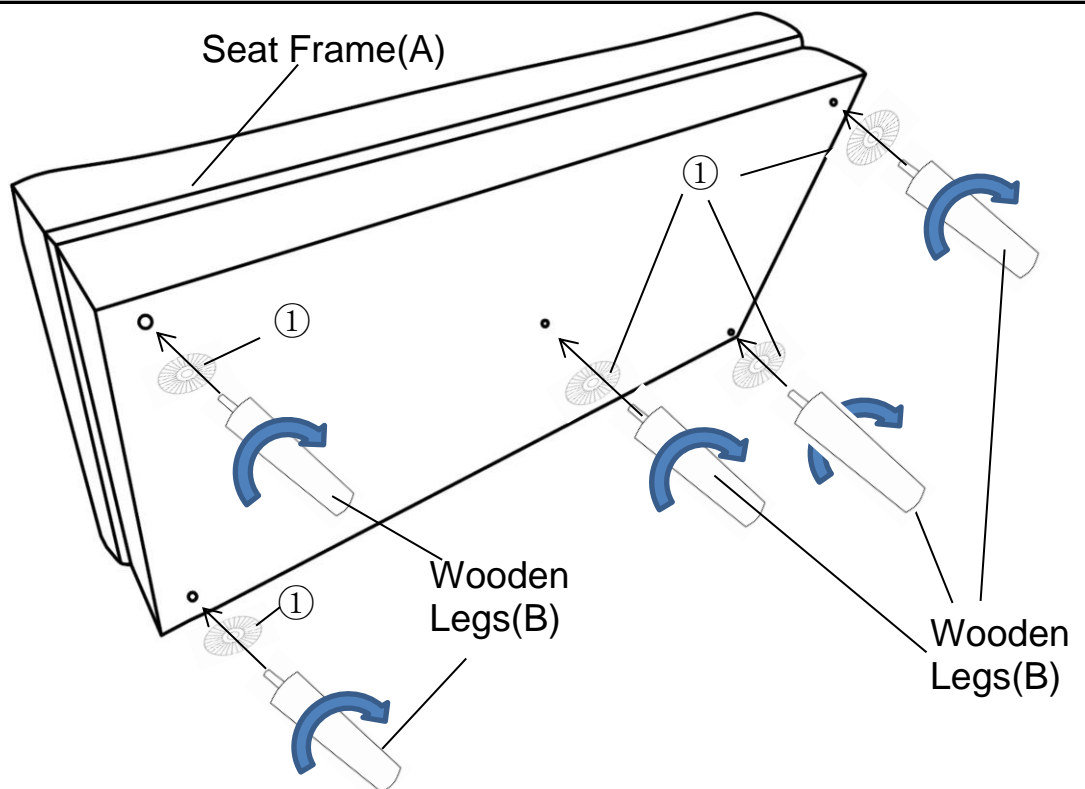

Tilt and lay the Chaise on its side onto a flat surface, Install the Wooden Legs(B) With Washer Rings(①) onto the bottom of the Seat Frame(A). Tighten by turning the Legs clockwise.

Note: The use of Washer Rings is OPTIONAL and are especially useful to help alleviate slight wobbleness. Some Legs may need more than one Washer .

Step 2

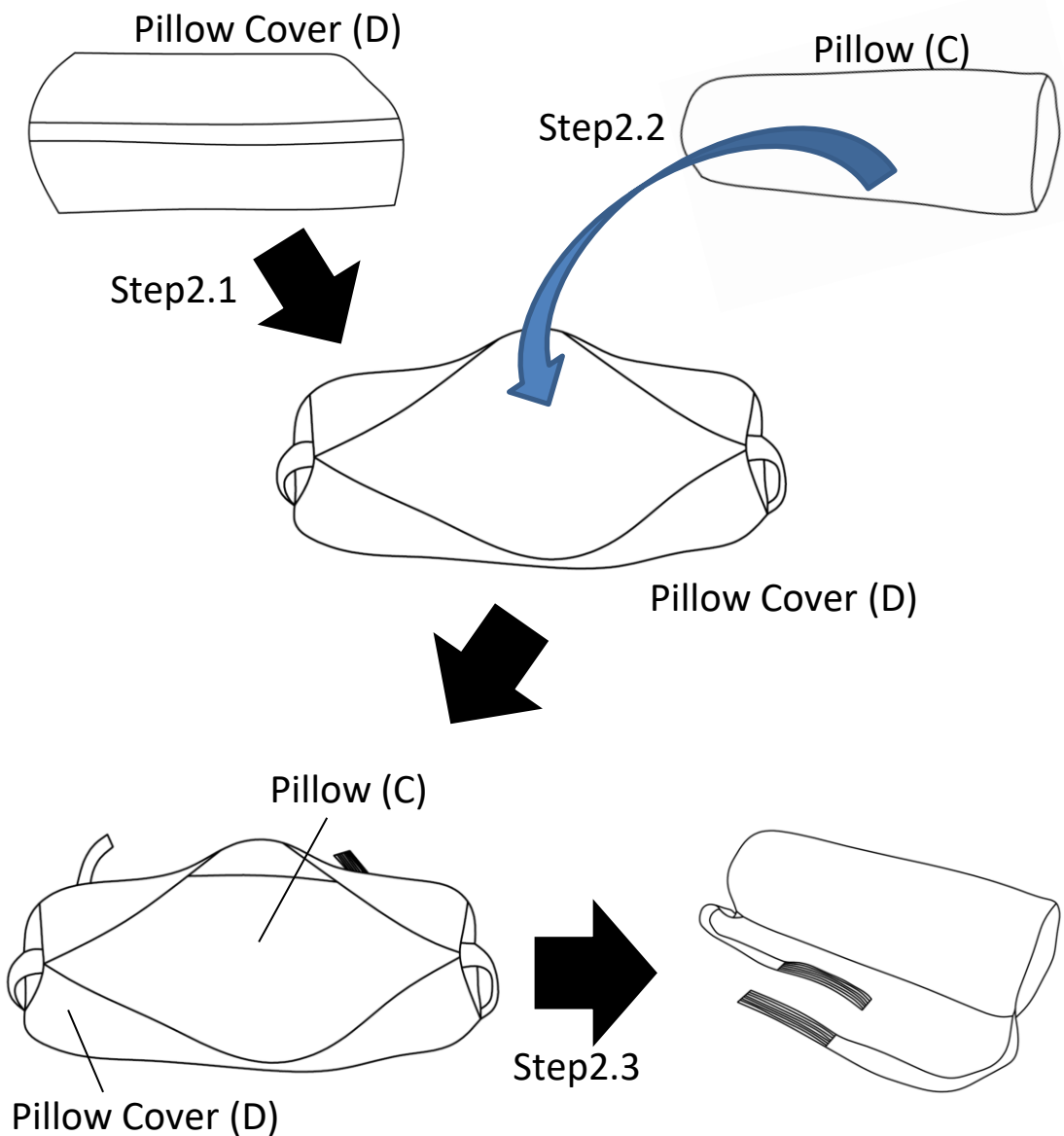

Step2.1 Unzip the Pillow Cover (D) as shown

Step2.2 Put the Pillow (C) into the Pillow Cover (D) in the same length direction

Step2.3 Close up the zipper of the Pillow Cover (D), then tap the Pillow (C+D) a little to make it round as shown.

Step 3

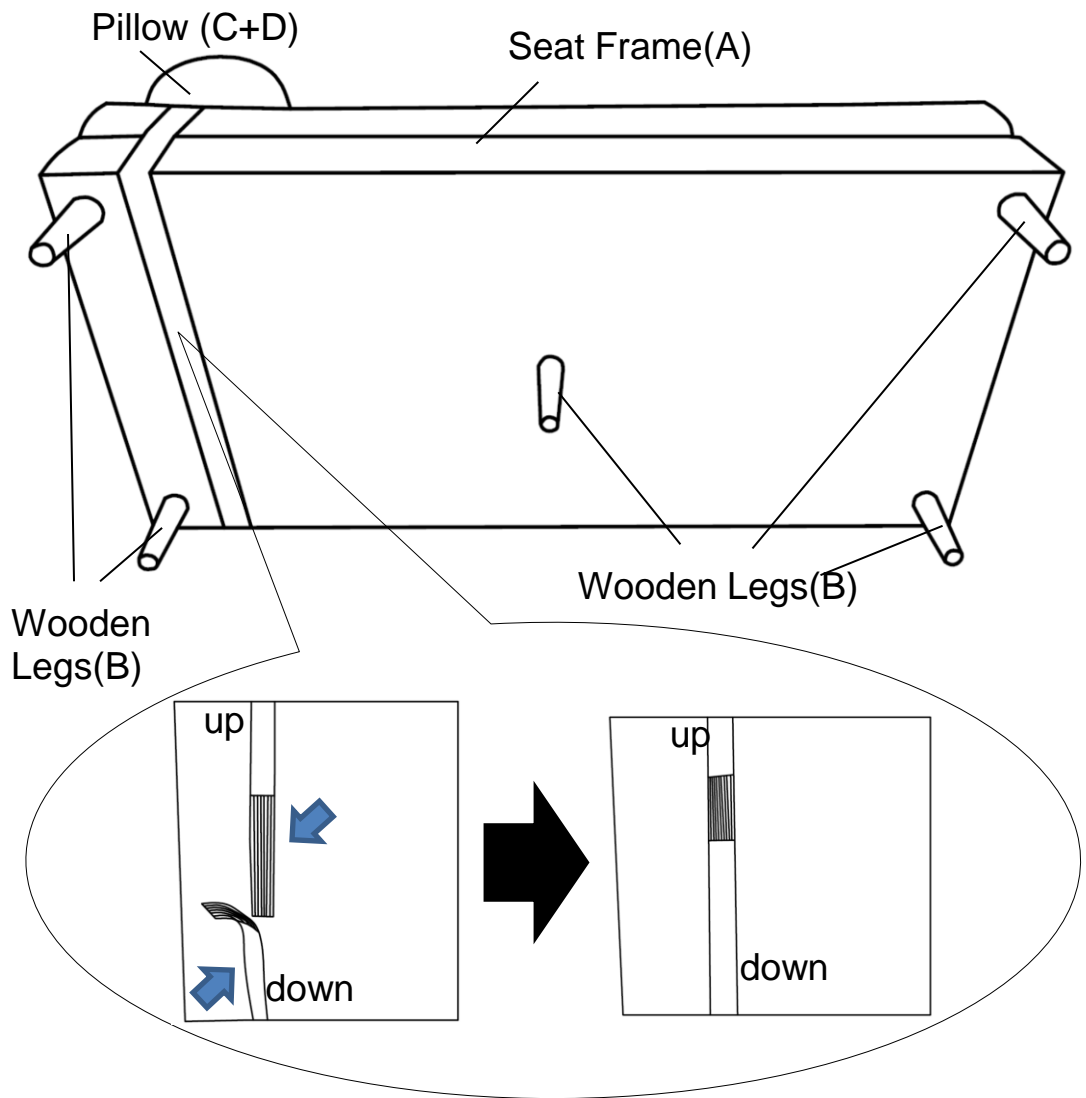

Install the Pillow (C+D) on the Seat Frame(A) as shown.

Step 4

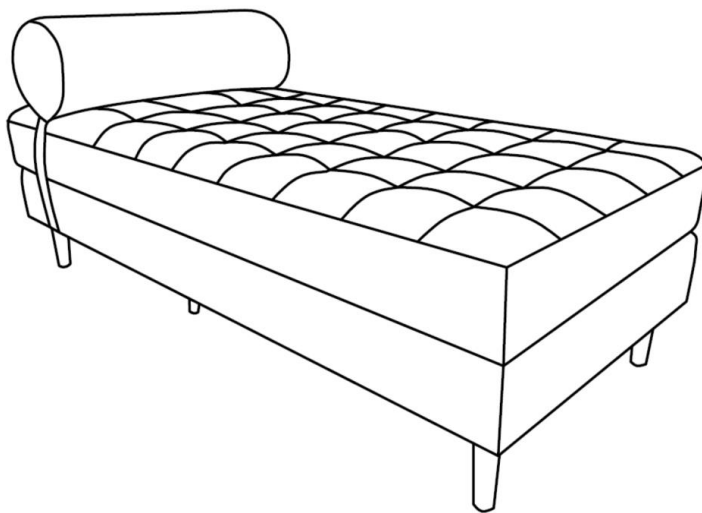

Place the Chaise in an upright position.

Your Chaise is ready for use.

This Chaise can only be used on a flat, level surface.

Care & Maintenance



- Furniture may scratch floors. We recommend using furniture pads to protect your floors.



- Do not put hot items directly on furniture surface.



- Do not clean furniture with harsh cleansers or polish.



- Do not place furniture under direct sunlight.



- Do not place furniture near heating or cooling vents.



- Do not write on furniture without a padded barrier to protect the surface.



- Do not place furniture outside . For indoor use only.



- Not for commercial use. For residential use only.



- Stains may be removed with mild soap solution and damp cloth.



- Children should not climb or jump on the furniture.



- Dust and pick-up spills using a clean, non-colored, lint-free cloth.