

# ASSEMBLY INSTRUCTIONS



Fine Furniture for every stage of life

LOVESEAT

REVISION 0 : 08/01/2018  
REVISION 1 : 05/18/2019  
REVISION 2 : 05/08/2020  
REVISION 3:10/13/2022  
REVISION 4:10/26/2023

# ASSEMBLY INSTRUCTIONS

## ASSEMBLY TIPS:

- 1.Remove hardware from box and sort by size.
- 2.Please check to see that all hardware and parts are present prior to start of assembly.
- 3.Please follow attached instructions in the same sequence as numbered to assure fast & easy assembly.



### WARNING !





- 1.Don't attempt to repair or modify parts that are broken or defective. Please contact the store immediately.
- 2.This product is for home uses only and not intended for commercial establishments.





**ASSEMBLY TIME 20 MINUTES**

## PARTS IDENTIFICATION

## HARDWARE IDENTIFICATION

<b>A</b>		<b>LOVESEAT</b>	<b>1PC</b>
<b>B</b>		<b>BACK CUSHION</b>	<b>2 PCS</b>
<b>C</b>		<b>SEAT CUSHION</b>	<b>2 PCS</b>
<b>D</b>		<b>PATTERNED PILLOW</b>	<b>2 PCS</b>
<b>E</b>		<b>LEGS</b>	<b>4 PCS</b>

1	BOLT (M8 x 20MM-BLK)		8PCS
2	FLAT WSAHER (M8-BLK)		8PCS
3	ALLEN WARENCH (6#-BLK)		1PC

# ASSEMBLY INSTRUCTIONS

## STEP1

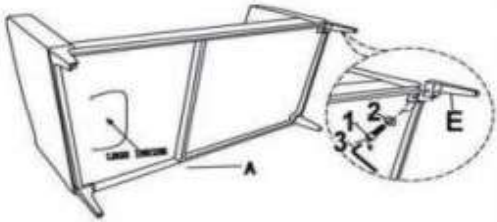

## STEP2

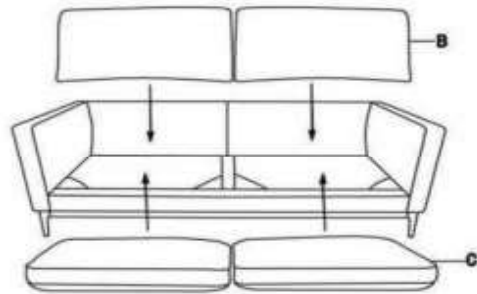

## STEP3

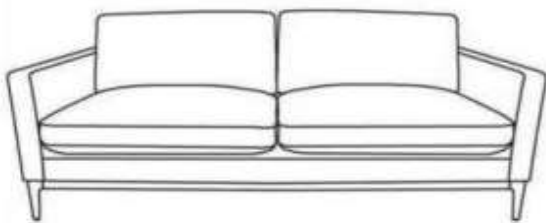

## STEP4

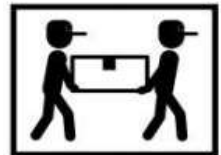
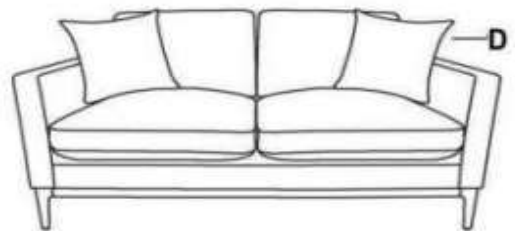

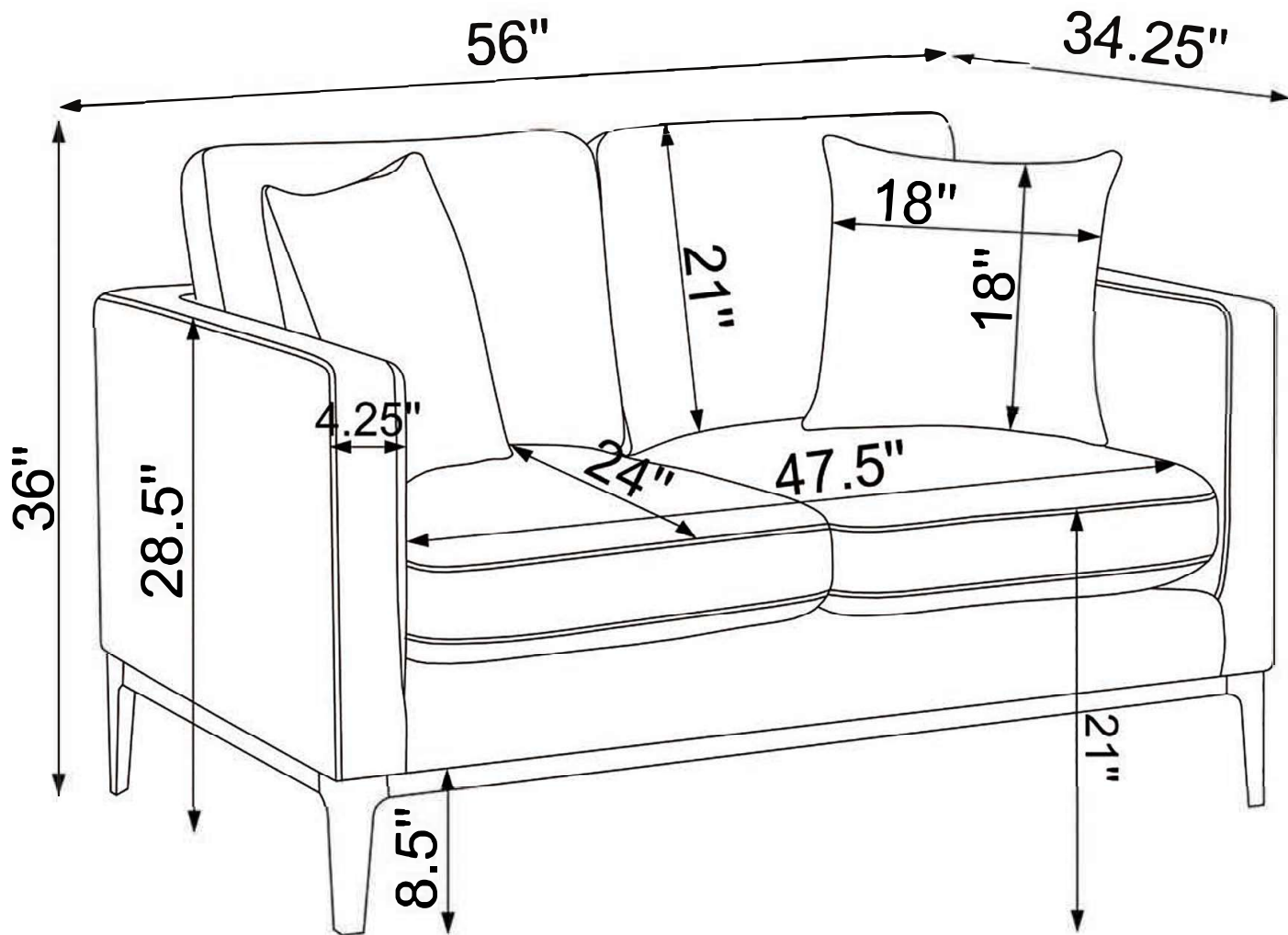

**Note : Dimension tolerance  $\pm 5\%$**