

# Assembly Instruction

## ASSEMBLY TIPS:

- 1.Remove hardware from box and sort by size.
- 2.Please check to see that all hardware and parts are present prior to start of assembly.
- 3.Please follow attached instruction in the same sequence as numbered to assure fast & easy assembly.



### Warning!

- 1.Don't attempt to repair or modify parts that are broken or defective. Please contact the store immediately.
- 2.This product is for home use only and not intended for commercial establishment.

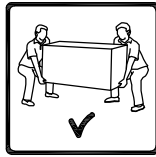





ASSEMBLY TIME 10 MINUTES

## PARTS IDENTIFICATION

- A  NIGHT STAND 1PC
- B  LEG 4PCS

## HARDWARE IDENTIFICATION

- |   |   |              |      |
|---|---|--------------|------|
| 1 |    | BOLT         | 8PCS |
| 2 |    | LOCK WASHER  | 8PCS |
| 3 |    | FLAT WASHER  | 8PCS |
| 4 |  | ALLEN WRENCH | 1PC  |

## STEP 1

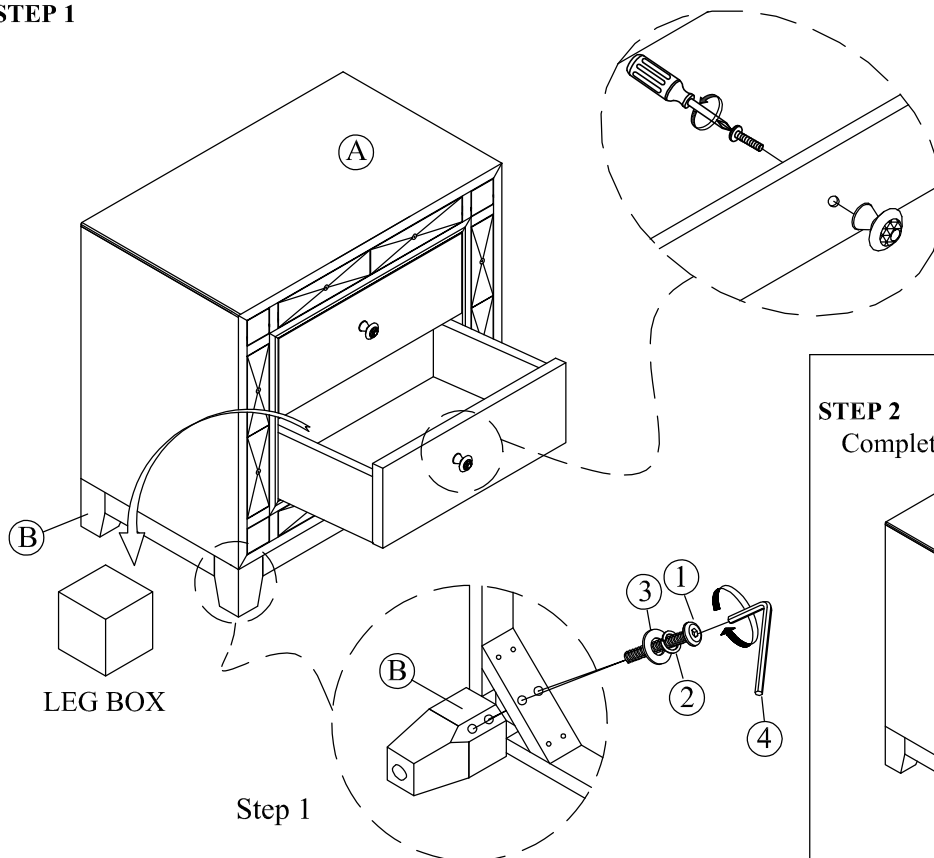

## STEP 2 Complete

