







Ⓐ		— 2
Ⓑ		— 2
Ⓒ		— 4
Ⓓ		— 1
Ⓔ		— 2
Ⓕ		— 1
Ⓖ		— 2
Tool (Not included)		
Ⓕ		

Mobile File Cabinet Assembly Instruction

All accessories are put in the middle drawer

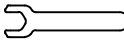

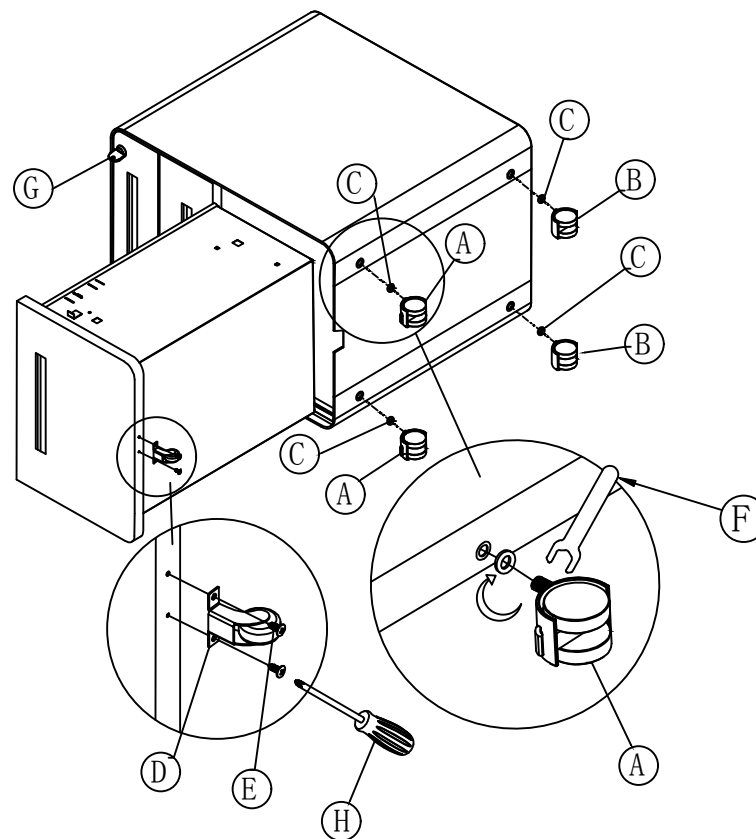
DCO3 cold-rolled steel plate, cabinet panel thickness 0.7mm, bucket circumference 0.6mm, main beam support 1.2mm

The cabinet under the table is used to store personal office supplies, etc. The large drawer can satisfy any hanging work.