

INSTRUCTION MANUAL

Retractable Textilene Arched Pergola

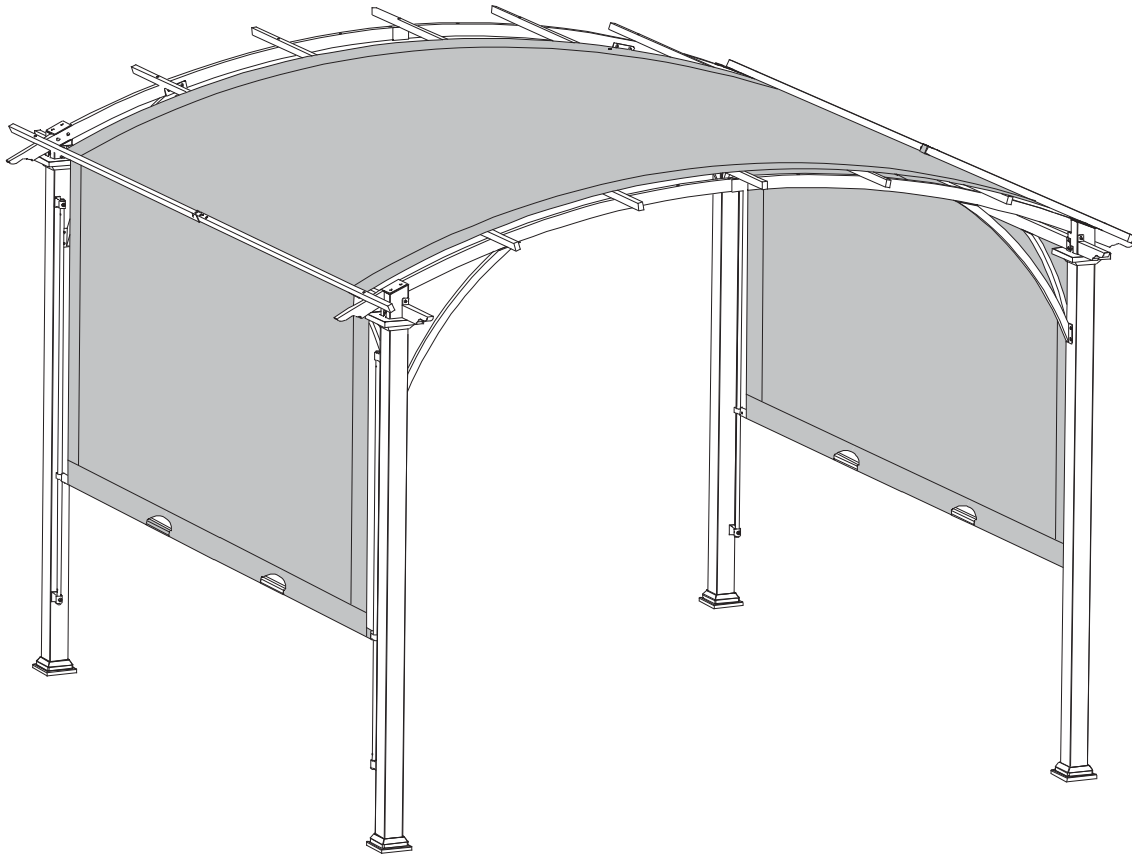

To inquire about replacement parts,
please email to teamaftersale@outlook.com.



LIMITED WARRANTY

For warranty, please email teamaftersale@outlook.com for customer service before returning the product to our shop. The purchaser must obtain prior authorization from the Customer Service.

Global Shade Corporation offers a limited warranty that this product is free from defects in materials and workmanship for a period of one (1) year from the original date of purchase. At its discretion, **Global Shade Corporation** may provide replacement parts for defective parts to original purchaser after its own review and examination. Original receipt or proof of purchase as well as proof of defect is required. **Global Shade Corporation** will not be responsible for shipping costs incurred outside the continental USA. Warranty is valid for the original purchaser for 1 year from the date of purchase and is not transferable. Regular maintenance of wood, aluminum, and steel components is required to assure the integrity of your product and is a requirement of the warranty. This warranty does not cover any inspection costs.

This Limited Warranty does not cover:

- Labor for replacement of any defective item(s);
- Incidental or consequential damages;
- Cosmetic defects which do not affect performance or integrity;
- Vandalism; improper use or improper installation; acts of nature, including but not limited to wind, storms, hail, floods, excessive water exposure;
- Structural or component failure due to snow loading.
- Minor twisting, warping, checking, cracking, or any other natural occurring properties of wood that do not affect performance or integrity.

Global Shade Corporation's products have been designed for safety and quality. Any modifications made to the original product could damage the structural integrity of the product leading to failure and possible injury. **Global Shade Corporation** cannot assume any responsibility for modified products. Furthermore, modification voids any and all warranties.

All replacement products or parts will assume the remaining warranty of the original product. This warranty gives you specific legal rights. You may also have other rights, which vary from state to state.

This product is warranted for RESIDENTIAL USE ONLY. Global Shade Corporation disclaims all other representations and warranties of any kind, express or implied.

Global Shade Corporation does not warrant against and under no circumstances shall Global Shade Corporation be liable or responsible for any personal loss, injury, or direct or indirect incidental or consequential damages resulting from the use of this product.

This Warranty gives you specific legal rights. You may have other rights as well which vary from state to state or province to province. This warranty excludes all consequential damages, do not allow the limitation or exclusion of consequential damages, and therefore this limitation may not apply to you, however, some states/provinces do not allow the limitation or exclusion of consequential damages, and therefore this limitation may not apply to you.

WARNING:



To reduce the risk of serious injury, read the following safety instructions thoroughly before assembling and using the pergola.

- Check with your local governing authority/local municipal codes regarding installation and permitting of such structures before assembly.
- Use of personal protective equipment including gloves, safety glasses, and closed toe footwear is recommended during assembly.
- Requires two or more people to assemble and install safely and correctly.
- The product is required to be installed on level solid surface and is not intended for unsecured use. The pergola is to be anchored to the surface with appropriate bolts or anchors. These anchors need to be purchased separately for the specific installation surface. Do not assemble the pergola on soil, earth, or bare ground.
- Ensure enough clearance around the product. Before assembling the product, find level ground no less than 6' (1.8 m) away from any structures or obstructions, such as fences, buildings, or overhead obstacles.
- Do not assemble or install the pergola underneath electrical lines or above underground utilities.
- Check for underground utilities before digging or driving stakes into the ground.
- This pergola is not to be regarded as part of a building/house structure.
- All assembly and maintenance of the product must be carried out by adults only.
- Use all power tools and hand tools in accordance with their respective safety manuals.
- Keep children and pets away while setting up the pergola.
- Do not hang heavy weights from the roof frame.
- Do not climb onto the roof of the pergola for any reason.
- Check all nuts and bolts monthly to ensure bolts/nuts are tightened.
- Check the metal hardware monthly to ensure there are no exposed sharp edges or rust. Sand sharp edges or rust with sandpaper and apply touch up paint. Always use lead free paint that conforms to 16 CRF Part 1303.

Needed for assembly: *(The following tools are not included)*

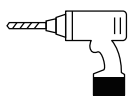

Pistol Drill

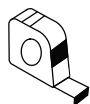

Tape Measure

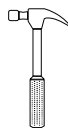

Hammer



Screwdriver



Level

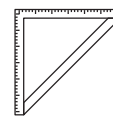

Framing Square











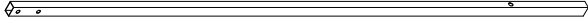

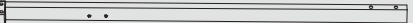

Ladder



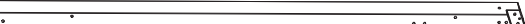











Two or more people



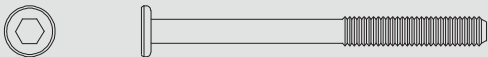
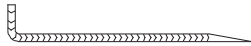
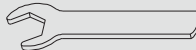

Part List







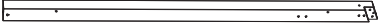

Label	Description	Sketch	QTY
A1	Roof Tube A1		7
A2	Roof Tube A2		7
B1	Roof Tube Curved B1		2
B2	Roof Tube Curved B2		2
B3	Connector B3		2
C1	Lintel C1		2
C2	Lintel C2		2
D	Decoration for Post		4
D4	Top Cover for Post		4
E	Post E		2
F	Post F		2
G	Base		4
H	Base Cover		4
I1	Corner Brace I1		2
I2	Corner Brace I2		2















Part List

Label	Description	Sketch	QTY
J1	Corner Brace J1		2
J2	Corner Brace J2		2
L	Connector L		8
M	Weight Bar M		2
N	Weight Bar N		2
O	Guide Tube		4
P	Shade Fabric		1
AA	Bolt M6 x 15		88
BB	Bolt M6		128
CC	Bolt M6 x 15		18
DD	Bolt M6 x 55		22
EE	Bolt M6 x 70		8
FF	Stake Ø6 x 230		8
Z1	Wrench M6		2
Z2	Allen Key M6		1

Box Contents

BOX 1		
Label	Sketch	QTY
A1		7
A2		7
E		2
F		2
G		4

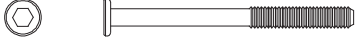
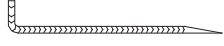
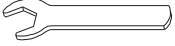
BOX 2		
Label	Sketch	QTY
B1		2
B2		2
B3		2
C1		2
C2		2
D		4
D4		4
H		4

BOX 2		
Label	Sketch	QTY
I1		2
I2		2
J1		2
J2		2
L		8
M		2
N		2
O		4
P		1
AA		88
BB		128
CC		18
DD		22
EE		8
FF		8
Z1		2
Z2		1

Step 1

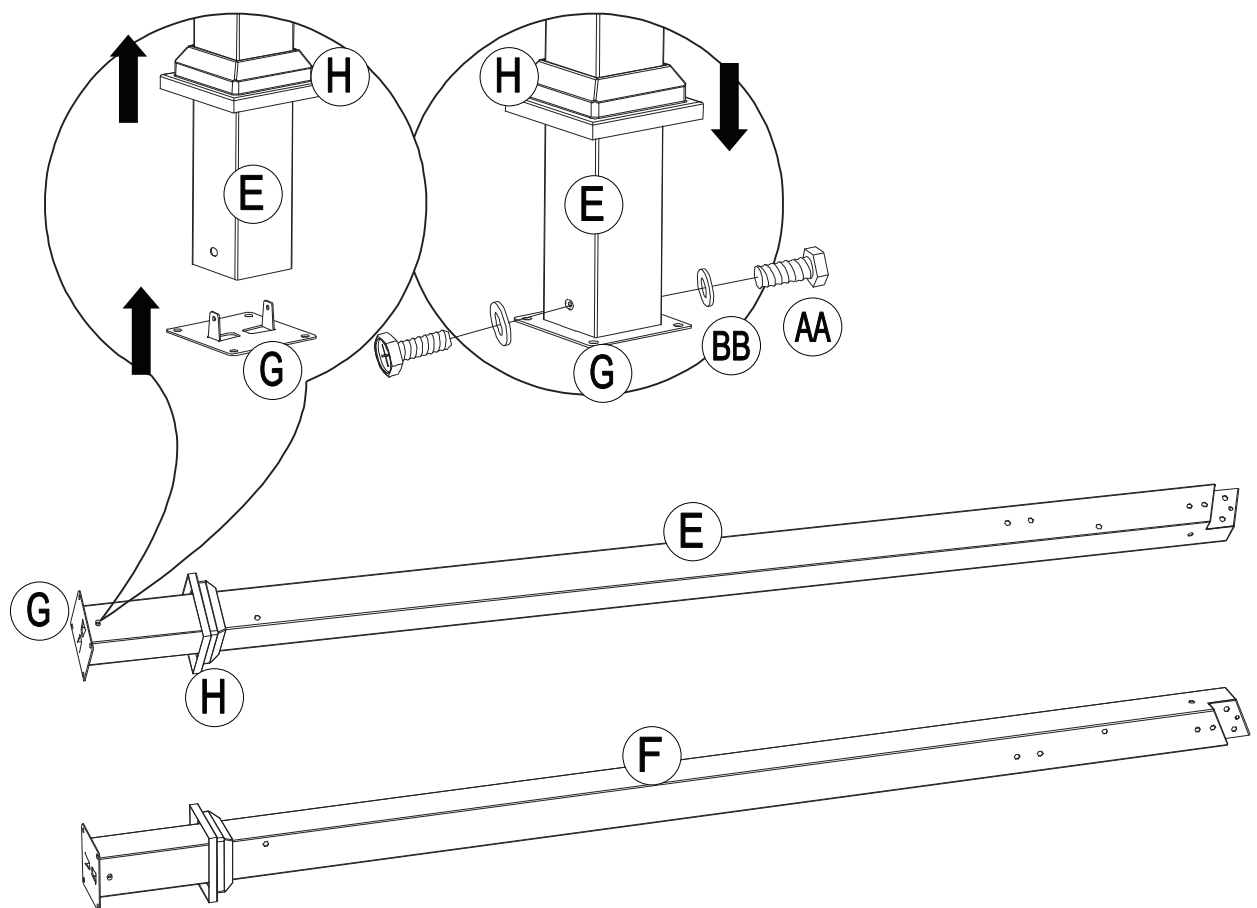
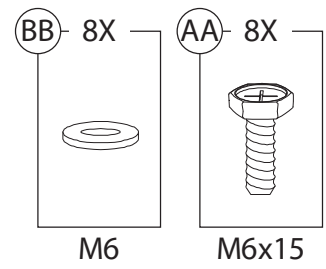
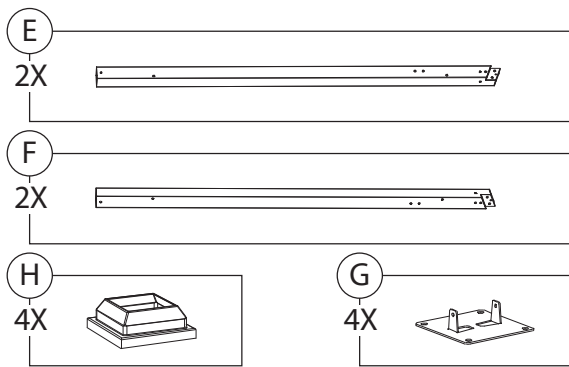

Step 2

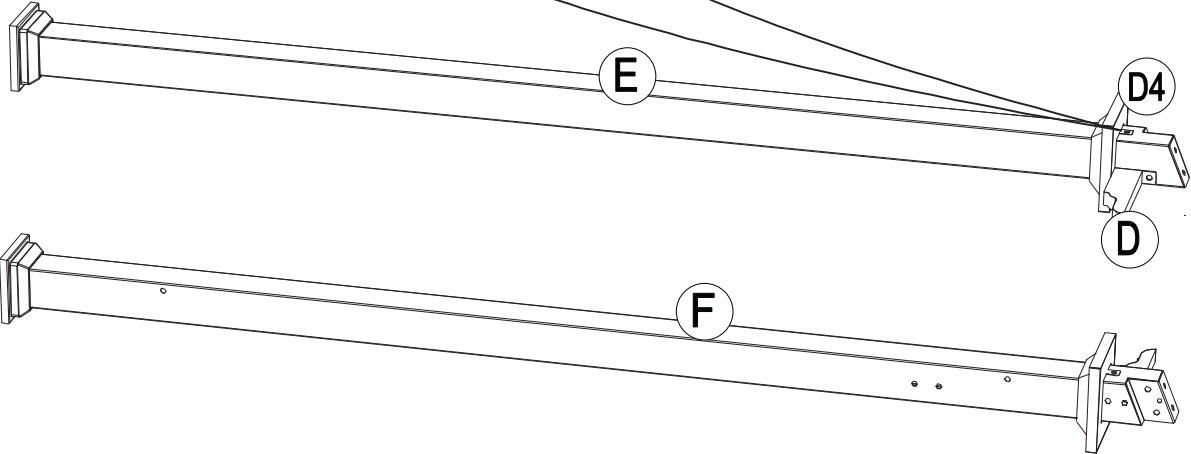
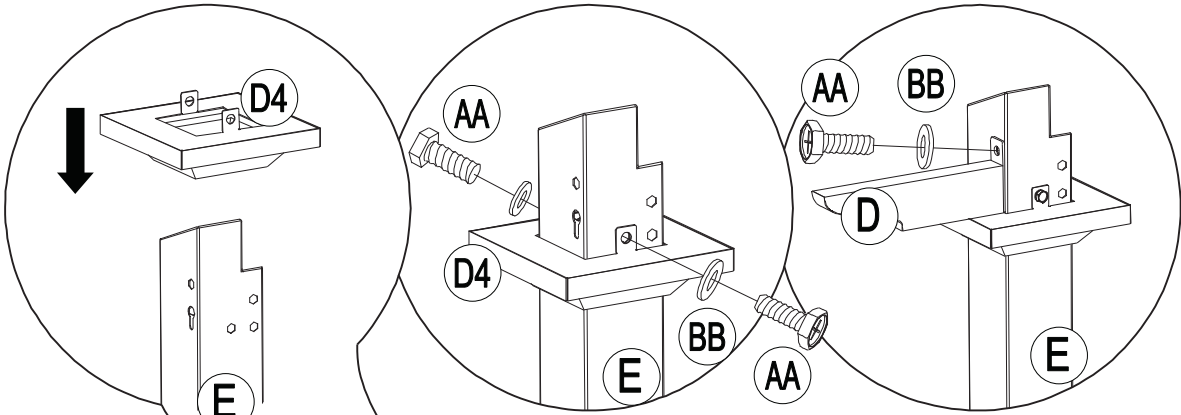
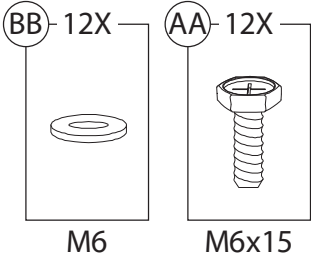
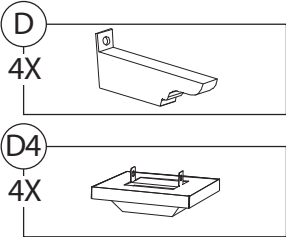

Step 3

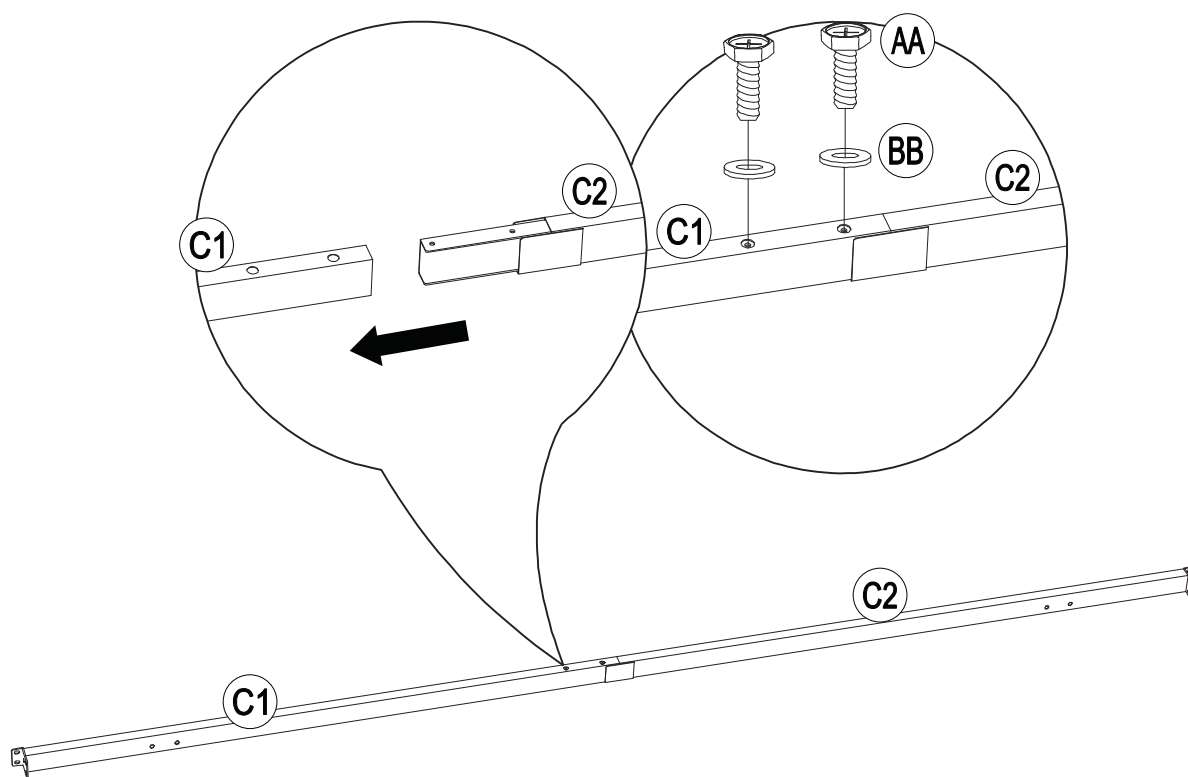
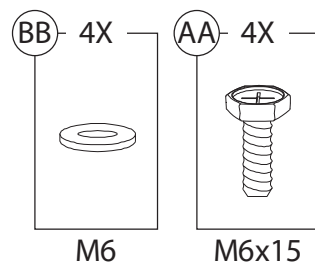
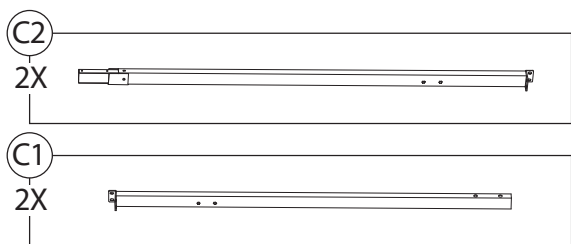

Step 4

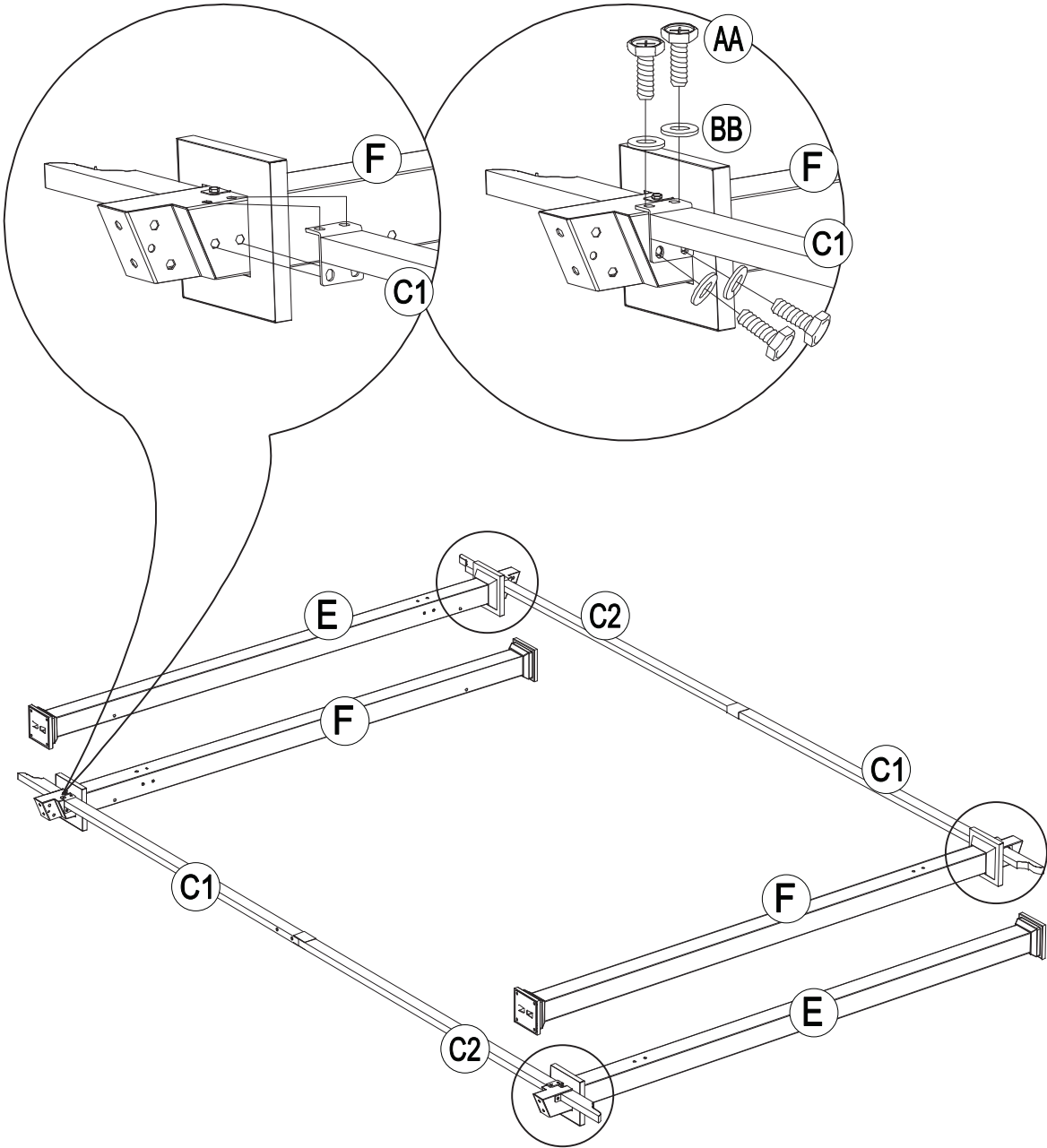
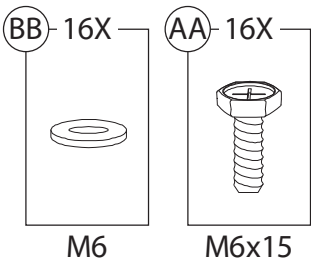

Step 5

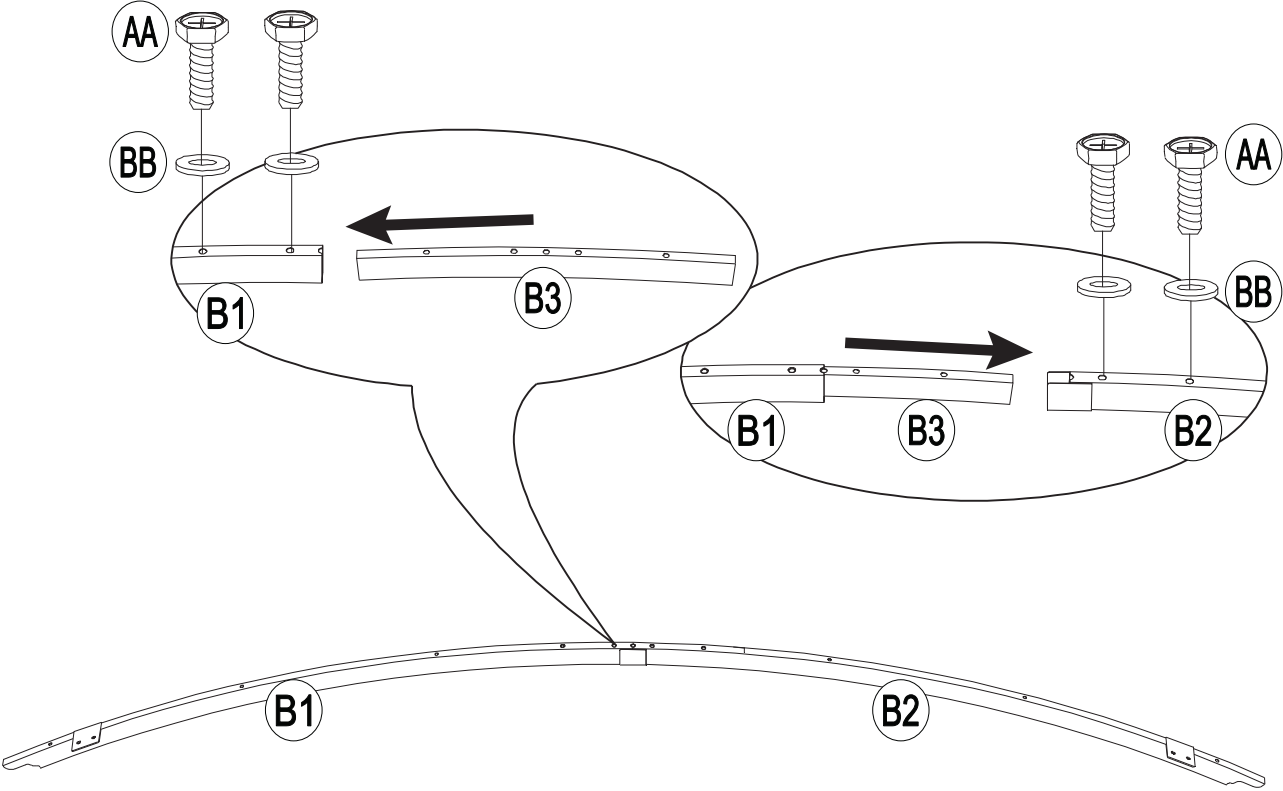
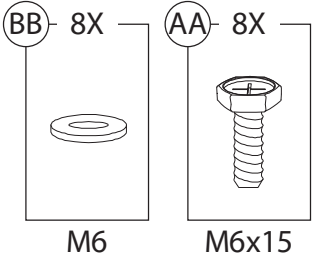
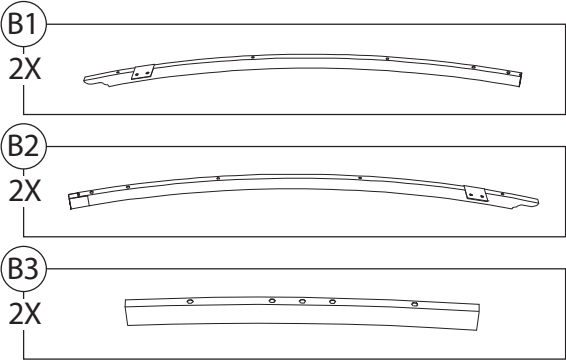

Step 6

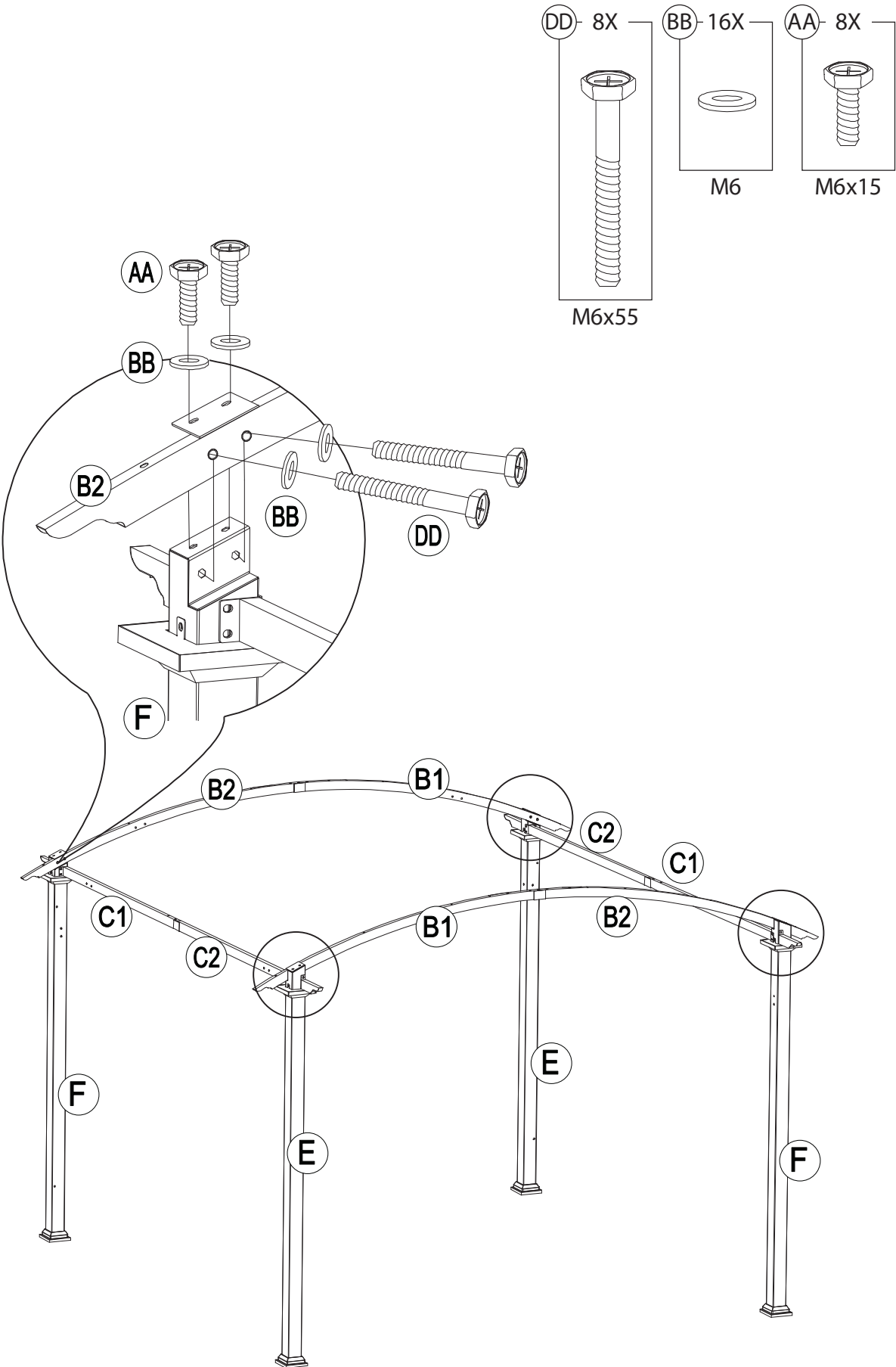

Step 7

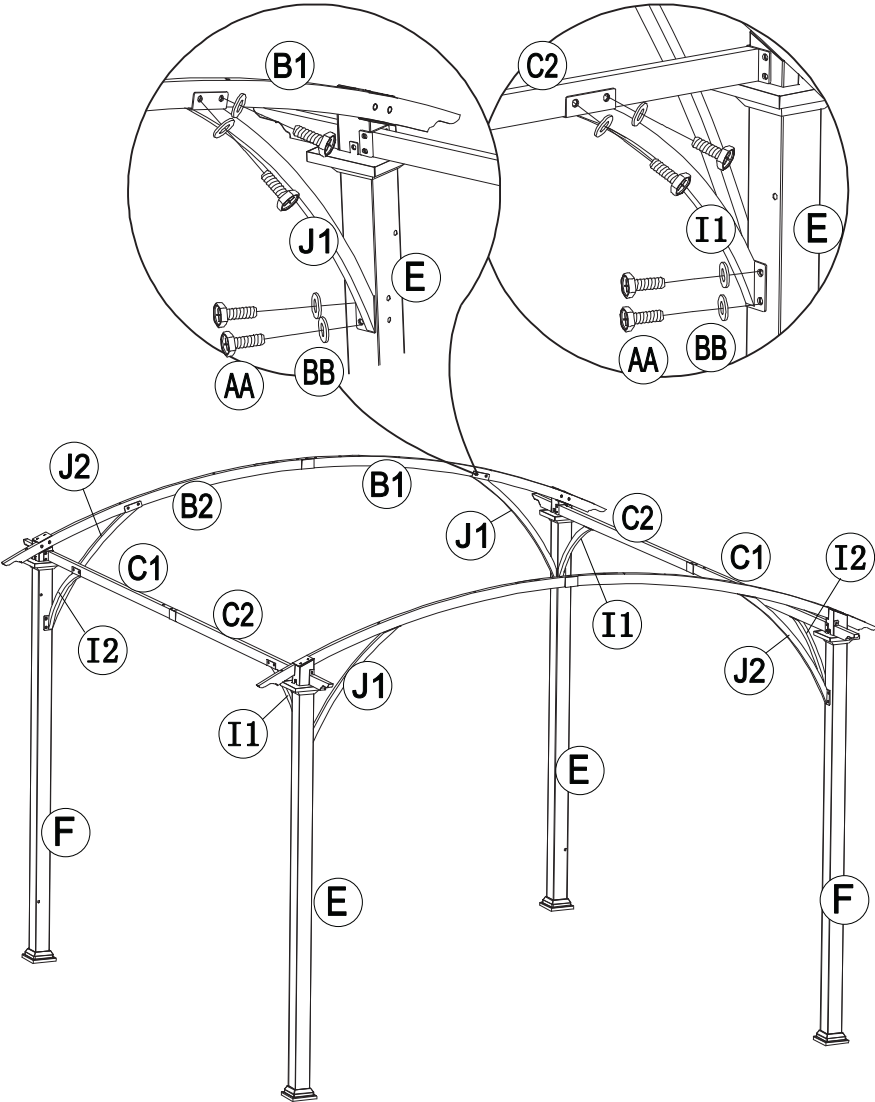
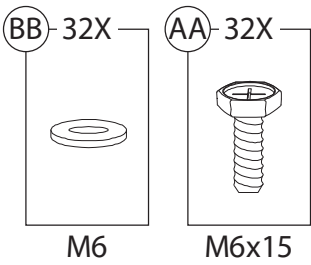
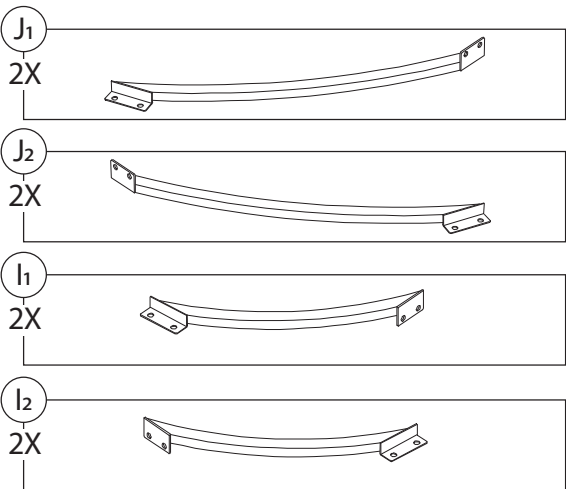

Step 8

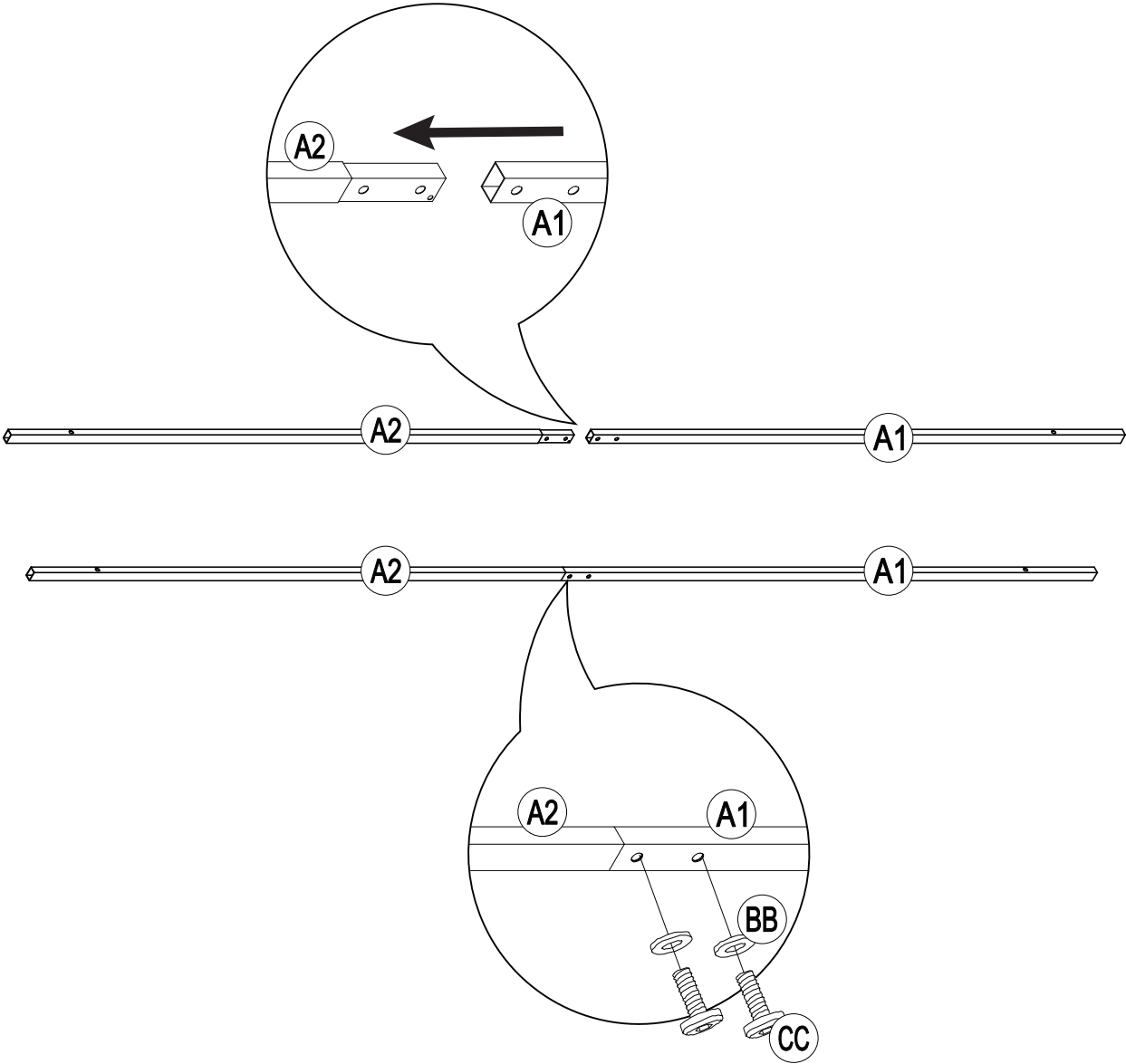
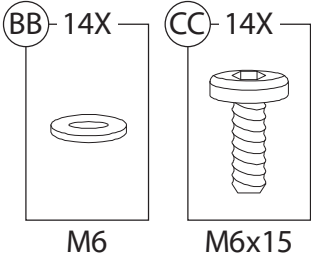
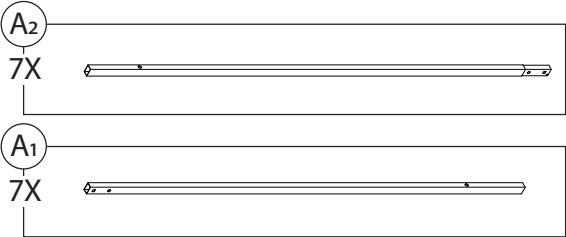

Step 9

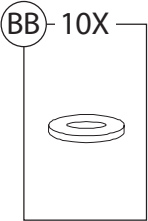

M6

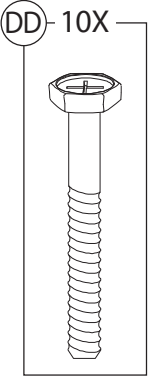

M6x55

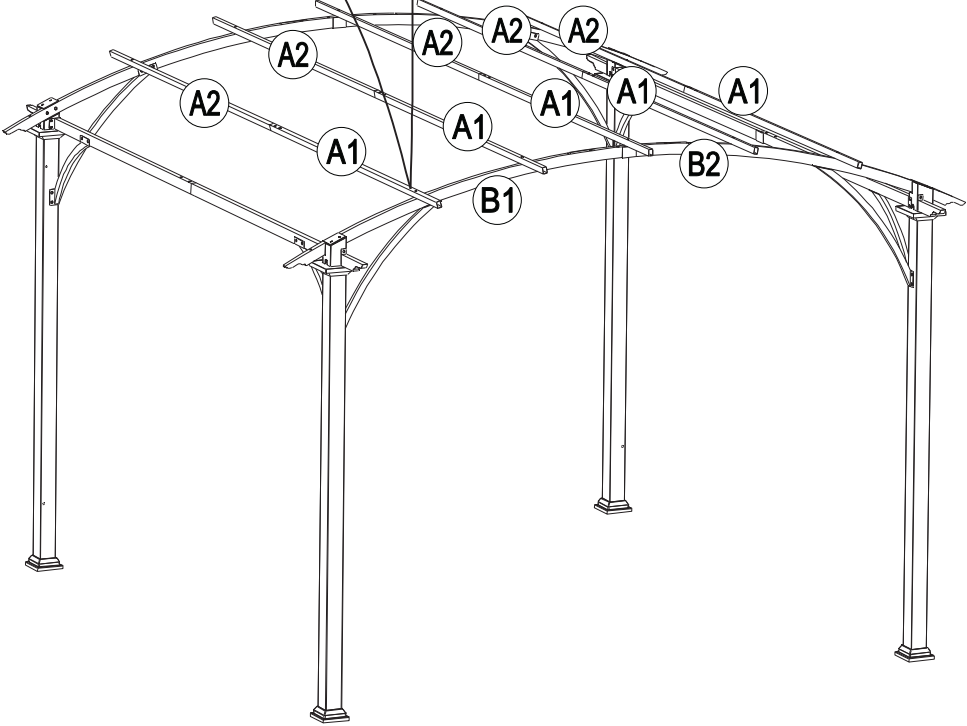
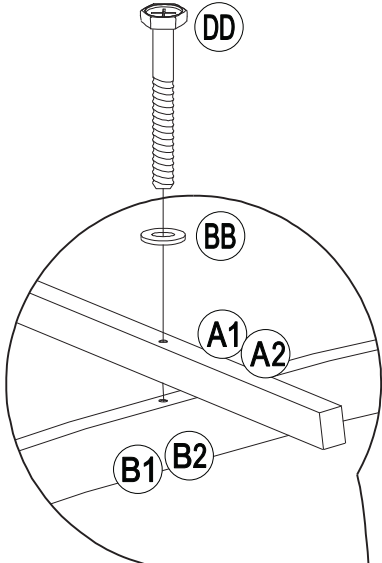

Step 10

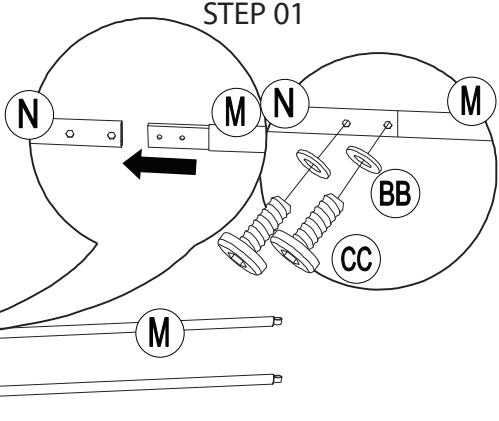
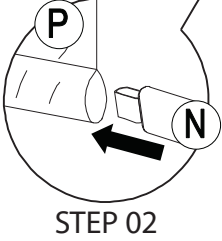
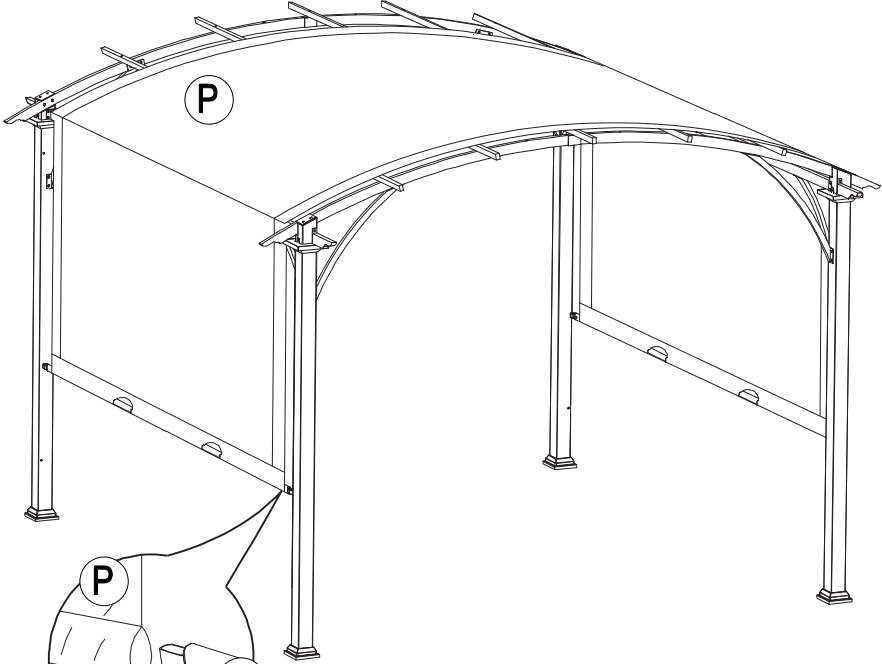
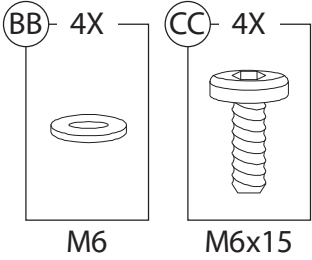
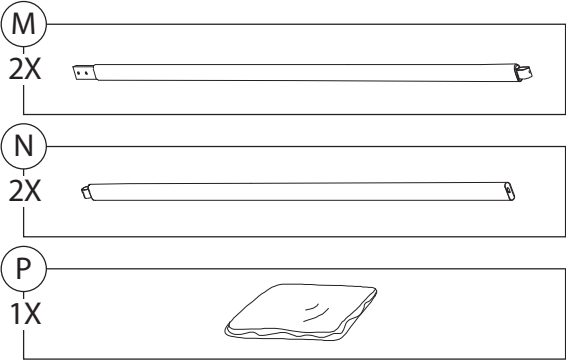

Step 11

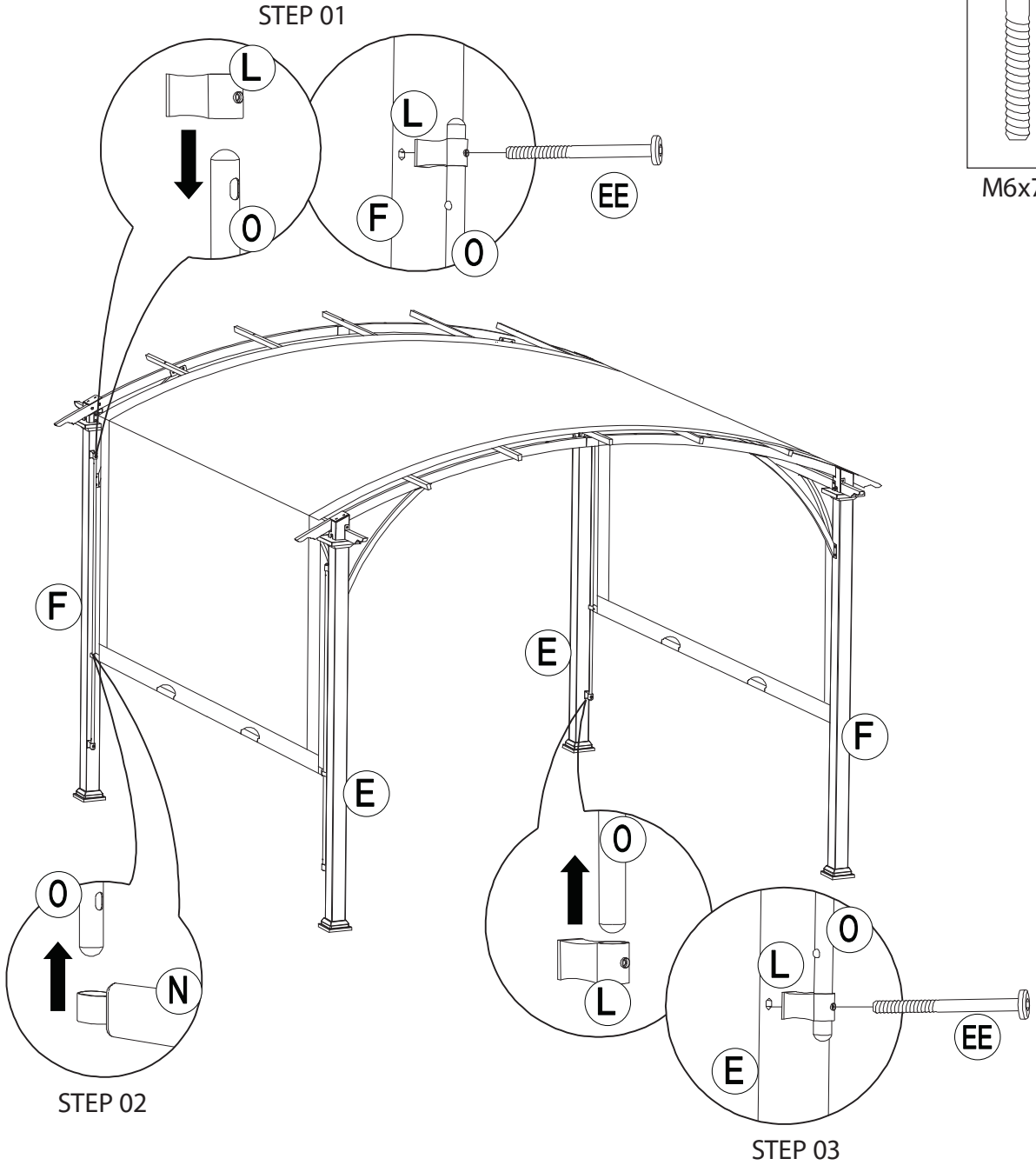
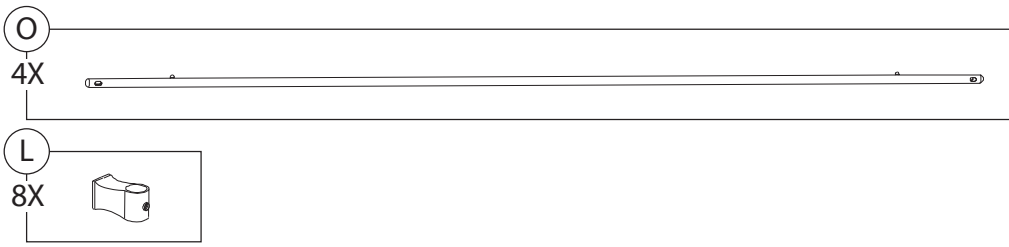

Step 12

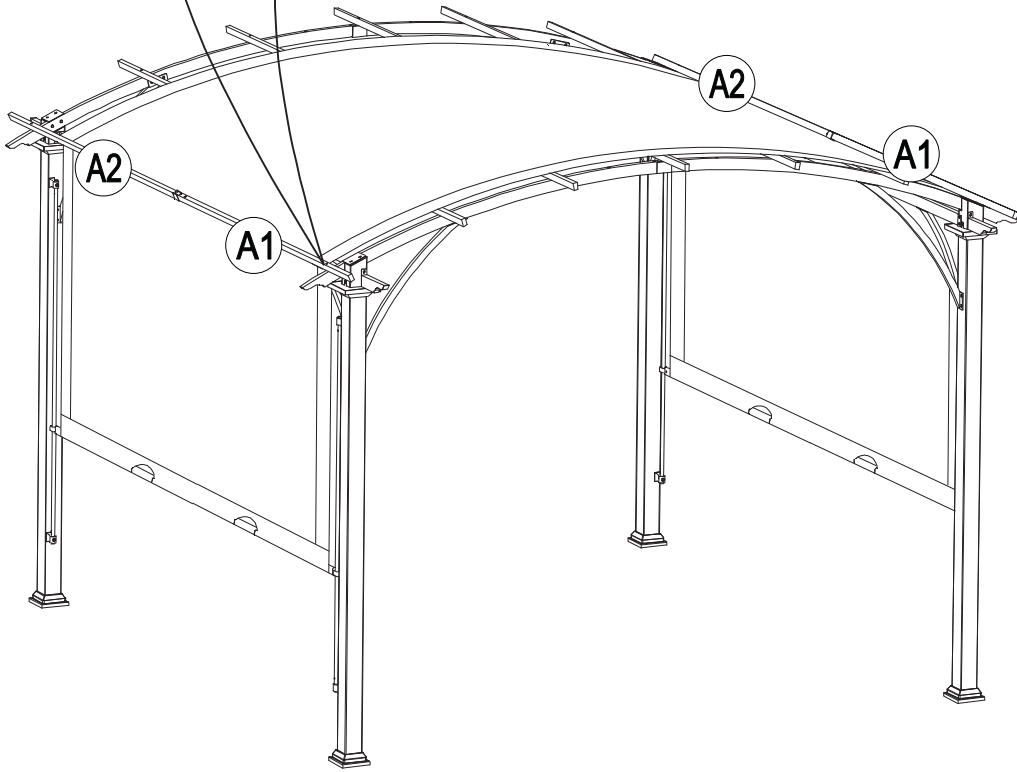
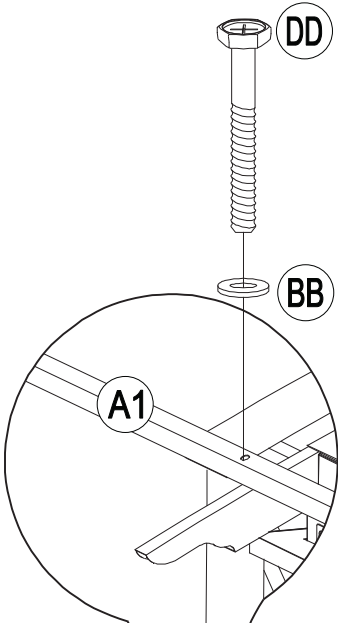
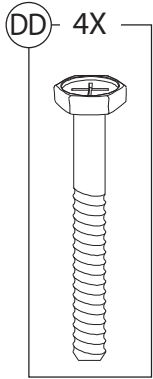
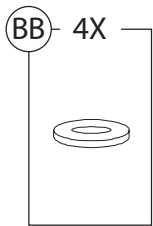
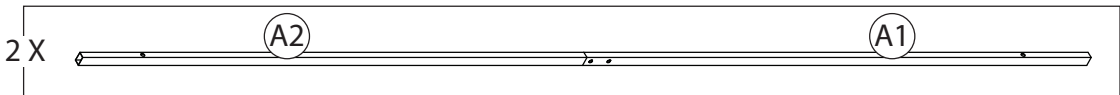

Step 13

