

INSTALLATION INSTRUCTIONS

DeerValley®

Bathroom Shower Enclosure

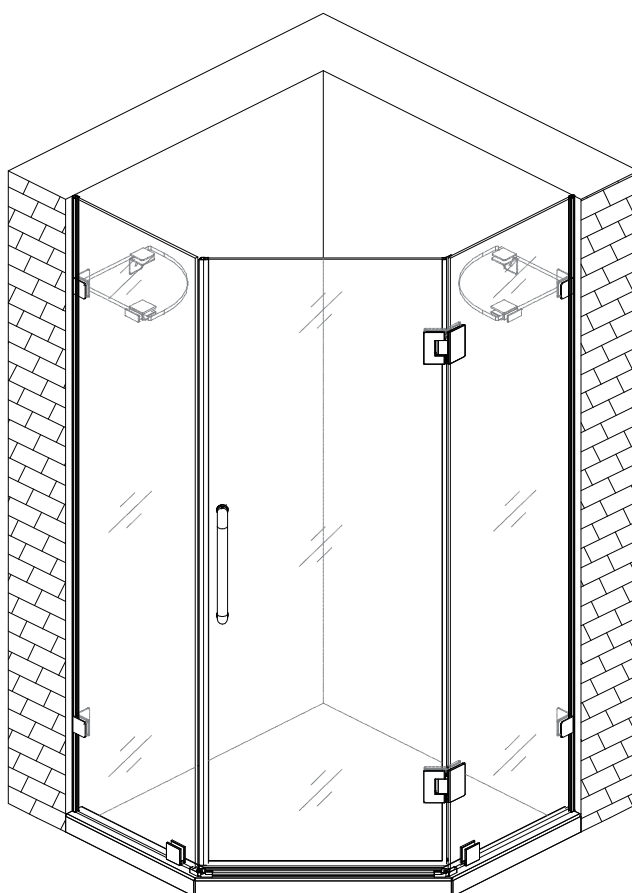

Product Breakdown Diagram

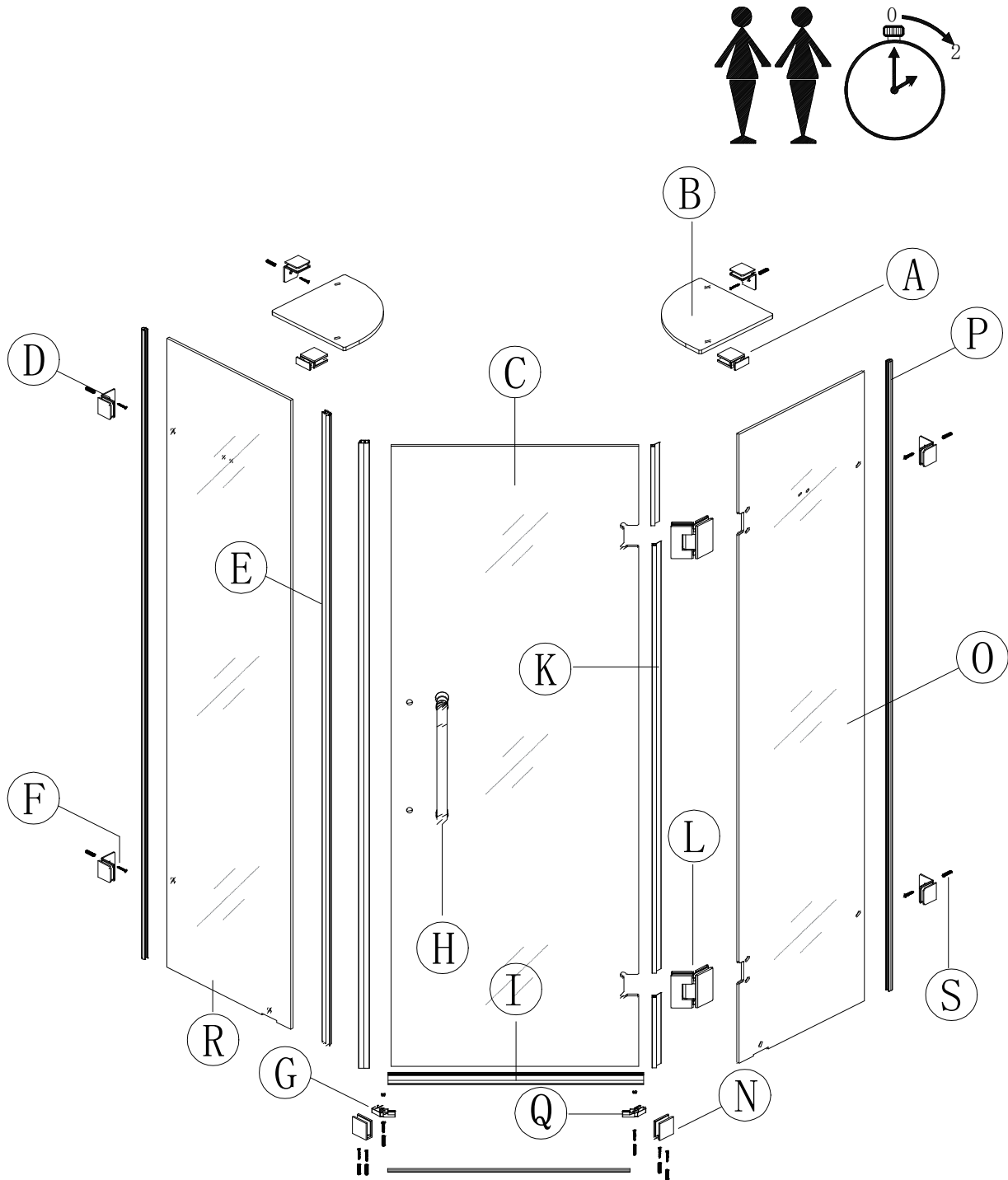

**If you have any questions or concerns
please contact us:**

(+1) 312-626-9466
service@deervalleybath.com

General Information

Please inspect the product immediately upon receipt for any transit damage, missing parts, or manufacturing faults. Damage reported at a later time cannot be accepted. Please handle the product with care, avoiding knocks and shocks to all sides and edges of the glass.

Please read these instructions carefully before starting the installation. Special care should be taken when drilling walls to avoid hidden pipes or electrical cables.

Note: This product is heavy and requires two people for installation.

Cleaning and Maintenance

1. For daily cleaning of the shower enclosure, you can use a mild liquid detergent and a soft cloth.
2. If there are stains, gently wipe them with a clean, soft towel or a small amount of neutral soap solution or toothpaste.
3. To enhance the shine of the glass surface, you can polish it using a glass polish.

Attention

1. Avoid using acids, alkalis, or sharp tools when cleaning to protect the gloss of the shower tray, glass, and aluminum fittings.
2. Do not use strong detergents containing acetone or ammonia; avoid disinfectants with formic acid and formaldehyde to prevent damage to the product's surface gloss.
3. During showering, avoid contact or impact with hard objects against the glass surface to prevent accidents.
4. Regularly inspect the condition of the shower enclosure and contact the after-sales service department promptly if any abnormalities are detected.

Tools Details (Not Included)

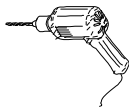
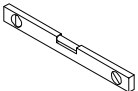
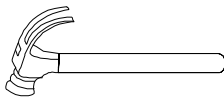
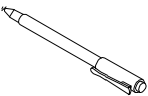
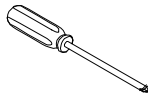
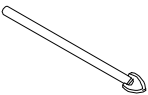
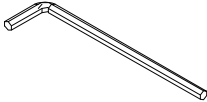
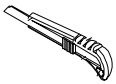
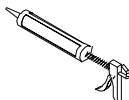
Tool Name	Illustration	Tool Name	Illustration
Tape measure		Drill	
Spirit level		Hammer	
Pen		Screwdriver	
0.24in drill bit		Allen wrench	
Art Knife		Silicone sealant	

Accessory List

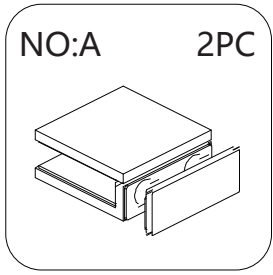

Mounting Clip

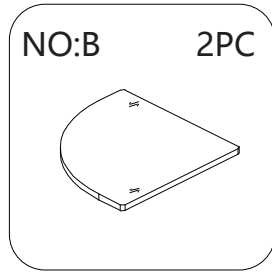

Glass Shelf

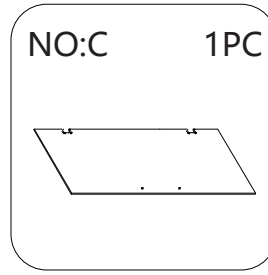

Door Glass

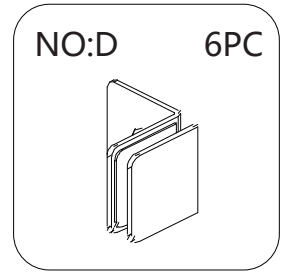

Corner Bracket

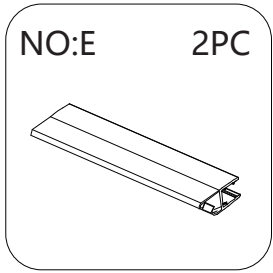

Magnetic Door Strip

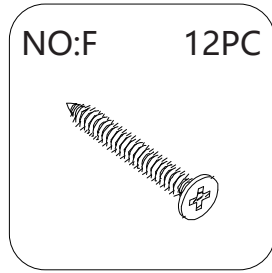

Screw

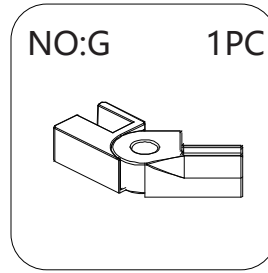

Left Connector

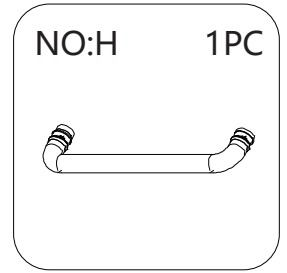

Handle

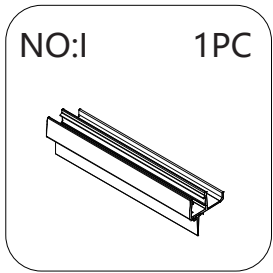

Water Guide

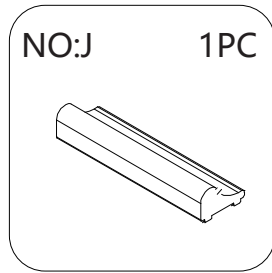

Aluminum Water Stopper

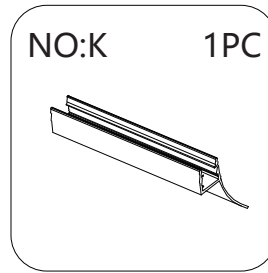

Waterproof Strip

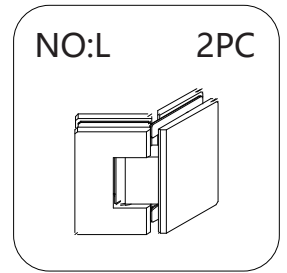

Hinge

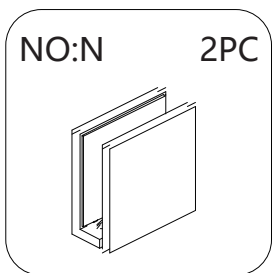

Ground Fixing Clip

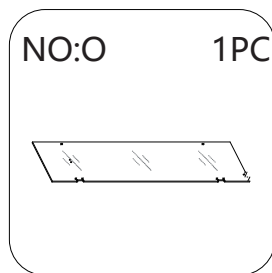

Fixed Glass

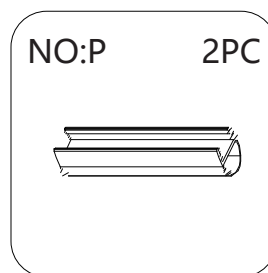

Sealing Strip

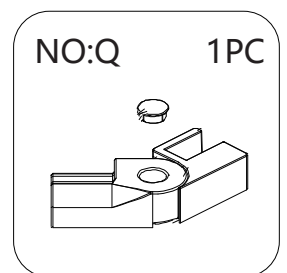

Right Connector

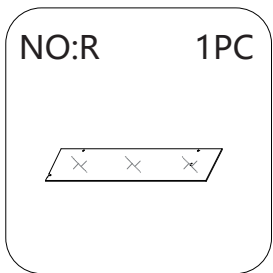

Fixed Glass

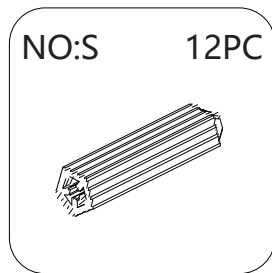

Wall Plug

Drawings may not exactly define contour of the product.

Installation steps

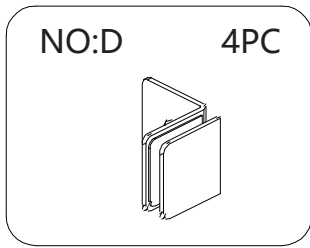

Corner Bracket

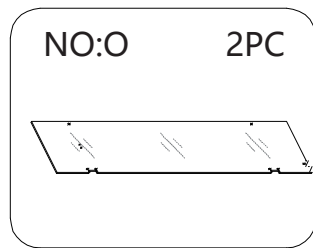

Fixed Glass

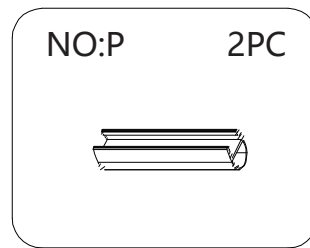

Sealing Strip

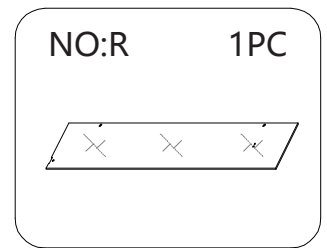

Fixed Glass

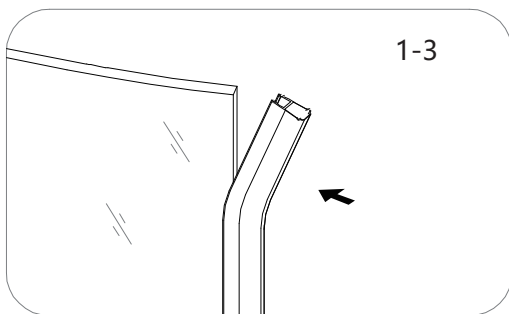
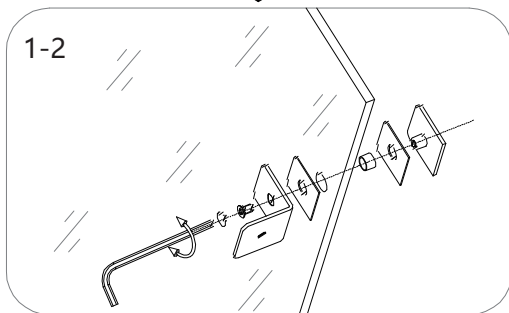
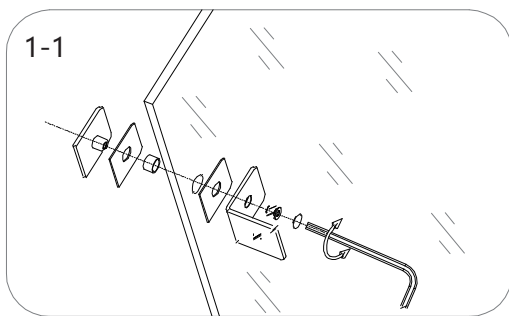

Step 1: Installation components for fixed glass

1-1. Install and fix corner bracket for door magnetic fixed glass.

1-2. Install and fix corner bracket for hinge fixed glass.

1-3. Install sealing strips on the door magnetic fixed glass and hinge fixed glass.

Drawings may not exactly define contour of the product.

Installation steps

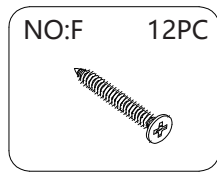

Screw

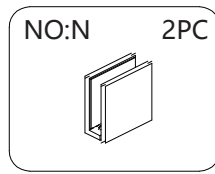

Ground Fixing Clip

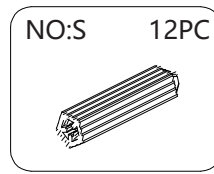

Wall Plug

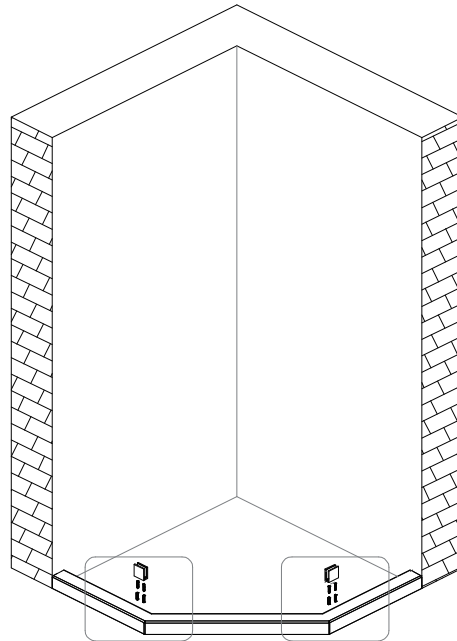
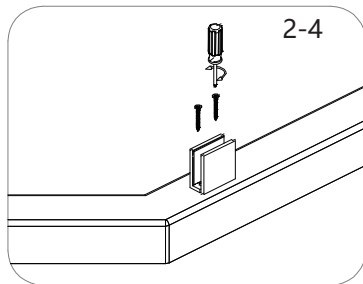
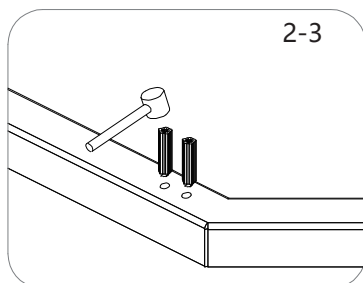
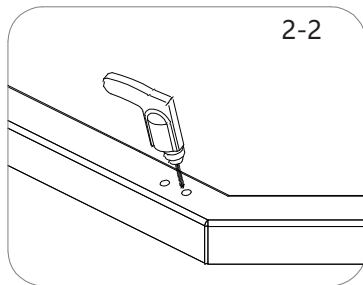
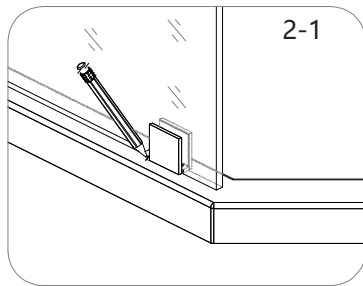

Step 2: Install the ground fixing clip

- 2-1. Attach the glass fixing parts to the glass, position them on the floor/base surface, confirm their specific positions, and use a marker pen to mark and position them.
- 2-2. Use a 6mm drill bit to drill holes at the marked points.
- 2-3. Insert the plug into the hole, ensuring that the end face is flush with the floor/base surface.
- 2-4. Reinforce the ground fixing clips with screws.

Drawings may not exactly define contour of the product.

Installation steps

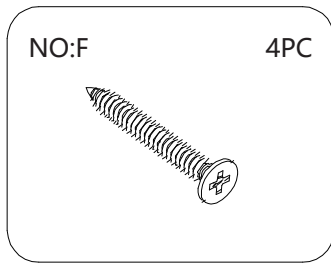

Screw

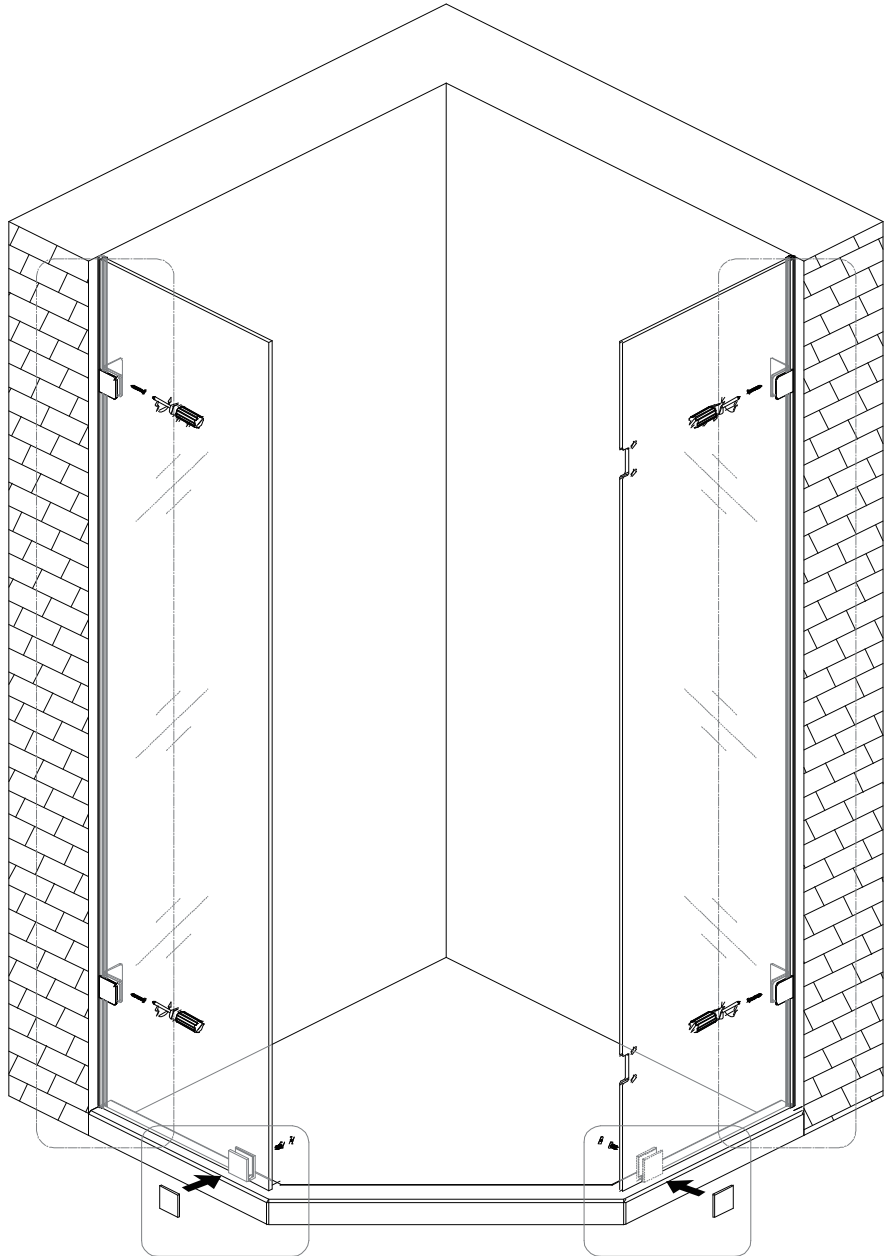
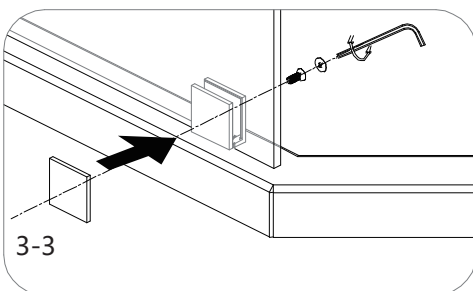
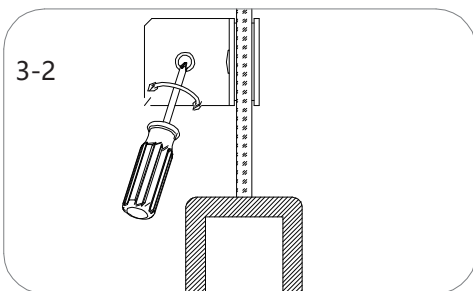
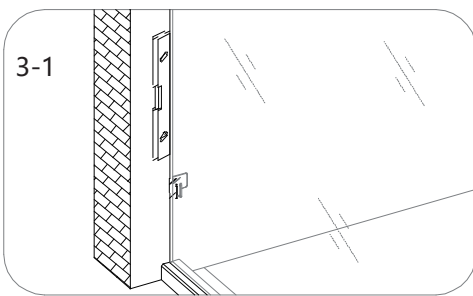

Step 3: Fixing hinge fixed glass and door magnetic fixed glass to the wall

3-1. Position the hinge fixed glass and door magnetic fixed glass on the floor/base, ensuring they are centered, then use a level to adjust their horizontal position.

3-2. Align the lock hole on the corner bracket with the corresponding hole on the wall and secure it with screws.

3-3. Use a hex wrench to tighten the glass fasteners securely.

Drawings may not exactly define contour of the product.

Installation steps

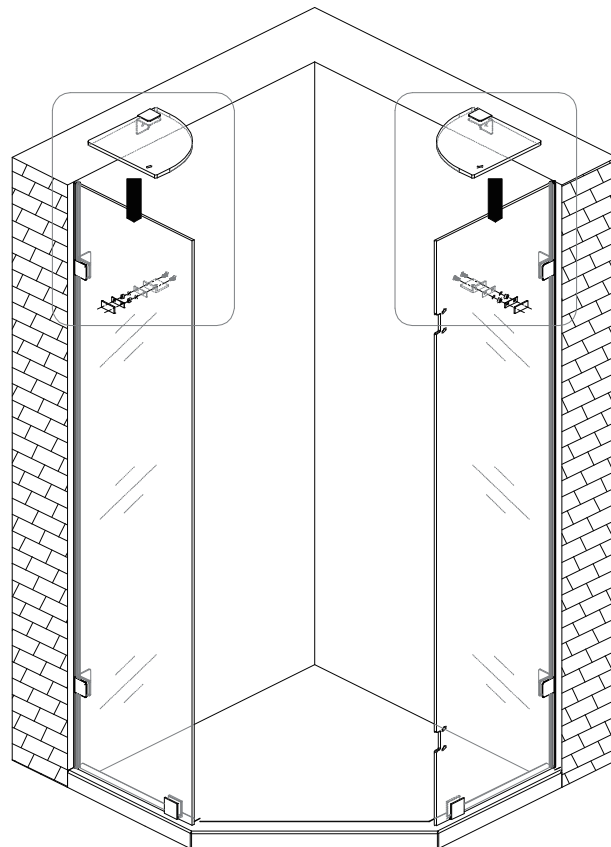
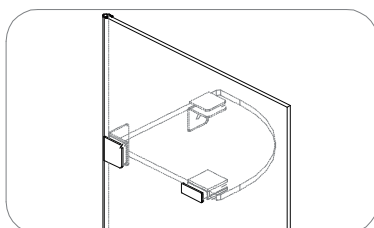
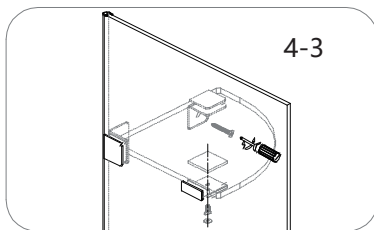
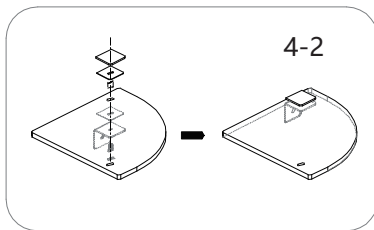
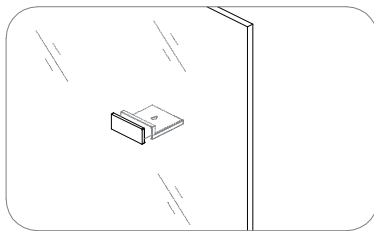
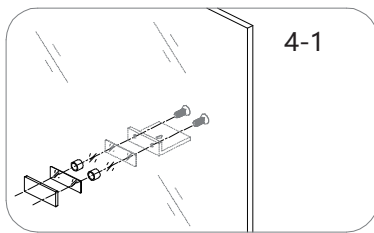
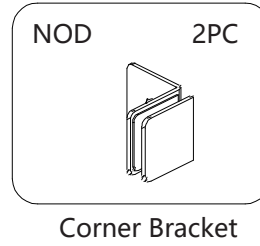
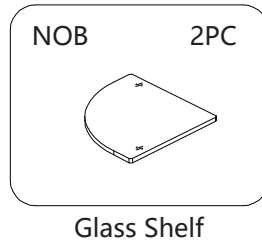
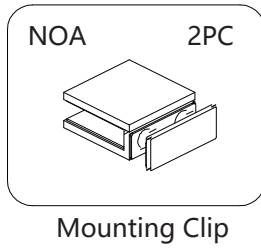

Step 4: Install the glass shelf

- 4-1. Begin by attaching the glass shelf accessories onto the hinge fixed glass and door magnetic fixed glass.
- 4-2. Assemble the shelf glass accessories and attach the corner brackets to the glass shelf.
- 4-3. Attach the assembled shelf glass to the mounting clips and secure with screws.

Drawings may not exactly define contour of the product.

Installation steps

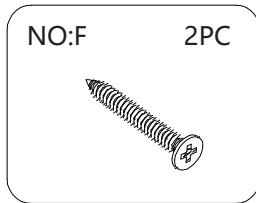

Screw

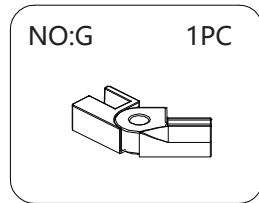

Left Connector

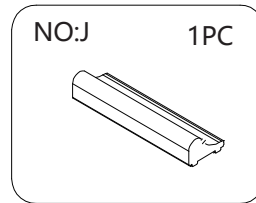

Aluminum Water Stopper

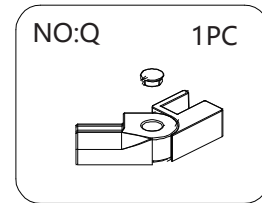

Right Connector

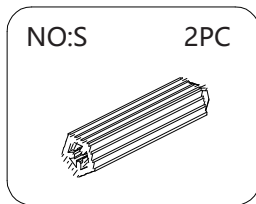

Wall Plug

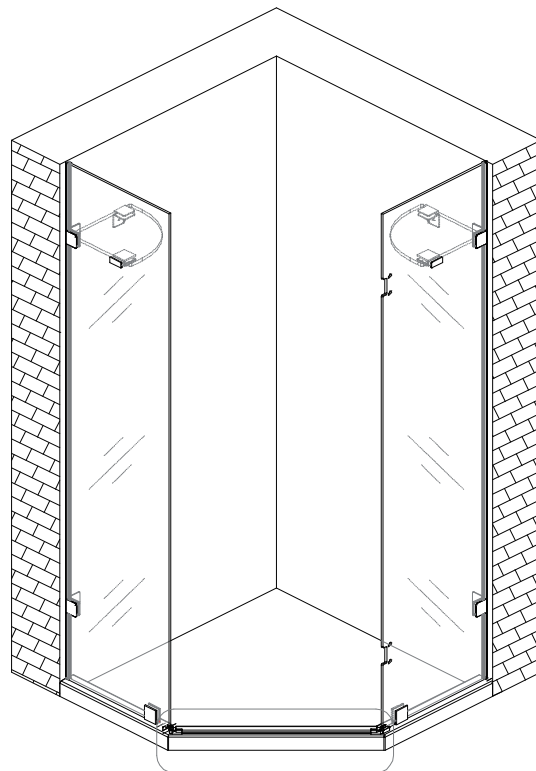
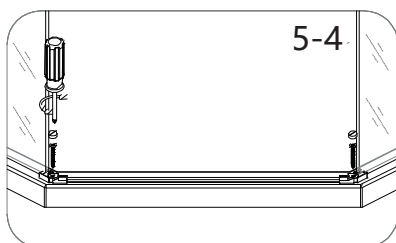
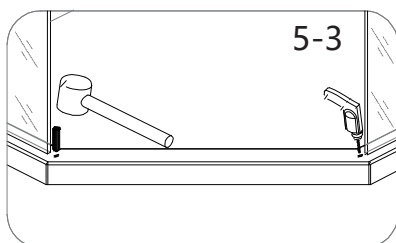
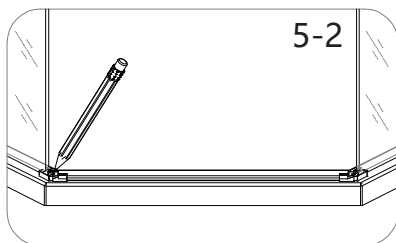
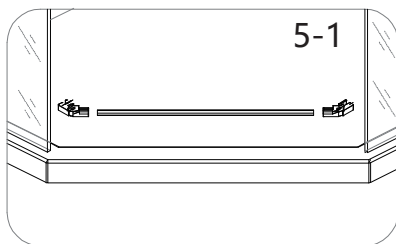

Step 5: Install the water blocking aluminum strip

- 5-1. Assemble and adjust the components, then fix them against the glass and hinge to secure the glass.
- 5-2. Use a marker pen to mark and position the locations.
- 5-3. Use a 6mm diameter drill bit to drill holes at the marked points as per the above steps and insert the wall plug. Ensure the end face of the wall plug is flush with the wall.
- 5-4. Use 4*30 self-tapping screws to secure the water blocking aluminum strip in place.

Drawings may not exactly define contour of the product.

Installation steps

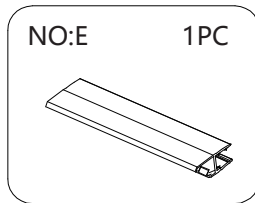

Magnetic Door Strip

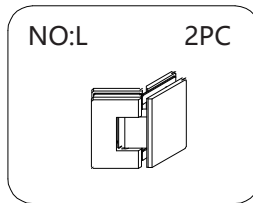

Hinge

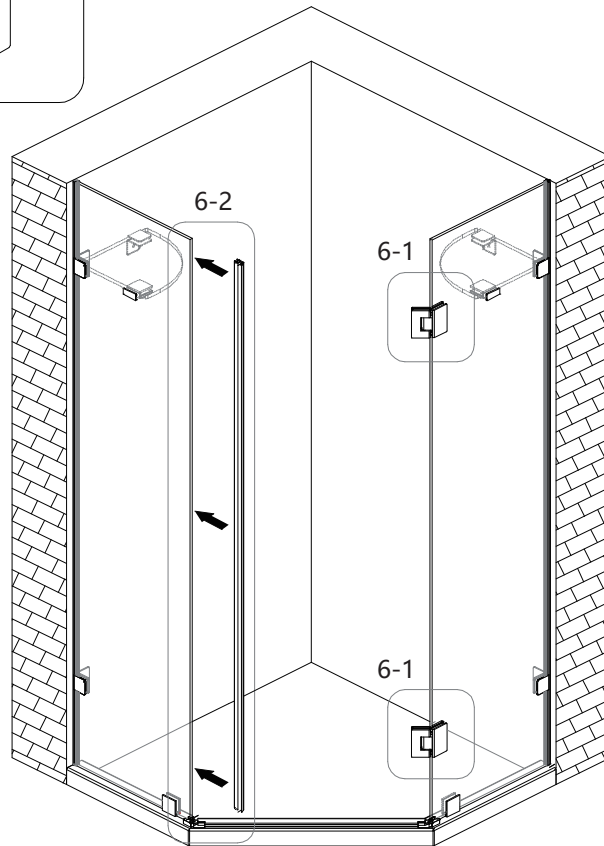
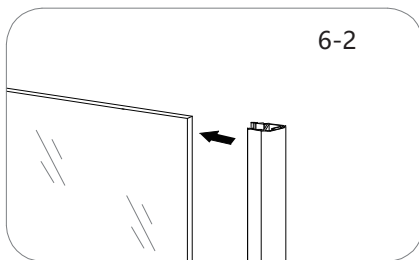
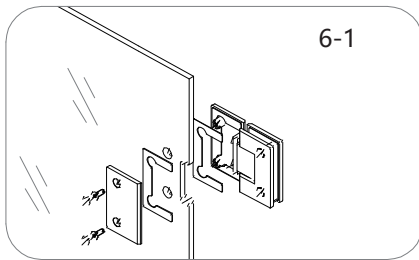

Step 6: Install the hinge and door magnetic strip

- 6-1. Install the two hinges separately on the hinge fixed glass, making sure to pay attention to the orientation of the hinges. Adjust the horizontal position of the hinges to ensure they are level before locking them in place.
- 6-2. Install the door magnet on the large fixed glass, ensuring that the diagonal edge of the door magnet faces inward (towards the interior). Make sure the door magnet is properly aligned for smooth operation.

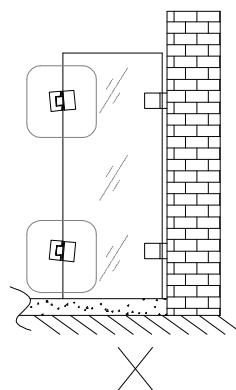
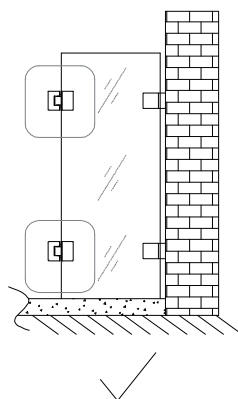

Drawings may not exactly define contour of the product.

Installation steps

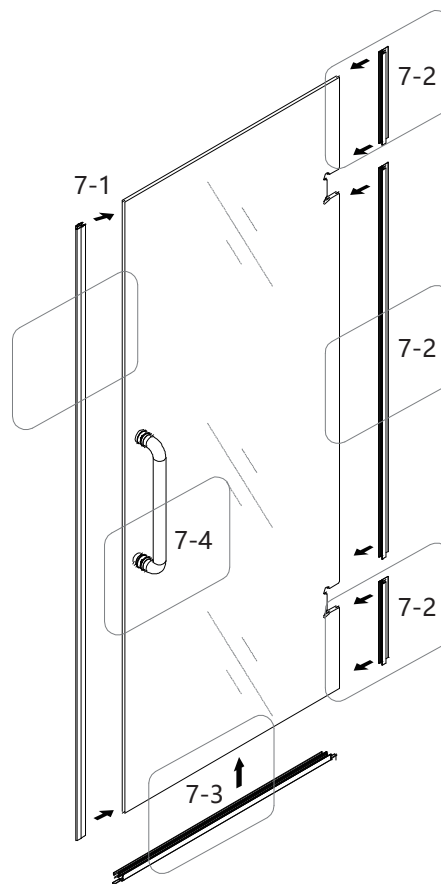
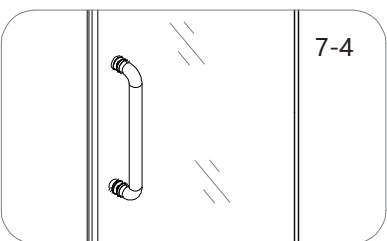
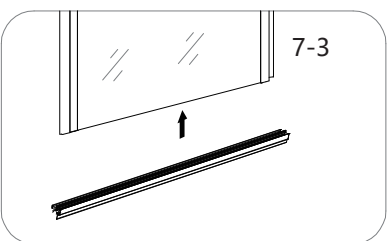
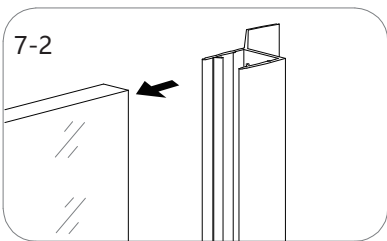
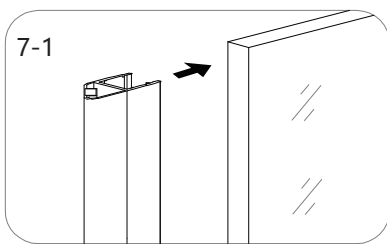
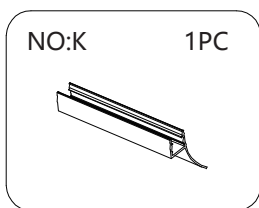
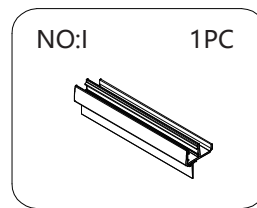
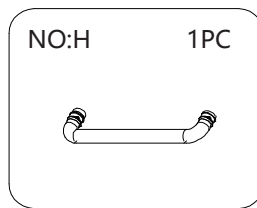
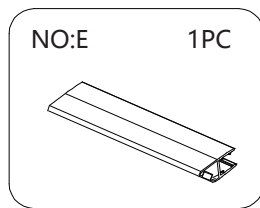
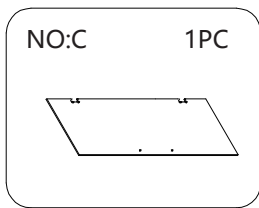

Step 7: Assemble the movable door glass

- 7-1. Install the door magnetic strip, ensuring that the diagonal orientation of the door magnetic strip is correct.
- 7-2. Install the 135-degree soft edge water blocking strip, making sure to align the soft edge in the correct direction.
- 7-3. Install the door glass water guide strip, paying attention to the orientation of the components.
- 7-4. Install the door handle, making sure to orient the inner and outer handles correctly for proper functionality.

Drawings may not exactly define contour of the product.

Installation steps

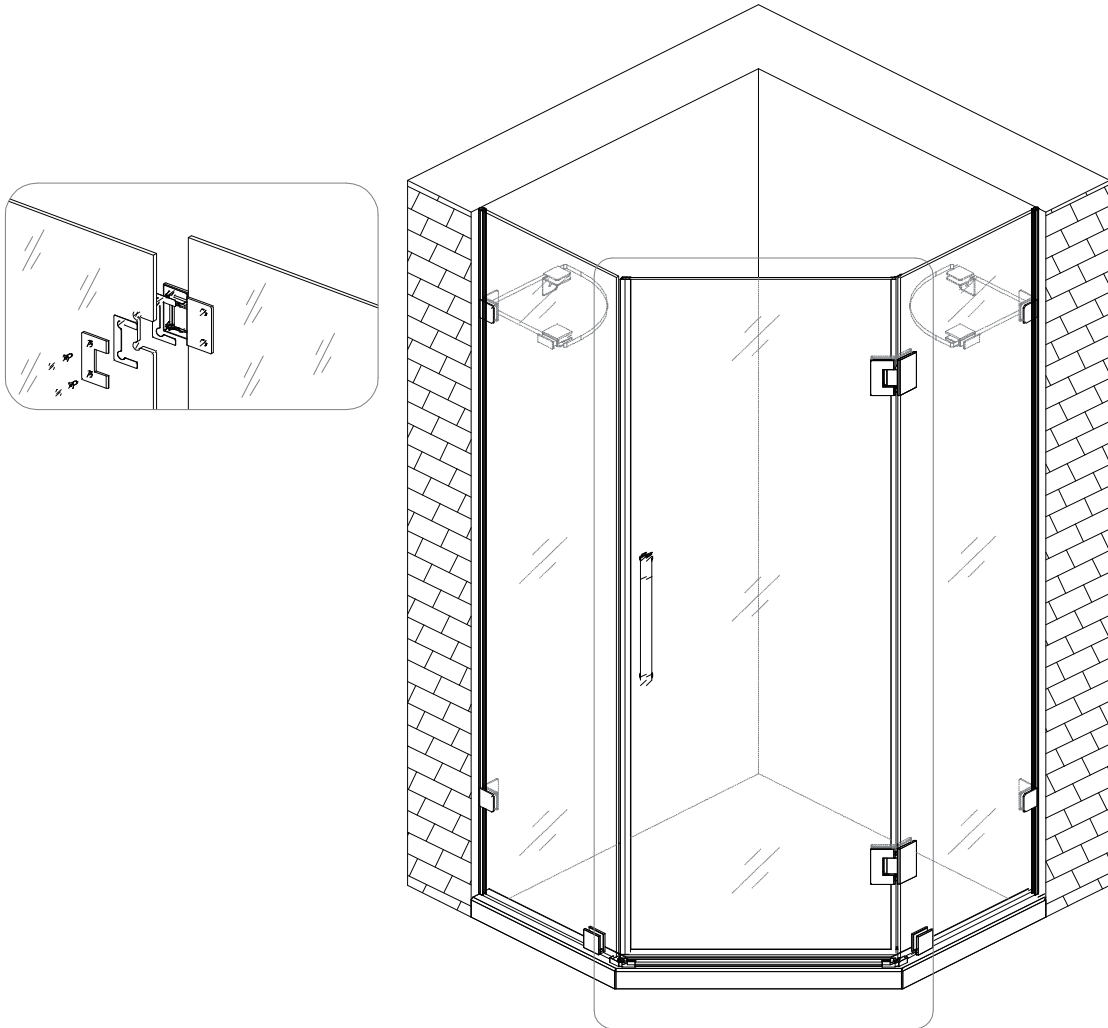

Step 8: Install the door glass

8-1. Carefully install the door glass, ensuring it is aligned vertically.

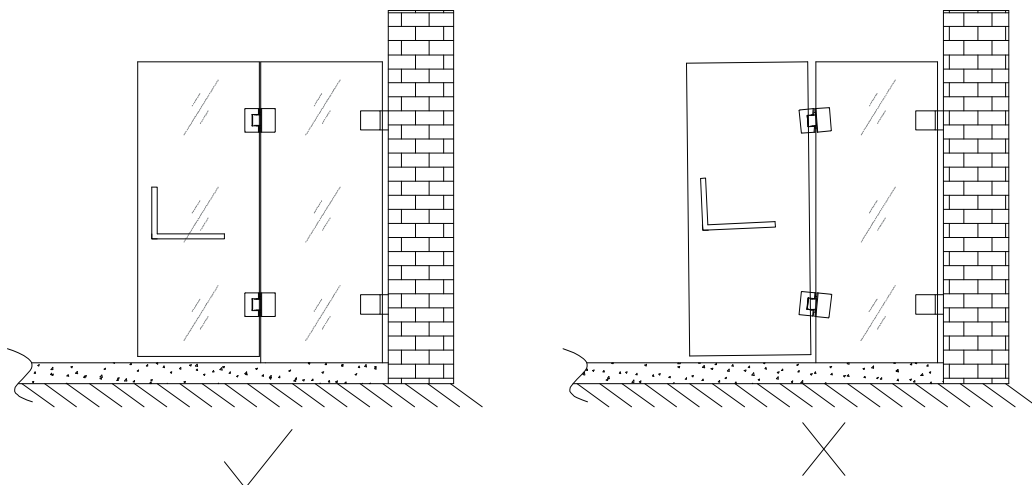

Drawings may not exactly define contour of the product.

Installation steps

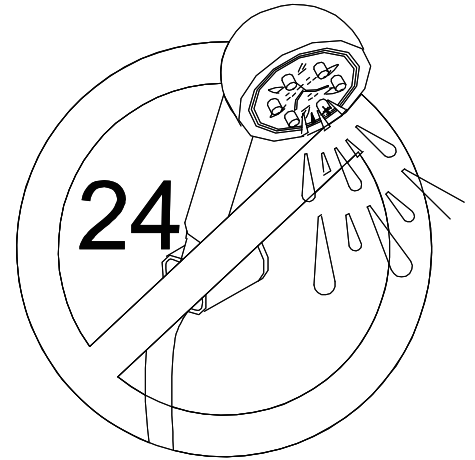
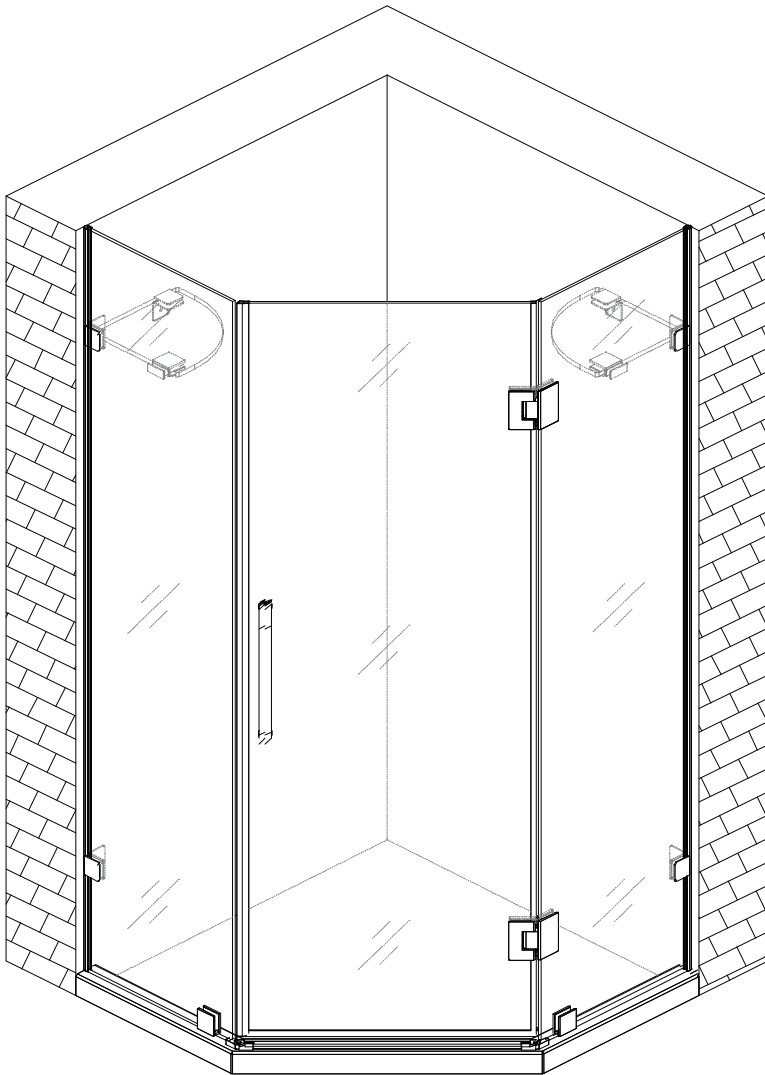

After installation, check for any issues and apply waterproof sealant as needed.

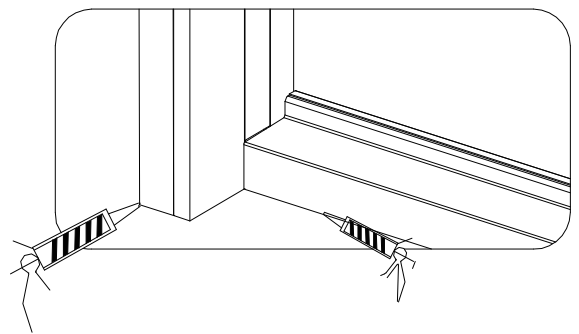

Step 9: Final inspection

- 9-1. Check if the movable door closes properly. If not, verify the vertical installation of the fixed glass and make any necessary adjustments.
- 9-2. Ensure the glass door is level; adjust the lower water-blocking connector if needed. Align it properly to meet standards.
- 9-3. Address any discrepancies in the gap between the glass door and the frame. Adjust the accessories in each part as needed.
- 9-4. If all previous checks are satisfactory, apply glass glue along the top edge of the room for waterproofing. Allow 24 hours for it to set before use.

Drawings may not exactly define contour of the product.

LIMITED WARRANTY COVERAGE

1 YEAR LIMITED WARRANTY

DeerValley products are made with quality materials and excellent craftsmanship to provide the customers a long-lasting product. In the case of any defects in materials or craftsmanship under regular use were inspected in the first one year of delivery, DeerValley will provide replacement parts at no charge, or at its option, replace any product or part of the product that is deemed defective, under normal installation, use, service and maintenance. This warranty applies only to the original purchaser. Proof of purchase will be required in the case of a claim. **SCRATCHES ARE NOT COVERED UNDER WARRANTY.**

The manufacturer warrants this product to be free of manufacture defects during the above mentioned warranty time. Please keep a copy of the original invoice as proof of purchase.

DeerValley will, as its option, (1) repair or replace the defective part(s) or product(s) at no charge; (2) issue a refund of the original purchase price of the product(s) (Valid within 30 days from the date of delivery); or (3) issue a credit to be applied toward the purchase of a new DeerValley product shipping/delivery charges may apply and are in DeerValley sole discretion.

DeerValley recommends the installations to be made by a licensed, professional plumber. DeerValley will not be held responsible for any damage or product failure due to improper installation, misuse, or failure to use a licensed professional. DeerValley is not responsible for any removal or installation cost.

This limited warranty shall not apply to goods which have been subject to accident, negligence, improper installation, product abuse, product misuse, or use of cleaners containing abrasives, alcohol or other organic solvents, whether performed by a contractor, service company, or yourself, are excluded from this warranty.

DeerValley responsibility under this limited warranty is limited to only to replacement parts and no other costs. DeerValley will not be responsible for labor charges and/or damage incurred by installation, repair or replacement, nor for any indirect incidental or consequential damages, losses, injury or costs of any nature relating to this product Except as provided by law, this limited warranty is in lieu of and excludes all other warranties, conditions, and guarantees, whether expressed or implied, statutory or otherwise, including without restriction those merchantability of fitness for use.

RESPONSIBILITIES OF OTHERS

Inspecting the unit prior to installation is the responsibility of the installer or building contractor who acts on behalf of the user. They are responsible for ensuring the unit is free of defect or damage.

Notices are placed on and in the unit and on the shipping carton advising the installer of this responsibility.

In the event of a problem, the unit must not be installed. DeerValley is not responsible for failures or damage that could have been discovered, repaired, or avoided by proper inspection and testing prior to installation.

Damage occurring in transit is the responsibility of the carrier. The user or installer **MUST** open the crate and inspect the unit for damage when it is delivered. If damage is discovered, it must be reported immediately to the seller and the carrier in writing, and an inspection requested. Failure of the carrier to respond should be reported to the seller and the carrier. Your freight claims should be filed promptly thereafter.

LIMITATIONS AND EXCLUSIONS

This warranty does not cover instances of negligence, misuse, abuse, improper installation, carelessness, accident, hard water or mineral deposits, exposure to corrosive materials, misapplication, damages caused by improper maintenance, alteration of the product, or failure to follow care or installation instructions enclosed with your product. The warranty becomes invalid if the DeerValley product undergoes any alterations or if attempts are made to carry out repairs using unauthorized accessories or parts from DeerValley.

DeerValley will not be liable for loss of use of the DeerValley products, inconvenience, or any other incidental or consequential costs, expense or damages. Please note that some states do not allow the exclusion or limitation of incidental damages.

DISCLAIMER

Except as expressly provided, there shall be no warranty or obligation, express or implied, oral or statutory. No dealer or other person has the authority to make any warranties or representations concerning DeerValley or its products. In no event shall DeerValley be held responsible for any such warranties or representations.

WARRANTY SERVICE

NOTE: When requesting warranty, be sure to have the following:

- Copy of original invoice
- Date of installation
- Description and pictures of defect
- Model number or description of model

To obtain warranty service and replacement part, please contact DeerValley Customer Service. DeerValley will determine whether to repair or replace your product, issue a refund, or issue a credit.