



Dream Convertibles®

# MONTEGO

## ASSEMBLY INSTRUCTIONS

---

- Please DO NOT dispose packaging material till you are satisfied with the finished product.
- Place all the parts on a clean and smooth surface such as rug or carpet to avoid the parts being from dirty or scratched.
- Before you begin assembly, please read and follow the assembly instructions step by step process for successful assembly completion.
- if you have any questions or concerns, please stop and call 866-626-7826 or email [customerservice@lifestylesolutions.com](mailto:customerservice@lifestylesolutions.com) for assistance.

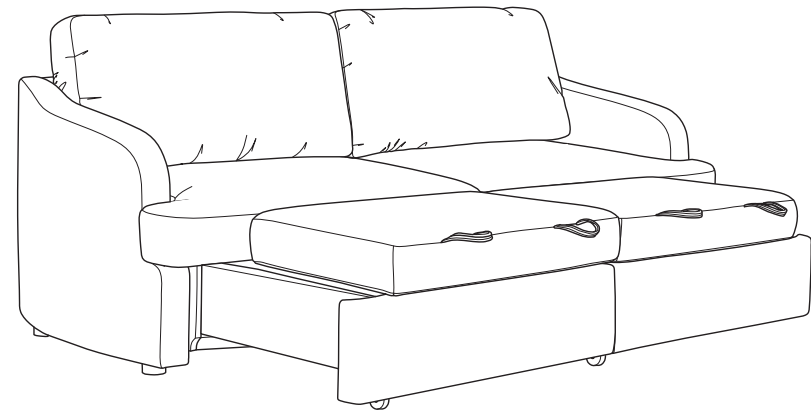
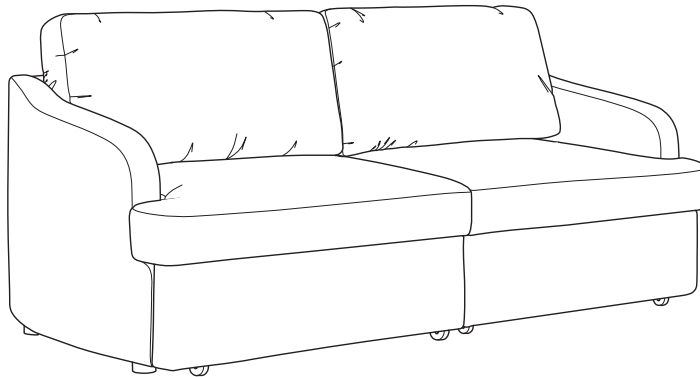

### WARNING

- This product has been designed for seating two average adults, to prevent injury and damages, please avoid miss use or jumping on it.
- This product is designed for home use and not intended for commercial use.
- Children should not be present while assembling the furniture, due to safety concerns.
- Recommended # of people needed for handling: 2 (however it is always better to have an extra hand.)
- THIS INSTRUCTION BOOKLET CONTAINS **IMPORTANT** SAFETY INFORMATION. PLEASE READ AND KEEP FOR FUTURE REFERENCE.

# PARTS

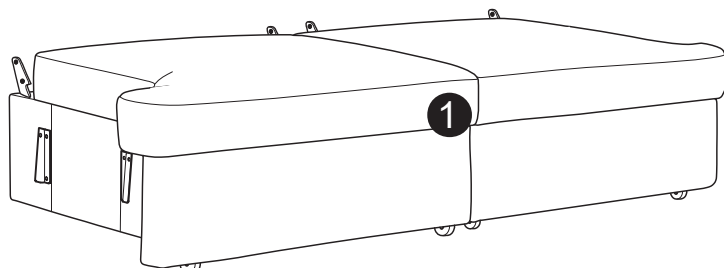

Sofa Body  
QTY:1

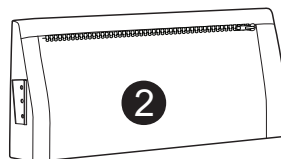

Left Facing Back Deck  
QTY:1

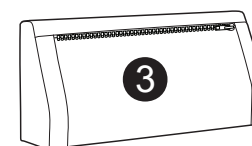

Right Facing Back Deck  
QTY:1

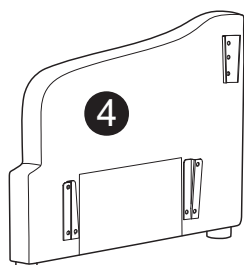

Left Facing Arm  
QTY:1

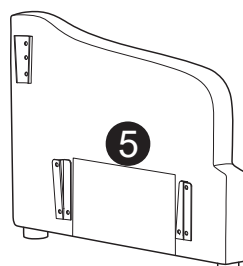

Right Facing Arm  
QTY:1

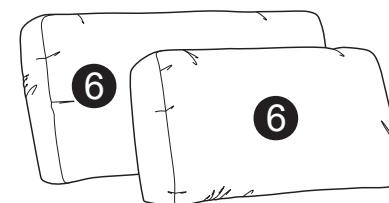

Back Cushion  
QTY:2

**NOTICE TO CONSUMER:**  
Please do not dispose off packaging materials until product are fully tested, to prevent loosing of Parts or Hardware.

---

Step 1 :

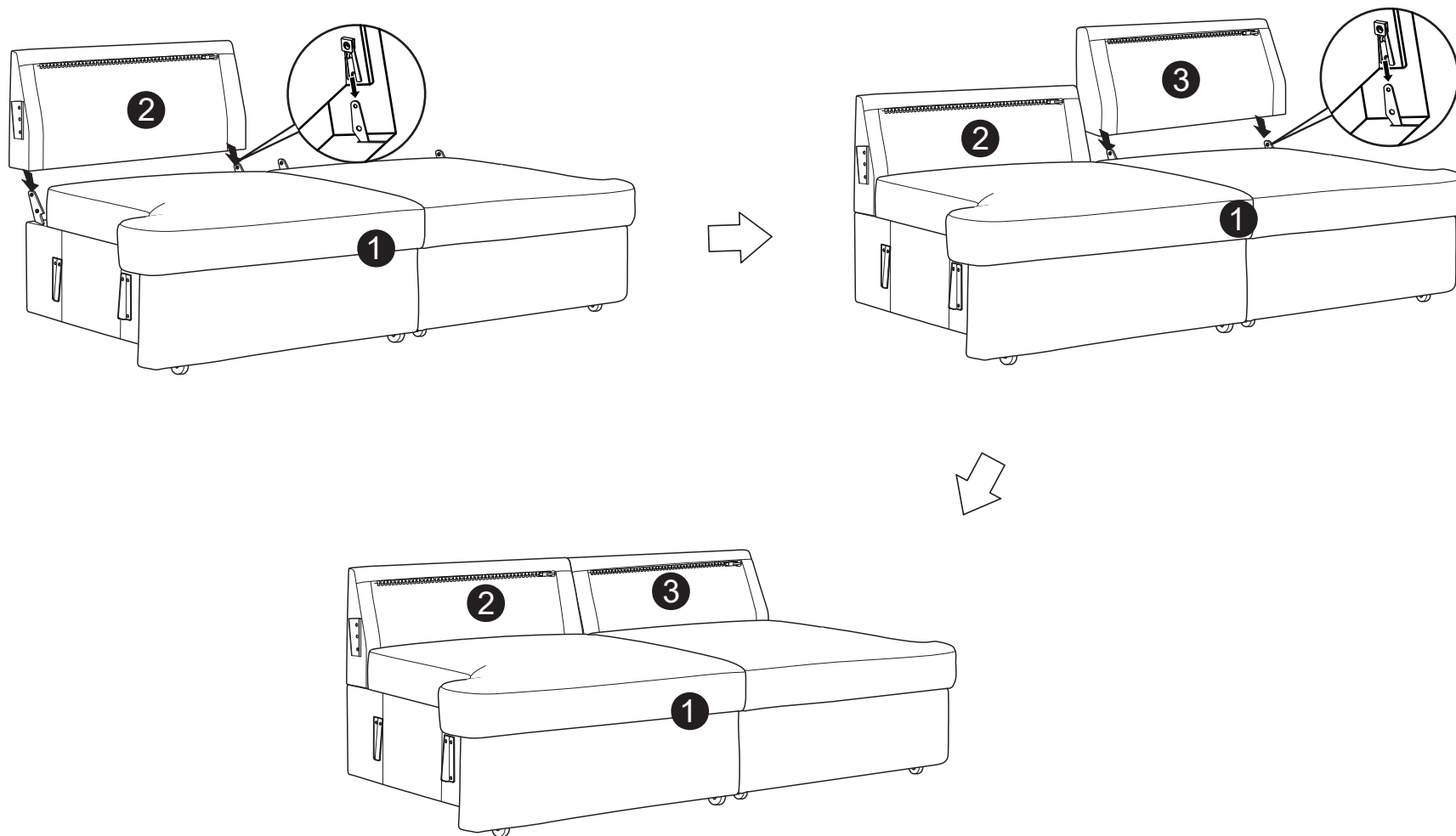

---

Step 2 :

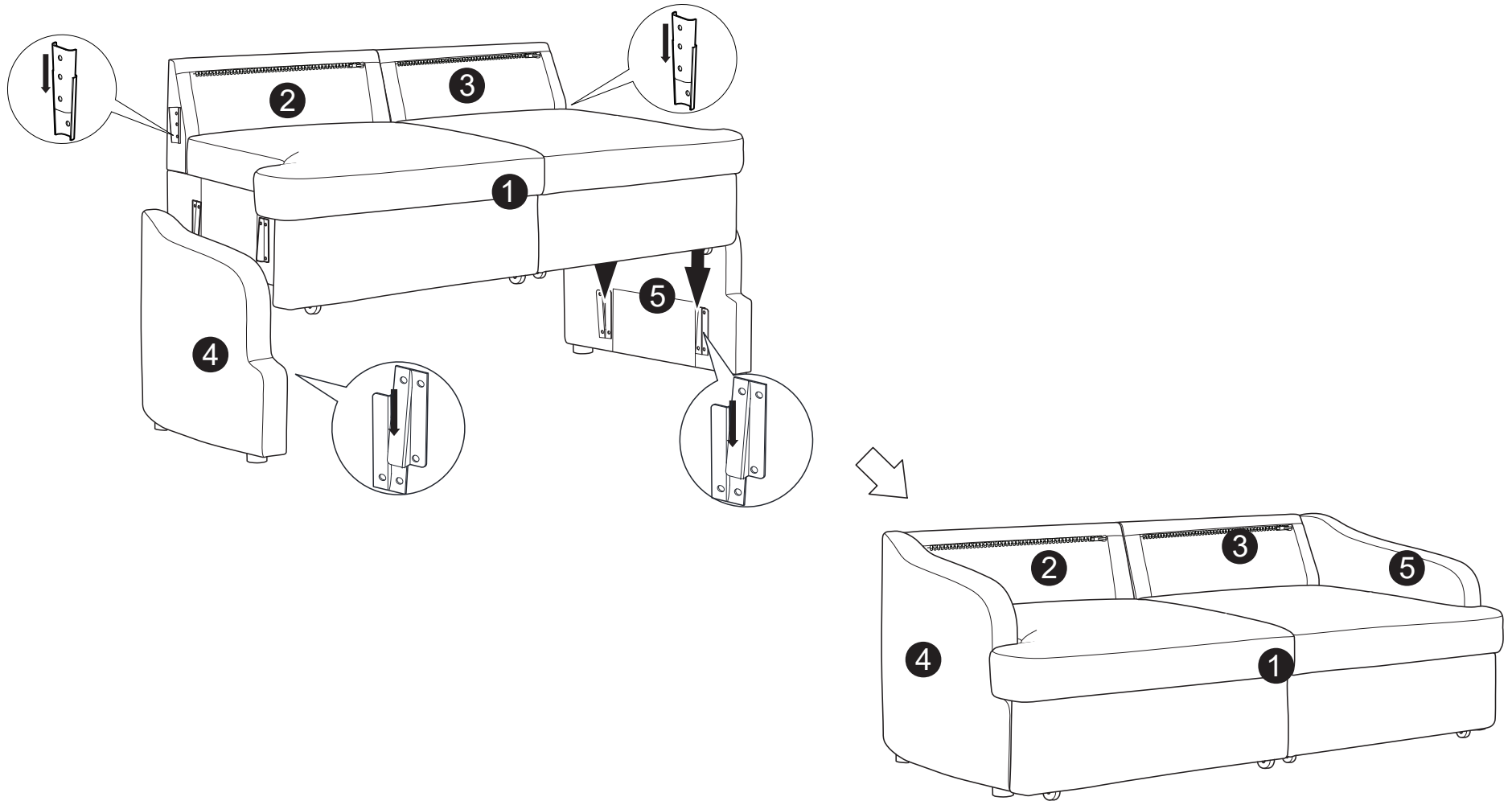

---

Step 3 :

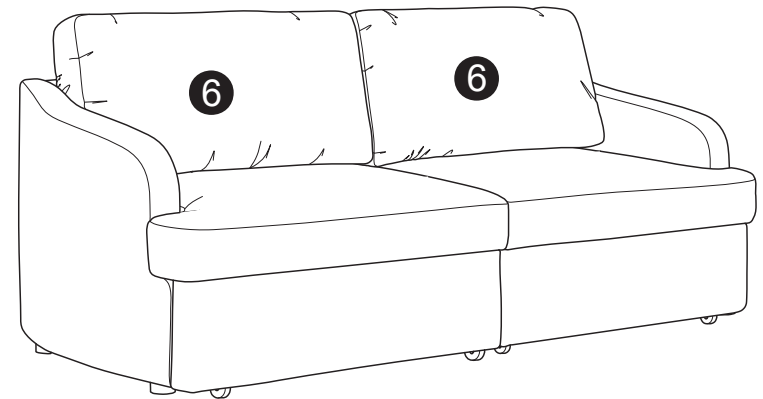
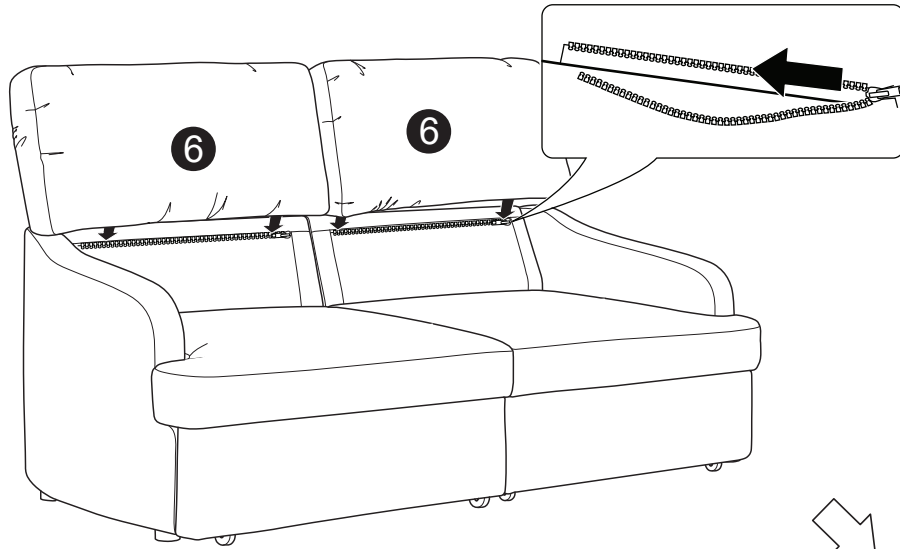

---

## FUNCTIONS :

①

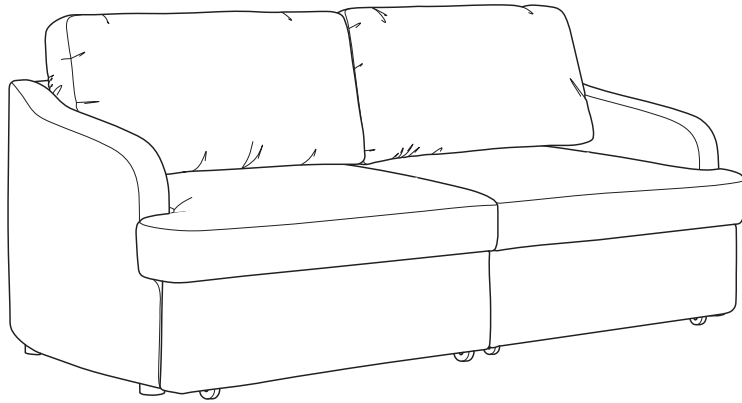

②

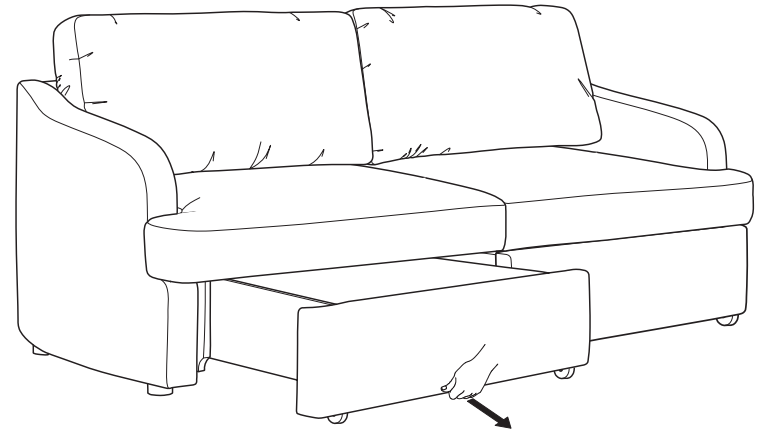

③

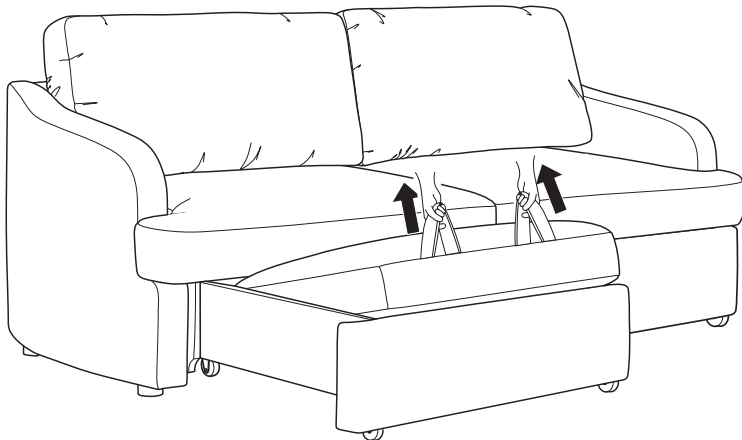

④

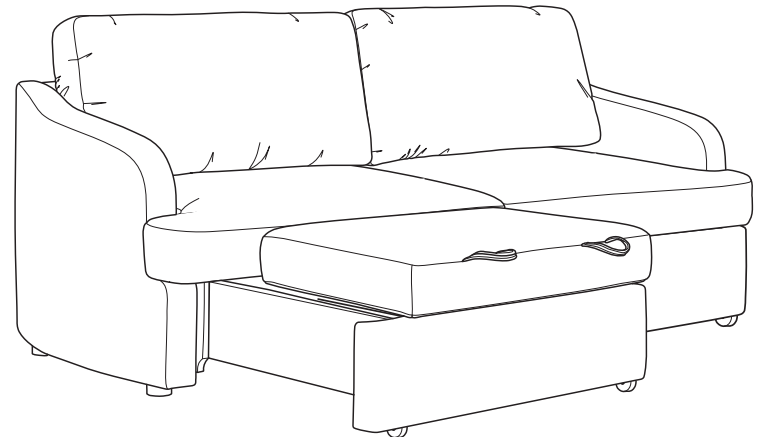

---

# FUNCTIONS :

5

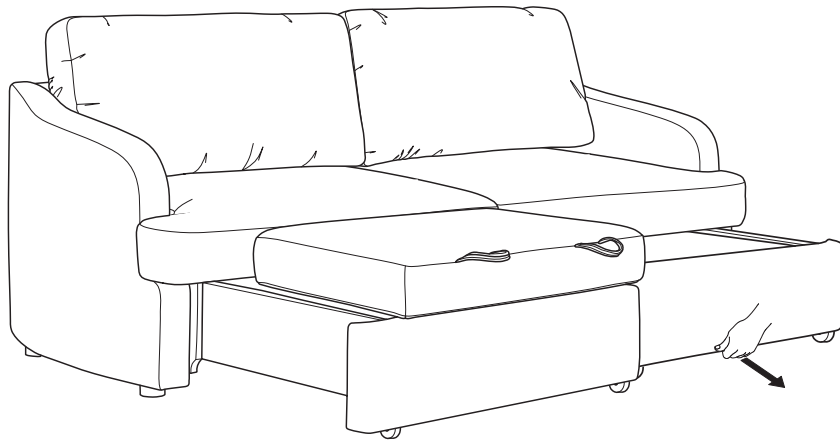

6

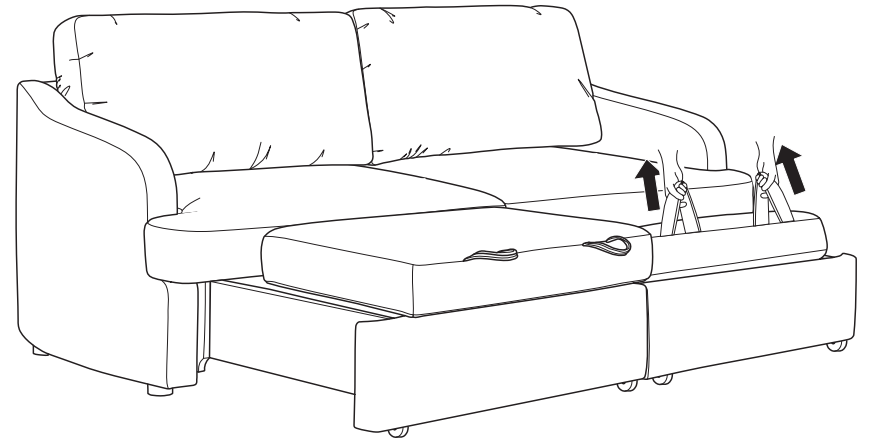

7

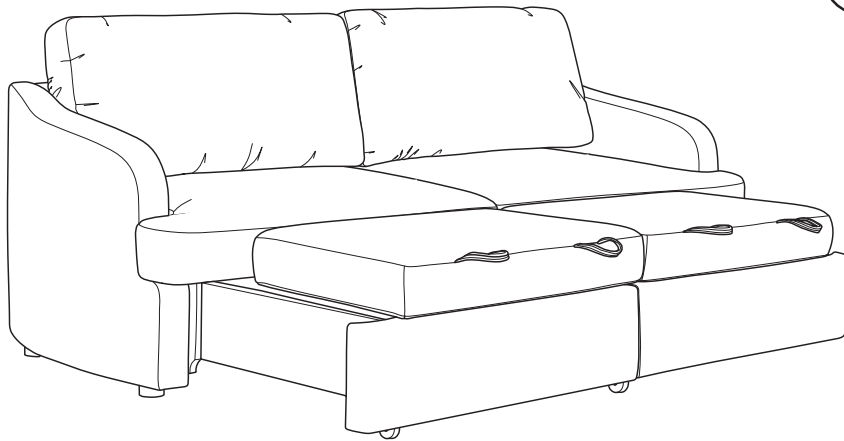

8

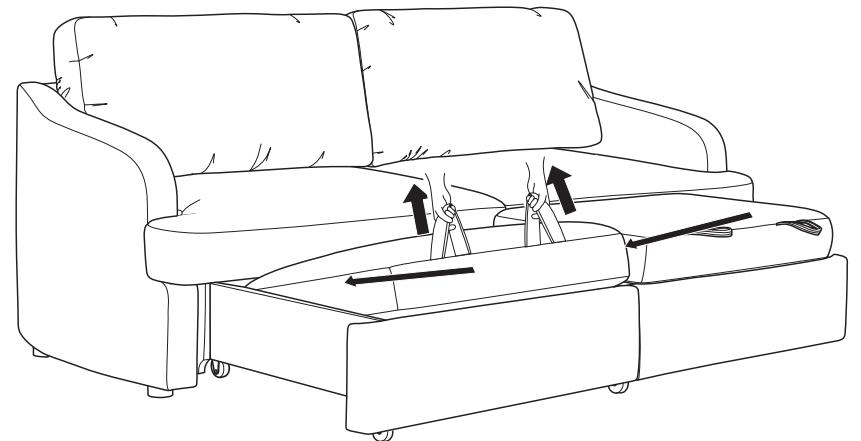

---

## FUNCTIONS :

9

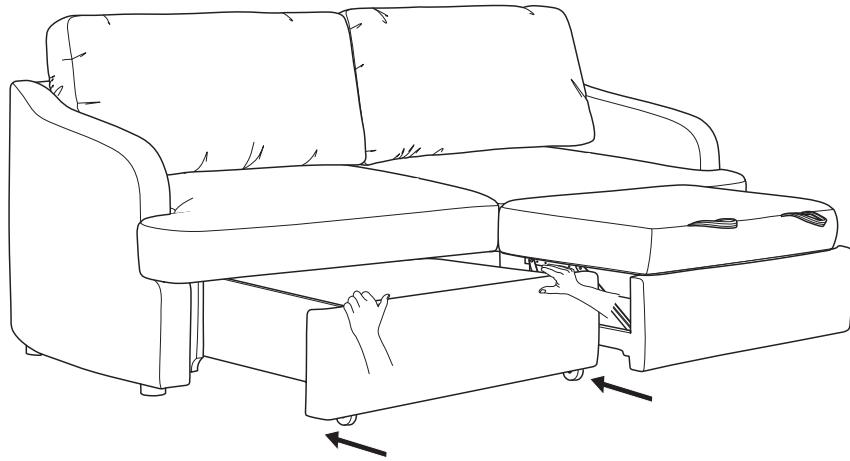

10

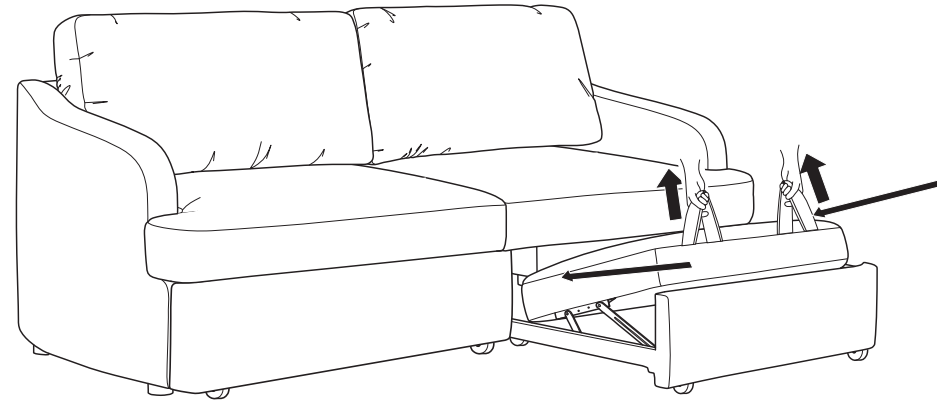

11

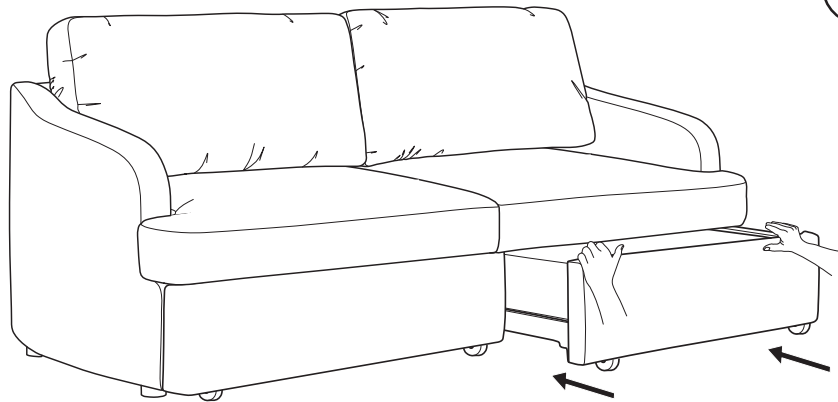

12

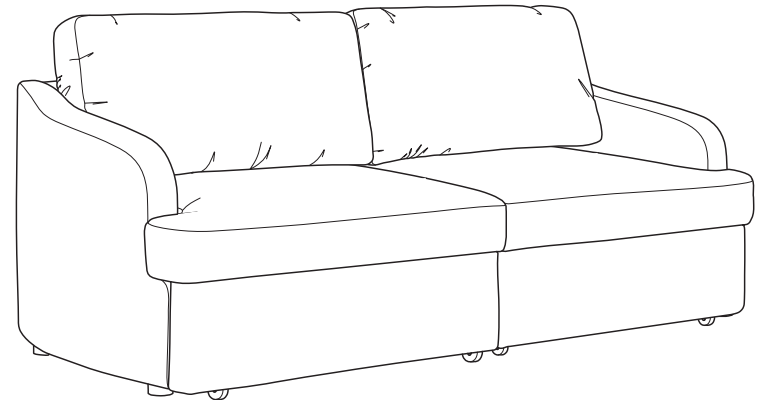

---

# Lifestyle Solutions Ventures, LLC. Warranty

**Lifestyle Solutions Ventures, LLC.** products carry a one year limited warranty pursuant to the terms set forth herein. This warranty is valid only to the original purchaser with proof of purchase, and constitutes the original purchaser's sole and exclusive remedy. Pursuant to this warranty, **Lifestyle Solutions** warrants that all products sold pursuant to this agreement shall be free of any defects in parts and workmanship if used under normal operating conditions.

THIS IS THE ONLY WARRANTY MADE BY **LIFESTYLE SOLUTIONS**. IT IS MADE EXPRESSLY IN LIEU OF ALL IMPLIED WARRANTIES OF MERCHANTABILITY OR FITNESS FOR ANY PARTICULAR PURPOSE.

Should any parts or workmanship prove defective, **Lifestyle Solutions** will, at **Lifestyle Solutions'** discretion, either repair or replace the product at no charge (parts only) to the original purchaser for the duration of the product's full warranty. **Lifestyle Solutions** products are under limited warranty for 1 year from original date of purchase.

At all times, **Lifestyle Solutions** reserves the right to substitute materials with that of a similar quality if the original material is not available. **Lifestyle Solutions** will not be responsible for any freight charges incurred in repairing or replacing products.

**Lifestyle Solutions** DOES NOT WARRANT DAMAGE DUE TO MISUSE OR NEGLIGENCE. This remedy is the original purchaser's SOLE AND EXCLUSIVE REMEDY under the Contract of Sale, and in no event shall consequential damages be recovered by the original purchaser. This warranty gives you specific legal rights, and you may also have rights which vary from state to state.

**Factory Code:**

**P.O. NO.:**

**Product Code:**

**QC NO.:**

(Please keep original receipt with proof of purchase)

**Need assistance?**  
Please call :  
**866-626-7826**  
Or email:  
**customerservice@lifestylesolutions.com**

For prompt, reliable service; please have your assembly manual ready.

Distributed by Lifestyle Solutions Ventures, LLC.  
88 S 3RD ST, PMB# 191. SAN JOSE, 94560 USA  
Email: info@lifestylesolutions.com