

FZU30L



Product family	Freezers
Installation	Built-in
Category	One Door
Cooling type	No-frost
Hinge	Door-to-door
Hinge position	Left



Aesthetic

Aesthetics	Universal	Logo	Silkscreened
Material	Stainless steel	Drawers profile color	Silver
Side material	Metal	Display	TFT
Side color	Steel		

Freezer features



Freezer lighting	Yes
Freezer lighting	LED
Number of drawers	4

Other Freezer features

Ice maker	Automatico
-----------	------------

Other technical features



Display functions	Holiday, Fast-freezing, MultiZone, Sabbath	No. of compressors	1
Fast-freezing button	Yes	Refrigerant gas type	R600a
Power-on light	Yes	Type of compressor	Inverter
Door-open alarm	Yes	Refrigerant quantity	85 oz
Antibacterial Gasket	Yes	Foam agent	Other

Type of temperature control Electronic

Performance / Energy Label

Total volume 119.4 gal





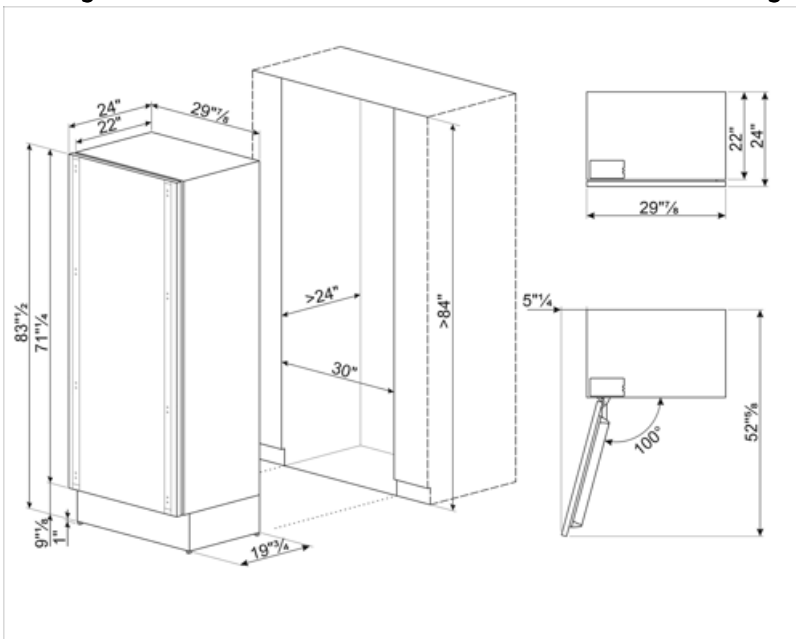

Electrical Connection

Nominal power rating 344 W
 Current 2,5 A
 Voltage 115 V

Frequency (Hz) 50 Hz
 Power cord length 78 3/4 "
 Plug (B) NEMA 5-15P



Symbols glossary

- | | | | |
|--|--|---|--|
|  | Fast freezing: The fast freezing function brings the temperature of the compartment down when activated a few hours prior to usage. |  | Power saving mode: The power saving mode allows you to disable the refrigerator and keep the freezer working. |
|  | LED interior lighting: is a more energy efficient and long lasting way of illuminating the interior of the appliance. |  | Inverter technology: The evolution of Smeg's driers towards more intelligent and environmentally sustainable models has led to the choice of using Inverter technology with heat pumps, which reduces significantly energy consumption. |
|  | Multizone: Multizone compartment can be used as a refrigerator or a freezer compartment. Depending on your needs and eating habits, you can select settings, program the temperature using. |  | No Frost: The No Frost and Frost free systems prevent ice from forming so that no defrosting is required. |