

**ZEAFIVE<sup>®</sup>**

# CARE & MAINTAIN CERAMIC SINK



PRODUCT  
INSTRUCTION  
VIDEO

**MODEL No.ZVS-W001**

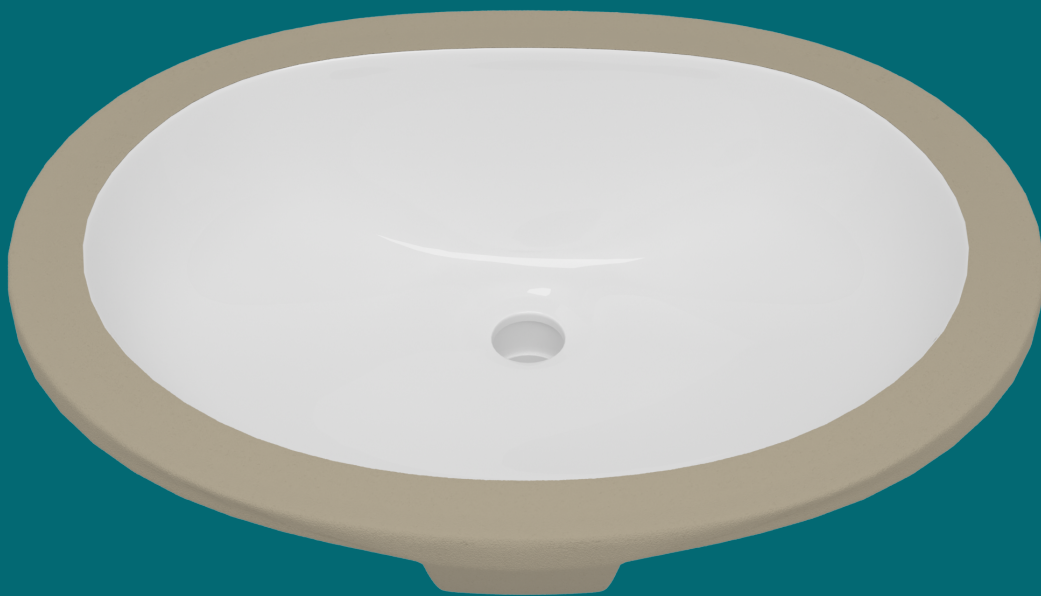

 Email: [service@bestgosupplychaininc.com](mailto:service@bestgosupplychaininc.com)

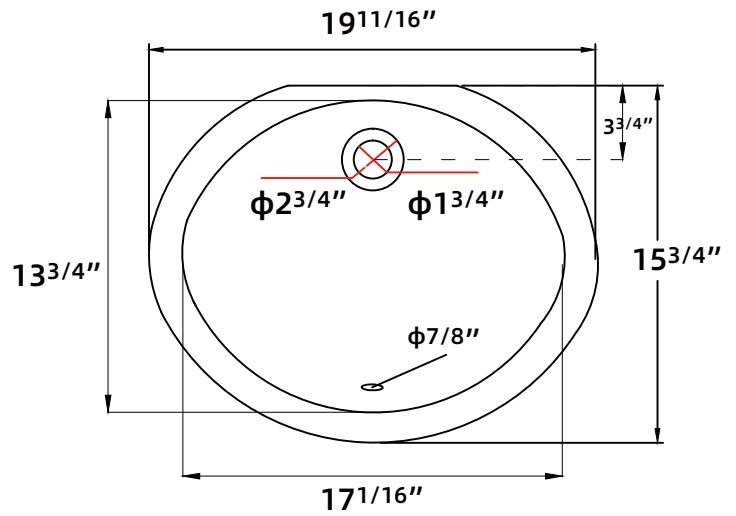

TOP VIEW

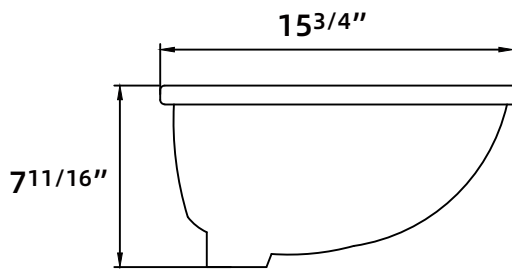

SIDE VIEW

## Features:

- Sleek, seamless design
- Glazed ceramic
- Integrated overflow
- Standard 1 3/4" drain hole

## Installation:

- Undermount

## Colors

- White

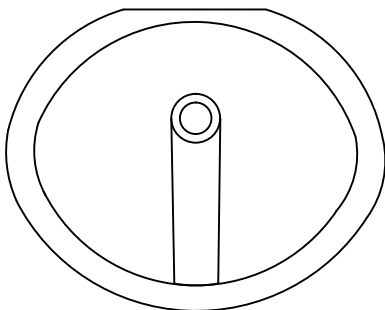

BOTTOM VIEW

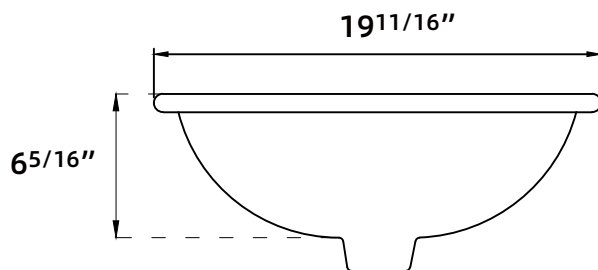

FRONT VIEW

# DELUXE CERAMIC SINK COLLECTION



SKU NO.:  
**ZVS-W001**

---

SKU NO.:  
**ZVS-W101**

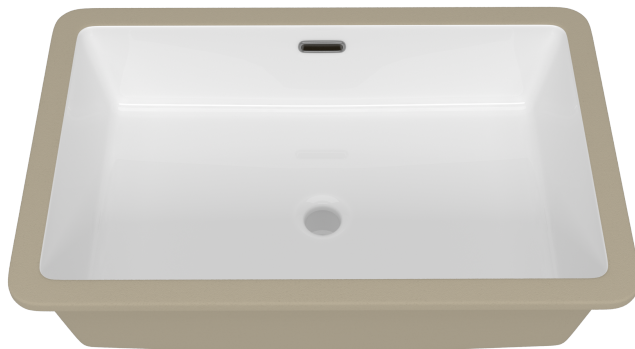

SKU NO.:  
**ZVS-W316**

# INSTALLATION INSTRUCTIONS

## Suggested Tools and Materials:



(Clean Cloth)

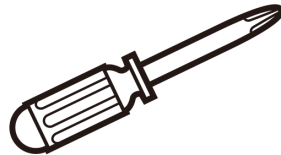

(Cross Screwdriver)

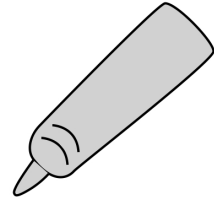

(Silicone Sealant)

### Attention:

1. DO NOT use adhesives or adhesive sealants to install this sink.
2. Sink Only, and without mounting hardware.

## Installation Steps:

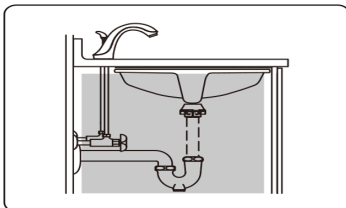

1. Verify the cabinet clearance.

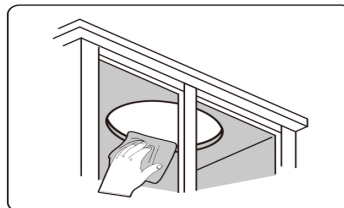

2. Clean the bottom of the countertop and the edge of the sink.

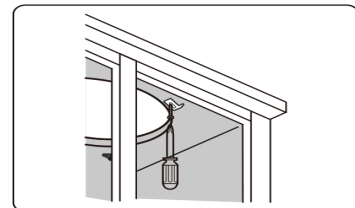

3. Install the clamp loosely.

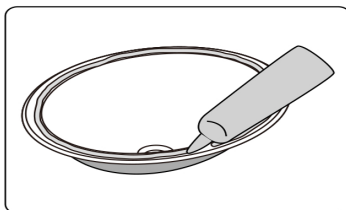

4. Plenty of enough silicone sealant around the surrounding area.

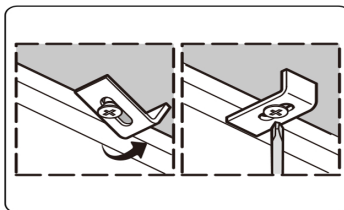

5. Position the sink under the opening. Fix the sink in place and rotate each clamp to the side. Tighten the clamp quickly to secure it.

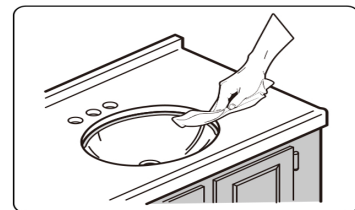

6. Wipe off the excess sealant immediately.

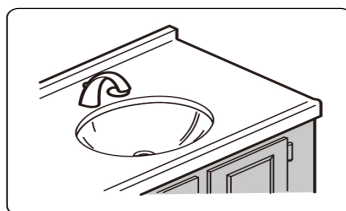

7. Complete the installation of faucet and drain.

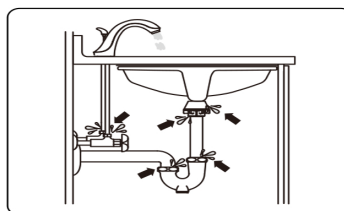

8. Check all connections for leaks when running water into the sink.

# HOME SERVICES



INSTALLATION VIDEO

**Missing Part or Defective?**

Please Contact the Customer Service Team

 Email: [service@bestgosupplychaininc.com](mailto:service@bestgosupplychaininc.com)