

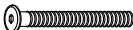



Thank you for purchasing the **BED !**





Before you start, here is some helpful advice:

1. We suggest you spend a short time reading through this leaflet and then follow the simple step by step instructions.
2. Owing to the size and weight of the bed, we recommend that it is assembled by two adults, on a carpeted or padded area, in the room that it is intended for. Approx assembly time: 30 minutes.
3. Please do not use any tools other than those provided or recommended in these instructions.
4. Please do not throw away any of the packaging or the instruction until you have checked all the components and hardware and the furniture is fully assembled. Please ensure that the packaging is disposed of in a safe environmentally friendly way.
5. Assemble all components loosely until advised to tighten. Depending on use, it may be necessary to tighten the components from time to time, so please save the tools that has been provided.
6. Please keep all fitting out of reach of children.

Hardware for Headboard

A		JCBC SCREW M6 X 40MM	x6
B		FLAT WASHER 1/4"	x6
C		SPRING WASHER 1/4"	x6
D		M4 ALLEN KEY (BALL SHAPE) LONG	x1
E		BOLT BASE GLIDE M6 x 23(C83)	x2

Hardware for Bed Frame and Legs

F		JCBC SCREW M6 X 35MM	x2
G		JCBC SCREW M6 X 40MM	x6
H		SPRING WASHER 1/4"	x8
I		FLAT WASHER 1/4"	x8

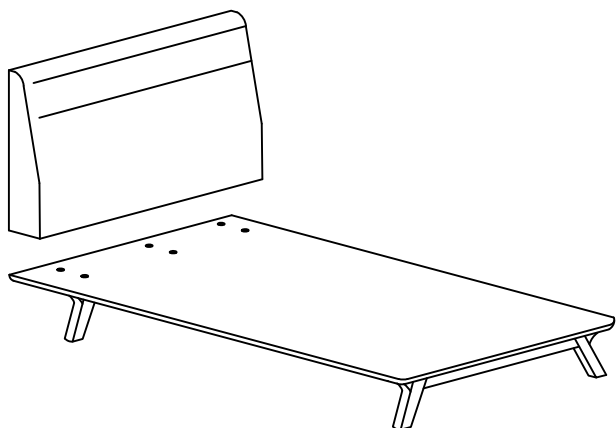

Component :

1- HEADBOARD

2- LEGS

3- MATTRESS PANEL

4- WOODEN SUPPORT

