











# Assembly Instructions

Before you commence the assembly process we recommend that you read these instructions thoroughly beforehand to familiarise yourself with the assembly process and to also check that you have the correct components. If for any reason you need assistance, you can find our contact details on the final page of these instructions.

We highly recommend that any assembly is carried out on an open flat, level surface if possible with sufficient space.

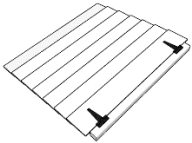
<b>Tools required:</b>	10mm spanner/socket, No2 Pozidriv screwdriver (or electric driver), 2 x 25mm wooden spacer blocks (included).
------------------------	---------------------------------------------------------------------------------------------------------------

## Components

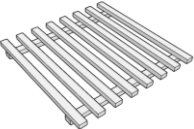
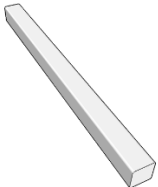
16 x Short screws 6 x Long screws	Latch keep & 10 black screws	1 x Prop fixing	1 x Left panel	1 x Right panel	1 x Back panel
					
1 x Door	1 x Lid assembly	1 x Prop	1 x Finishing strip	1 x Metal bar	1 x Chain
					
1 x Shelf	2 x Shelf rail				
					

### Step 1



Begin by arranging the left panel (the one with the small wood block attached to the front post) and the back panel at 90° to each other, with the back panel raised up on the spacer blocks by approximately 25mm. Use 3 x shorter green screws to secure as shown.

### Step 2

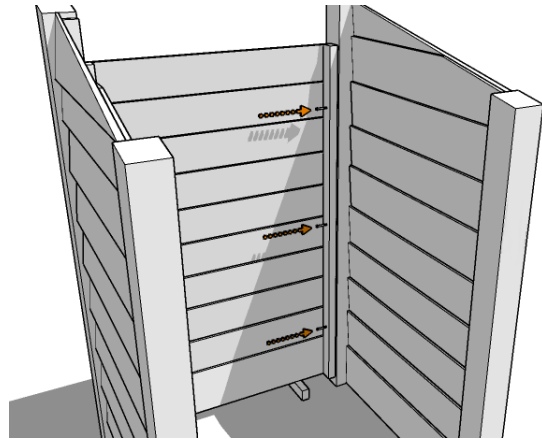

Now add the right hand panel, fixing in the same way with 3 x shorter green screws.

### Step 3

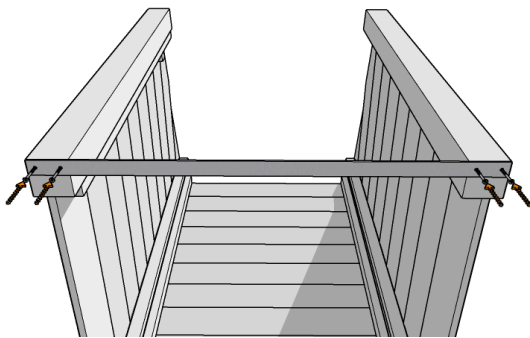

Carefully lay the assembly on its back and attach the metal bar to the front bottom edge of the 2 front posts as shown, securing in place with 2 x shorter green screws per post.

### Step 4

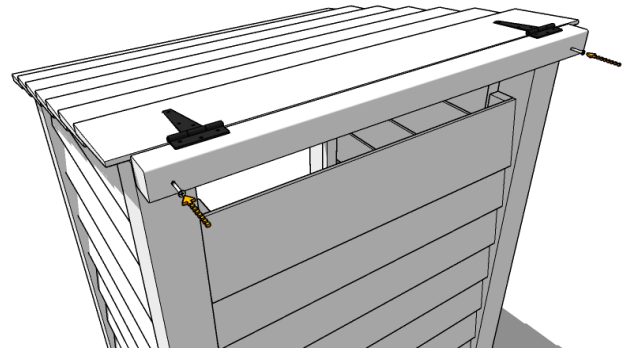

Stand the assembly back up and lower the lid assembly into place so that the hinge bar is centred across the rear posts and fix into place with a shorter green screw into each post.

## Step 5

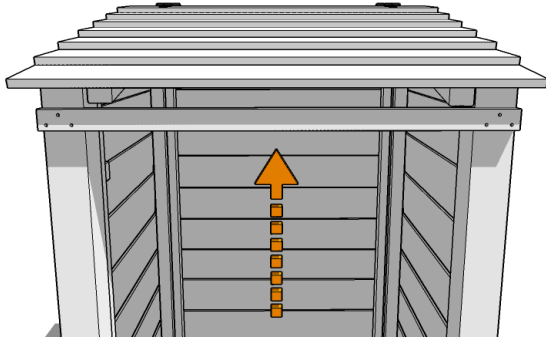

Returning to the front of the store, place the finishing strip against the 2 front posts as shown with the screw holes configured to create a triangle and slide it upwards...

## Step 6

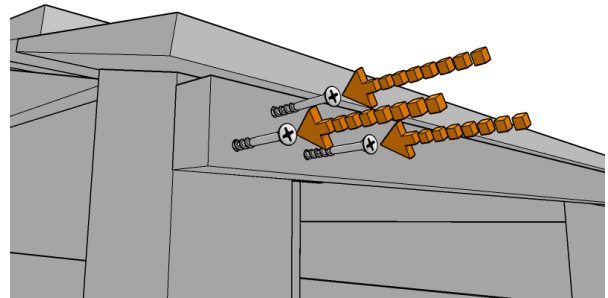

...until it is just touching the underside of the lid. Now fix both ends in place with 3 x shorter green screws per post.

## Step 7



Set one of the shelf rails against the inner face of a side panel, spanning the vertical battens, at a suitable height to accommodate your recycling box. Ensure it is level (use the horizontal slats as a guide if necessary) and fix in place with a longer green screw though each end into the

## Step 8

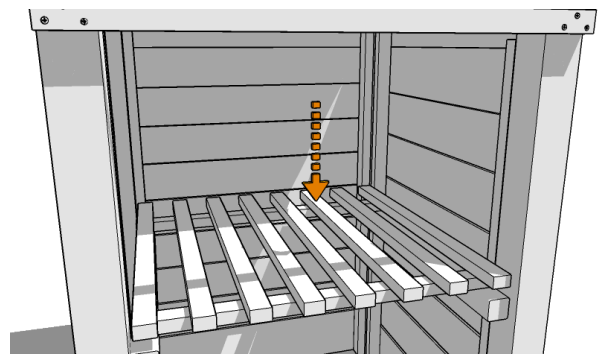

...then repeat for the other side ensuring the opposite rail is at the same height. Now drop the shelf into place.

## Step 9

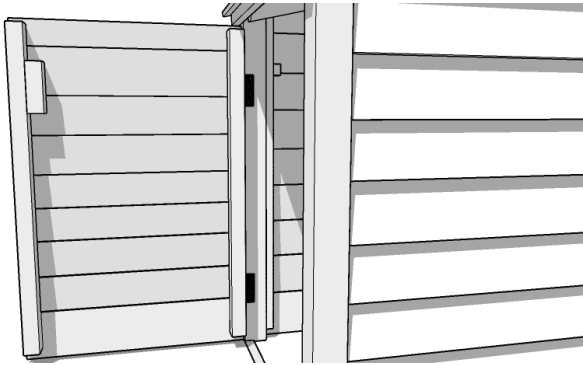

Align the door (hinge side on the left) so that the top edge clears the underside of the finishing strip by approx 10mm and each hinge leaf sits flat against the post with the knuckles resting against the front edge of the post. Secure the hinges in place using 8 x black screws.

## Step 10

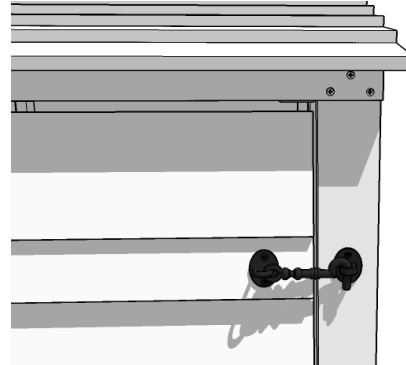

Position the cabin latch keep on the post and aligned horizontally with the latch as shown. Secure in place with 2 x black screws.

## Step 11



Your Morcott Single Recycle Store is now complete.