

MANUAL GUIDE

30inch

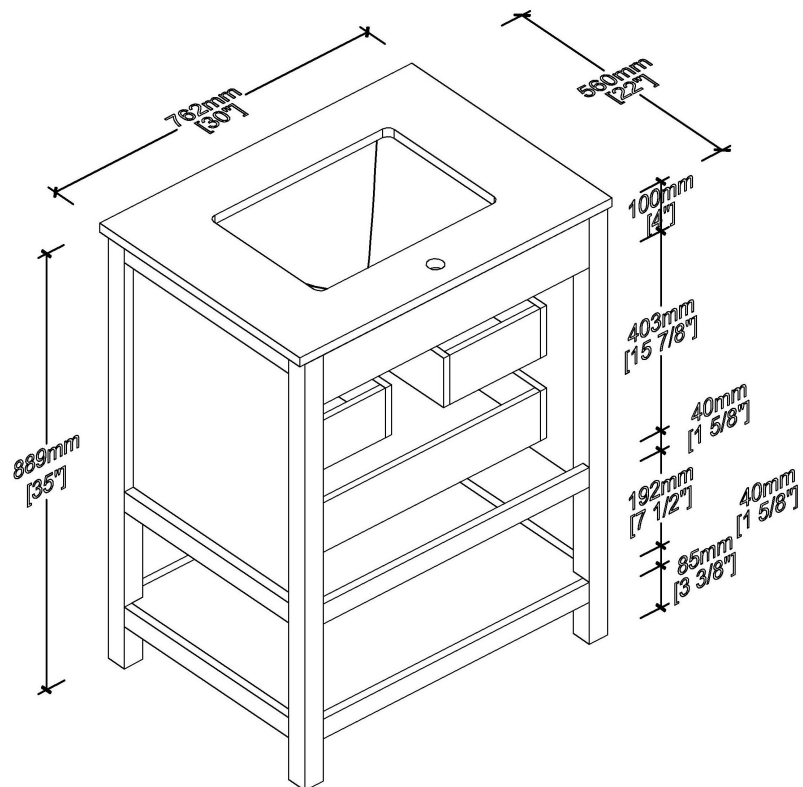
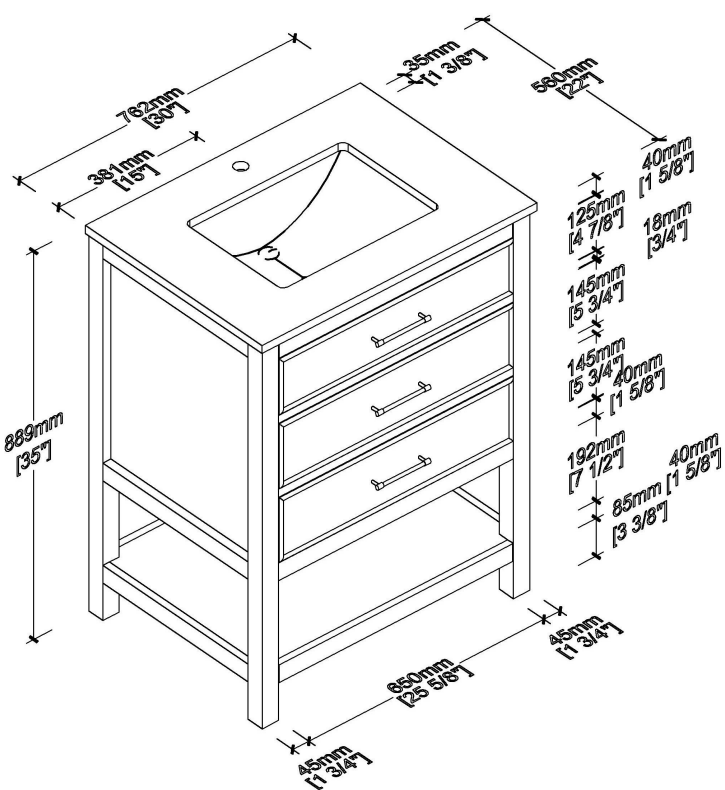
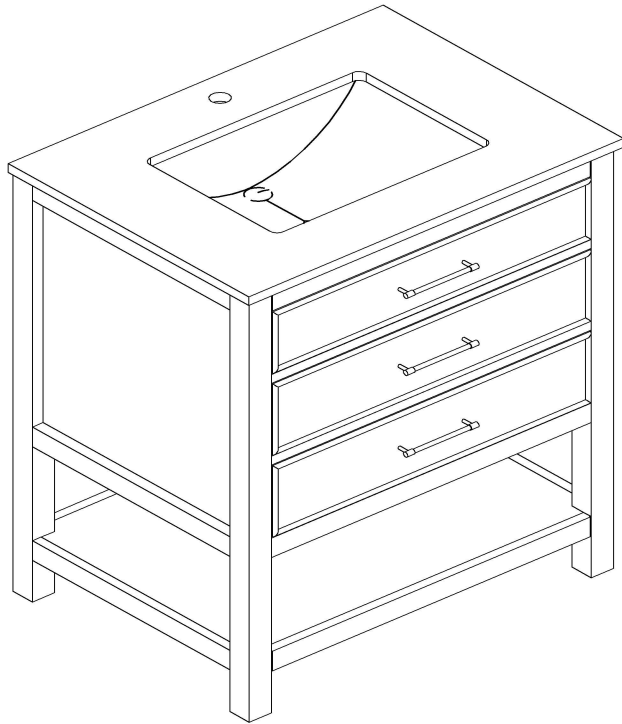

PRE-ASSEMBLY

To ensure your installation goes smoothly, please read the following instructions carefully before your installation.

1. Removing your old vanity (if applicable). Turn off the electricity and water supply before you start. Then disconnect all lines to the sink and disconnect appliances.
2. Evening out walls and floor Flat, level surfaces are important. Unevenness can cause your vanity to become misaligned resulting in twisting of the cabinet. Repair any uneven areas by reducing high spots or shimming low spots.
3. Check all parts and review all tools (not included) make sure you have all prepared before your installation.

TOOLS REQUIRED (Not included)



Sealant

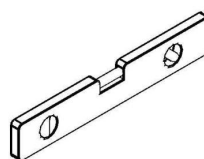

Level

PACKAGE CONTENTS

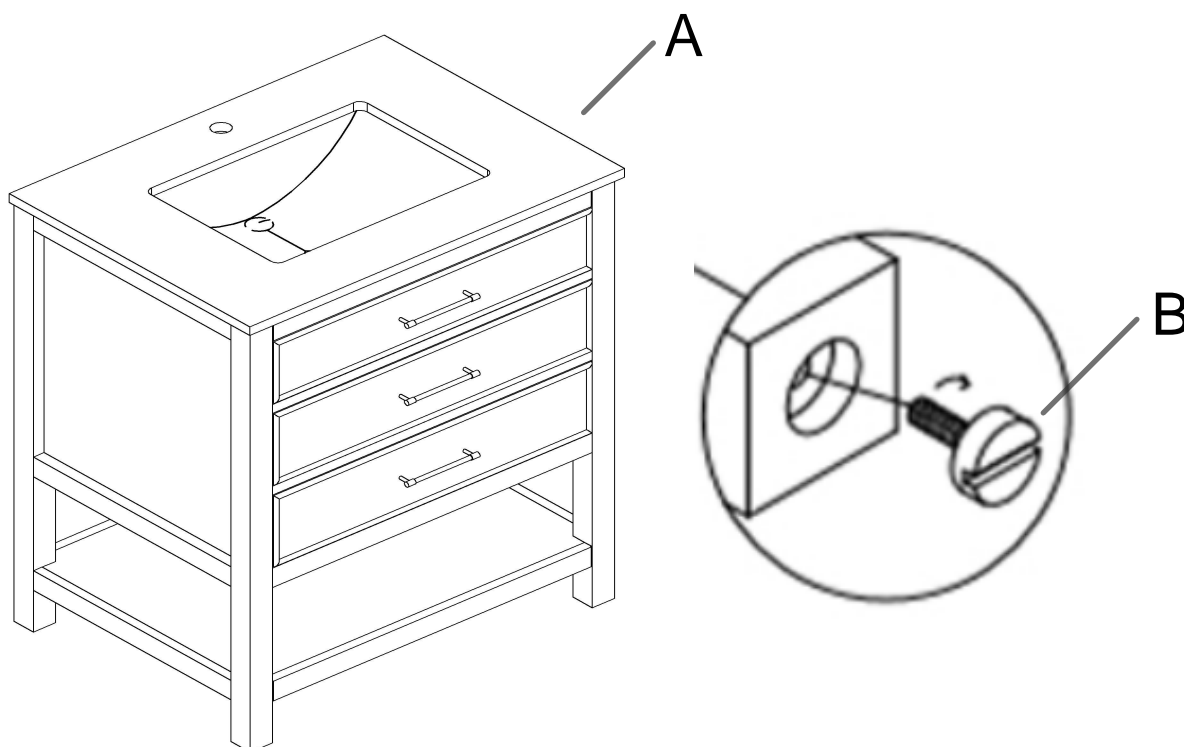

Part	Description	Quantity
A	Vanity with top	1
B	Leg Levelers	4

ASSEMBLTY

1. Lever the vanity

*Use a level and adjustable leg to keep the cabinet level.

2. Position the vanity

*Place the vanity in position.

Ensure the vanity is flush against to the wall.

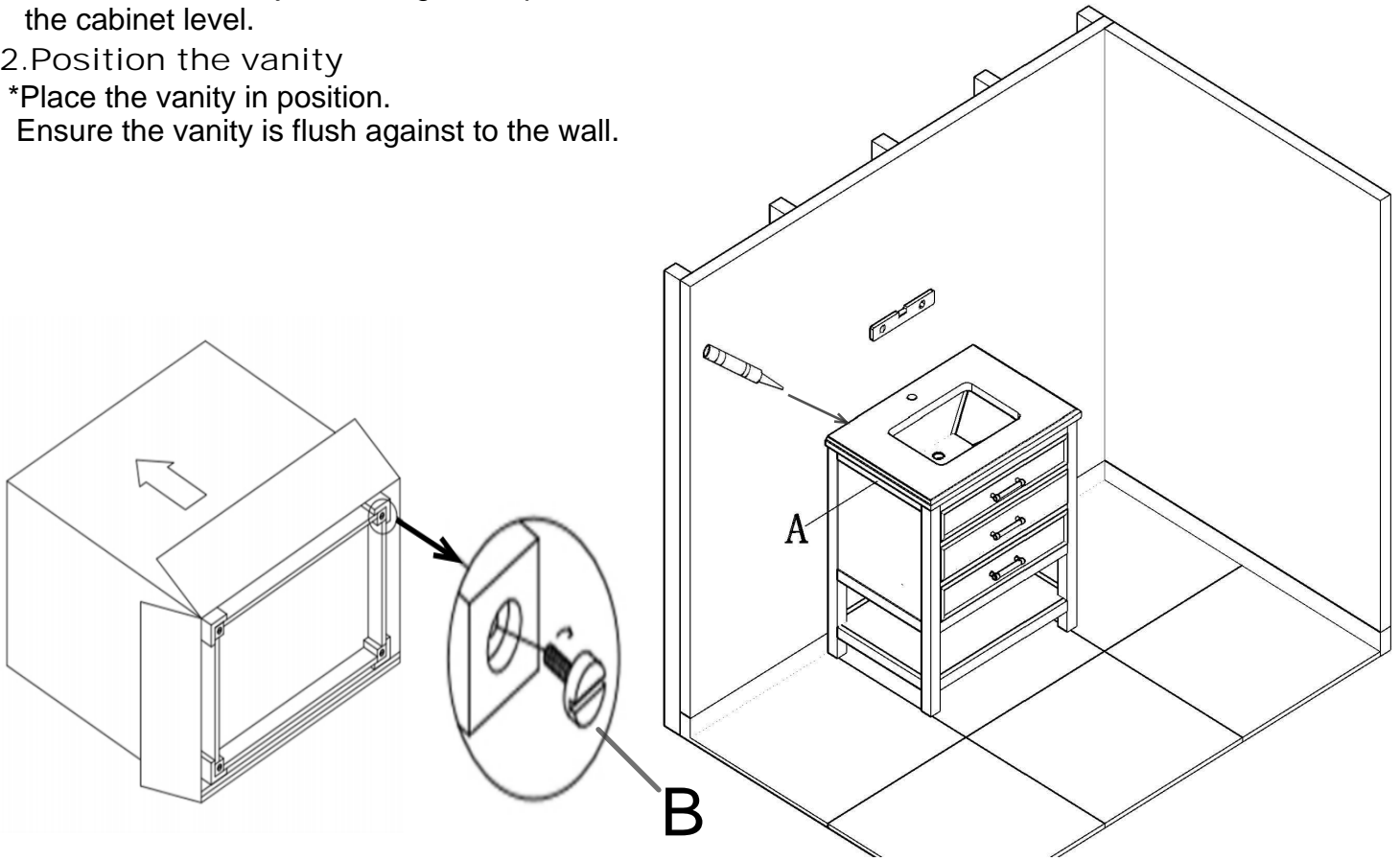

3. Seal the vanity

*Apply sanitary silicone sealant between vanity and the wall. Let it sit and dry for 24 hours.

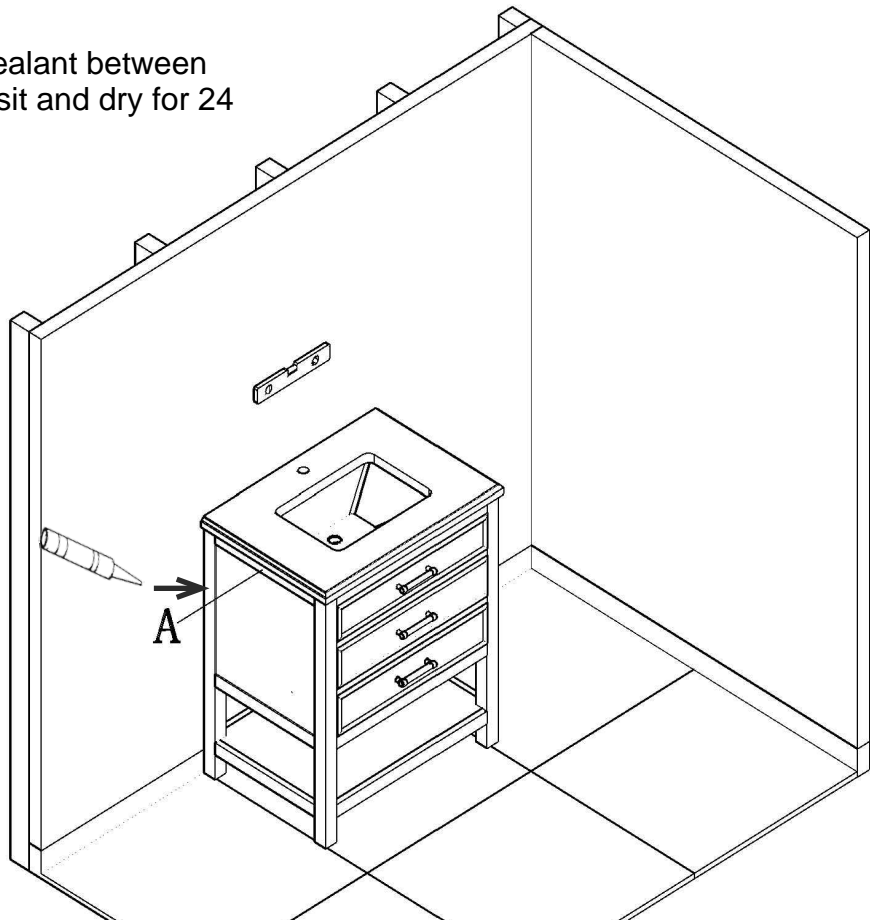

DRAWER REMOVAL AND RE-INSTALLATION INSTRUCTIONS

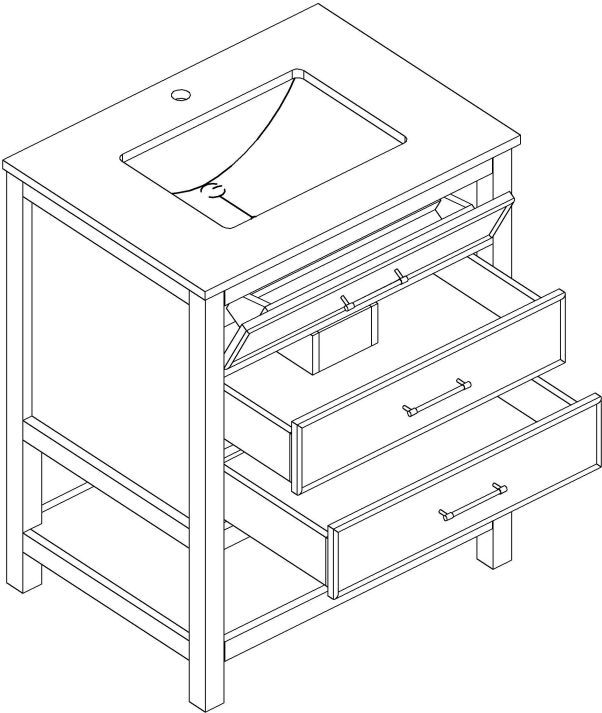

REMOVAL

RE-INSTALLATION

