

Ceiling Fan

High-end design of the ceiling fan brings wonderful experience, life is better because of it.



OWNER'S MANUAL

READ AND SAVE THESE INSTRUCTIONS



WARNING

WARNING: To avoid fire, shock and serious personal injury, please read the following instructions carefully.

Important Safety Instructions

1. Read all instructions and safety information before installing your new fan. Review the accompanying assembly diagrams.
2. Before installing the fan, disconnect the power by removing fuses or turning off circuit breakers.
3. Make sure all electrical connections comply with local codes, ordinances, or National Electrical Codes. Hire a qualified electrician or consult a do-it-yourself wiring handbook if you are unfamiliar with installing electrical wiring.
4. Make sure the installation site you choose allows the fan blades to rotate without any obstructions. Allow a minimum clearance of 7 feet from the floor to the trailing edge of the blades.
5. If you are mounting the fan on a ceiling outlet box, use a metal outlet box. Secure the box directly to the building structure. The outlet box and its support must be able to support the moving weight of the fan (at least 50 lbs.). Do not use a plastic outlet box. Attach the mounting bracket by using the hardware supplied with the ceiling outlet box.
6. If you are mounting the fan to a joist, make sure it is strong enough to support the moving weight of the fan (at least 50 lbs.)
7. After installing the fan, make sure all the connections are secured. This will prevent the fan from falling.
8. Do not insert anything into the fan blades while the fan is operating.
9. Turn the fan off and wait for it to stop before reversing fan direction.
10. To reduce risk of electrical shock and personal injury, do not install the fan on a sloped ceiling.
11. To reduce the risk of electrical shock and personal injury, do not use this fan with any solid-state.
12. To reduce risk of personal injury, use only the two steel screws and lock washers provided with the fan for mounting the outlet box.

Table of Contents

ASSEMBLY DRAWING & PARTS LIST-WITH LIGHT.....	2
PRODUCT EXPLOSION DIAGRAM AND BILL OF MATERIALS.....	3
PRECAUTIONS BEFORE INSTALLING THIS PRODUCT.....	4
HOW TO INSTALL THE FAN-WITH LIGHT	5-10
REMOTE CONTROL SETTING AND OPERATING.....	11
IMPORTANT TIPS ABOUT REMOTE.....	12
PROTECTIVE FUNCTIONS OF THE RECEIVER.....	12
MAINTENANCE.....	13
BALANCING FAN/WOBBLING/TROUBLE SHOOTING.....	14

Product Instruction

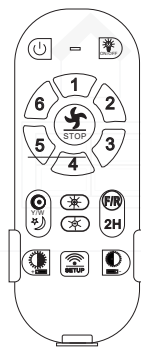
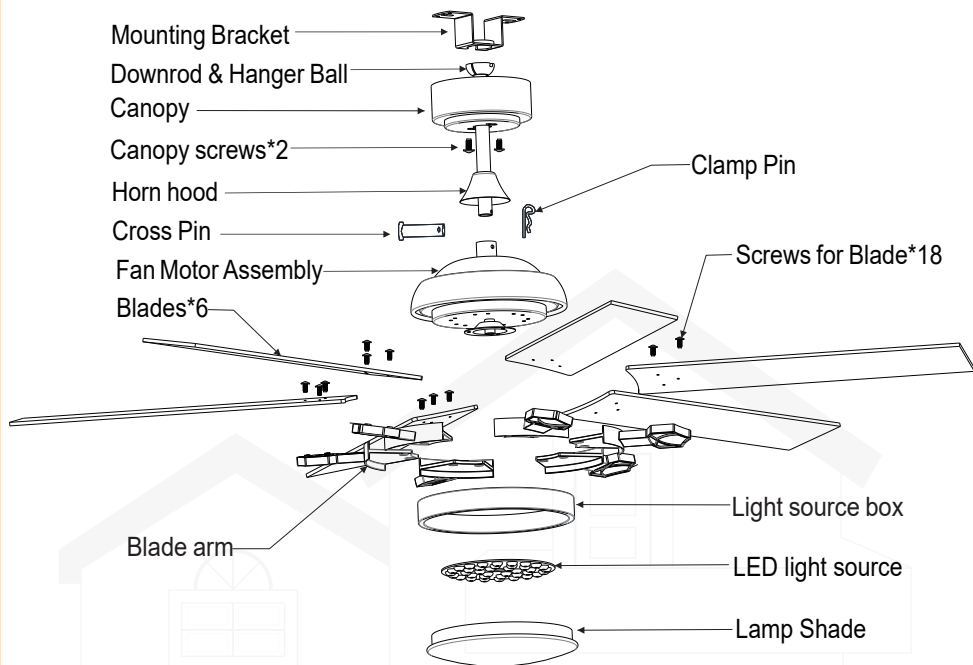



Remote Control

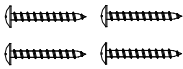
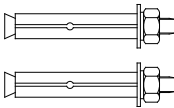

Receiver

SCREWS BAG

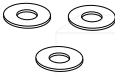
Item no.	Reference Image	Qty.
1	 <p>ST5x35 Setscrew</p>	x4
2	 <p>Expansion Screw</p>	x2
3	 <p>Screws for Blades</p>	x18
4	 <p>Fabric Washer</p>	x18

Dear Customer:

Thank you for choosing our product. To assist you in installing and using our product smoothly, we provide detailed installation videos. Here are the ways to access the installation videos:

1. View installation videos on the product page.
2. Contact us anytime to have the installation videos sent to you.

If you encounter any difficulties in finding or viewing the videos, or if you need additional support, please feel free to contact us. Our support team is dedicated to serving you and ensuring that you can install and use our product smoothly.

We wish you a smooth installation and enjoy using our product!

INSTALLING THE FAN

BEFORE YOU START

Contact a licensed electrician if you are not good at performing electrical work. It's the licensed electrician who installs the fan. If required by the local code. Do not use the fan with a dimmer switch. Turn off power at breaker.

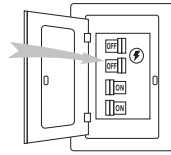

Tools and Materials Required



External Hexagonal Wrench



Wire Stripper



Phillips Screwdriver



Step Ladder

INSTALLING THE MOUNTING BRACKET

The ceiling fan must be installed in the location where there is 12"(300mm) spacing from the tips of all blades to the nearest objects or walls. REMEMBER to turn off the power before hanging the fan. Follow the instruction below to hang your fan properly:

1. For concrete ceiling, drill two holes in the ceiling and secure the mounting bracket to the ceiling with two $\Phi 0.32"$ (8mm) (distance between the two holes should be appropriate) expansion screws, flat washers nuts provided and tighten with a spanner.

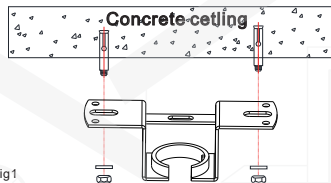

Fig1

2. For wood ceiling, secure the mounting bracket to the ceiling that is capable of carrying a load of at least 100lbs (45kgs) with two long mounting screws and washers provided. Be sure at least 0.12"(30mm) of the screw is threaded into the support.

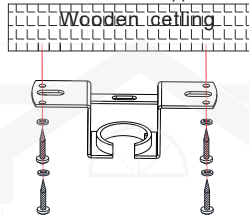
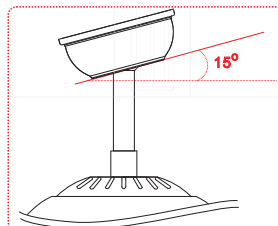

Fig2

3. Refer to the Fig. on the right to mount when the ceiling is angled (Max. 15°).

NOTE: The hanger must be able to withstand 100lbs (45kg) or more after the installation.



1: Fix the fan blades and forks with screws

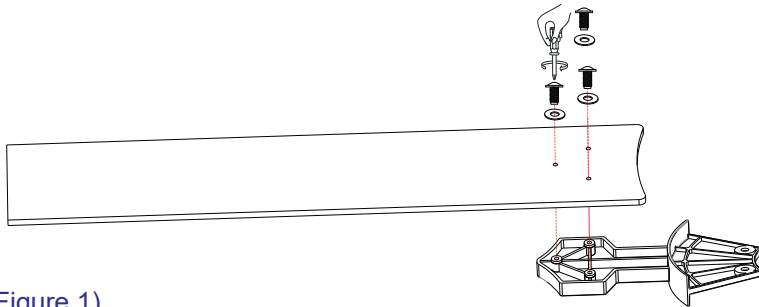

(Figure 1)

2: Assemble the blade assembly with the screws provided.

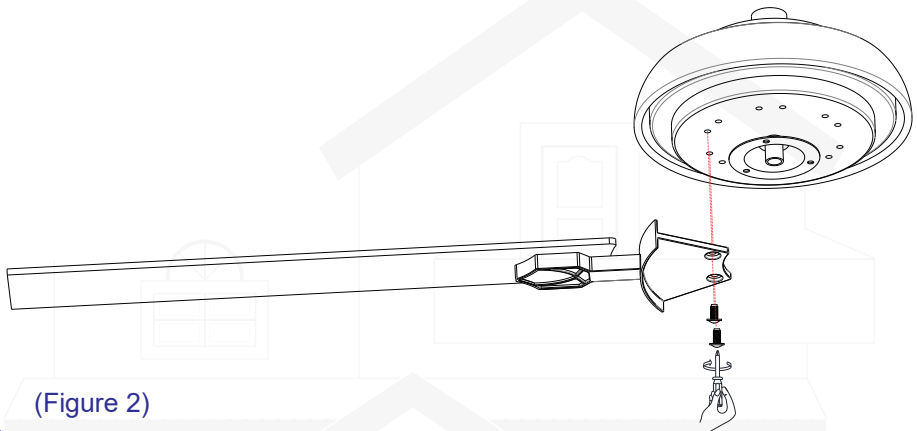

(Figure 2)

3; Loosen the set screws in the Hanger Ball assembly until the ball assembly can slide down the downrod. Remove the Pin from the downrod.

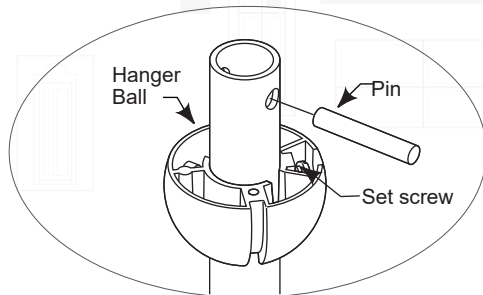

(Figure 3)

4; Remove and save the clevis pin and hairpin of the downrod. Put the downrod through the canopy and coupling cover.

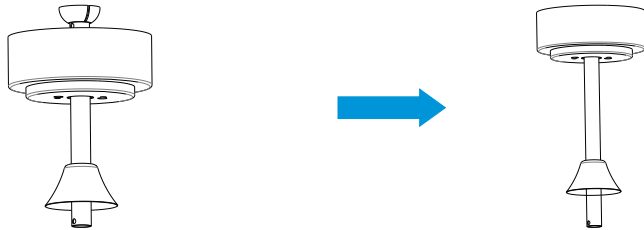

Figure 4

5; Loosen two set screws on the downrod support and then place the downrod into the downrod support. (Figure 5)

There add the electrical wires and the earth wire through the downrod.

Align the Clevis Pin holes in the Downrod with the holes in the Downrod Support. Be sure to push the straight leg of the Hairpin Clip through the hole near the end of the Clevis Pin until the curved portion of the Hairpin snaps around the Clevis Pin.

Finally, re-tighten the two set screws.

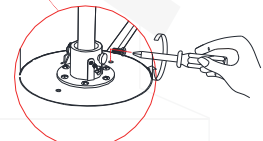
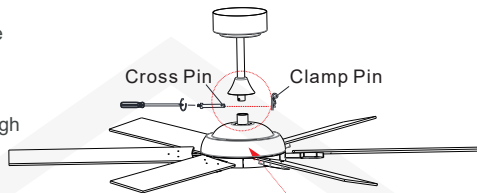

Figure 5

⚠ WARNING

It is critical that the clevis screw in the downrod support is properly installed and the set screws are securely tightened. Failure to verify the clevis screw, hairpin clip and set screws are properly installed could result in the fan falling.

6. Carefully lift the fan, and set the downrod / hanger ball assembly on the hanger bracket attached to the ceiling joist. Be sure the groove in the ball is properly aligned with the tab on the hanger bracket. (Figure 6)

⚠ WARNING

The fan must be hung with at least 230 cm of clearance from floor to blades.

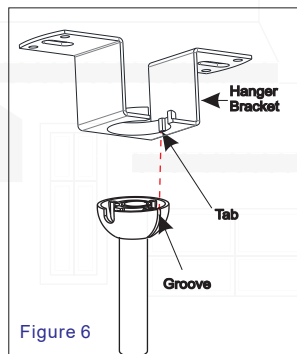

Figure 6

Precautions for connecting the power cord :

⚠ WARNING

To avoid possible electrical shock, be sure electricity is turned off at the main fuse box before wiring

Connect 110V main power (dwelling) to the Terminal Block located on the hanger

7; Correctly link the light wire, motor wire, and neutral wire and live wire according to the guidelines on the right

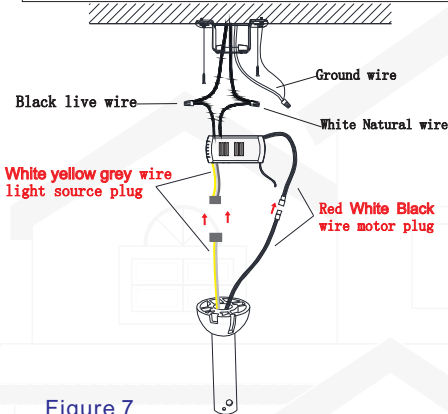
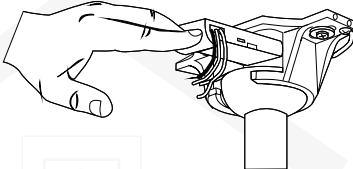
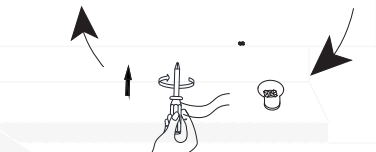
<p>① Connect the wires according to the polarity (the color of the House power cord may be different if the color is the same).</p>  <p>Figure 7</p>	<p>② Put the receiver into the Bracket and arrange the wires</p>  <p>③ Adjust the position of Canopy, then lock it</p> 
--	--

8. Installing light source box



Figure 8

9. Installing light source

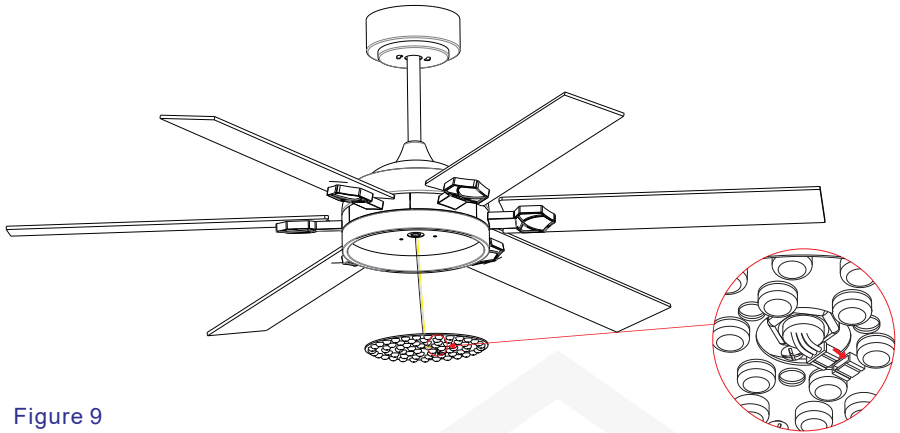

Figure 9

10. Installing Lamp shade

⚠ WARNING Take care not to over tighten when installing the glass shade

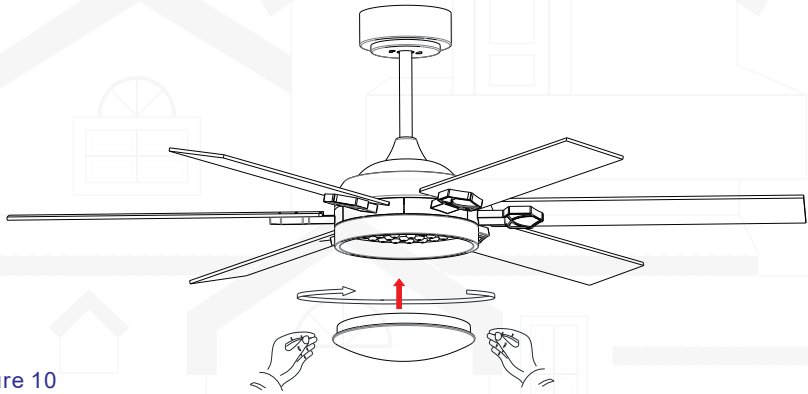
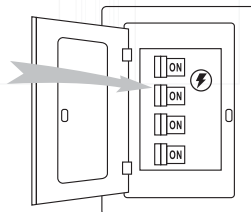

Figure 10

Installation is now finished . Turn on the power switch. Then the fan lights are on Test and pair your fan immediately using the remote control



REMOTE CONTROL SETTING AND OPERATION

1. Restore electrical to the outlet box by turning the electricity on at the main fuse box.
2. Remove the battery cover from the remote control transmitter, install the battery, and replace the cover.

Note:

- 1). Use AAA 2 1.5V battery to replace battery.
 - 2). If not using for long periods of time, remove the battery to prevent damage to the remote transmitter, and store the remote transmitter away from excess heat or humidity.
3. The buttons on the remote control transmitter control the fan speed and light as follows.

Remote Control (Esmmitter) Operation

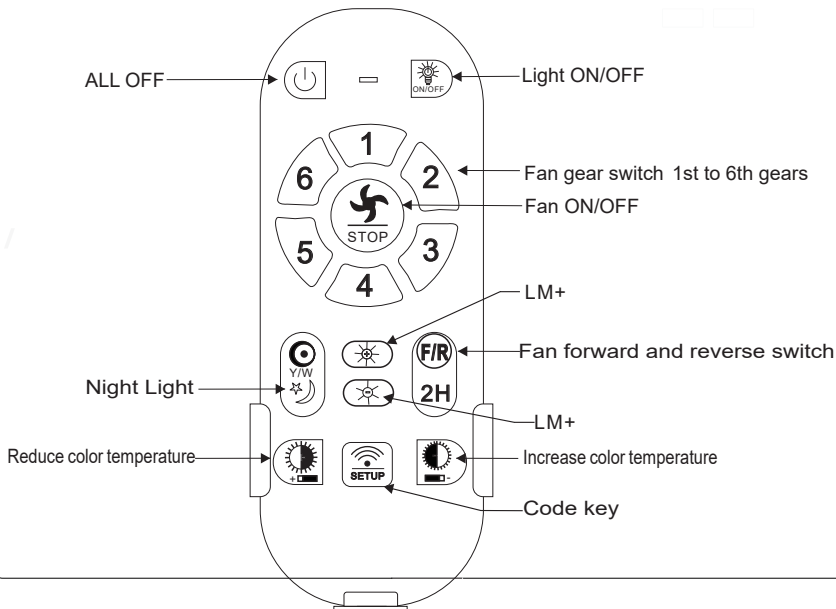
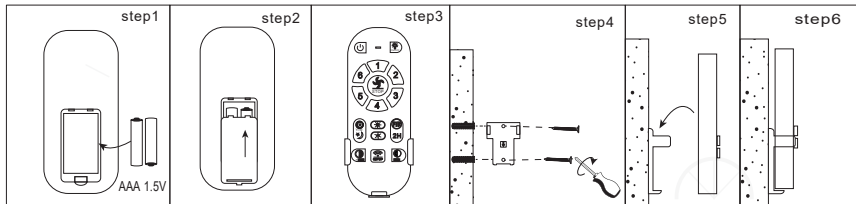

APP Instructions



Note

Note: If your APP interface is displayed in Chinese, click the menu in the upper left corner to switch languages.

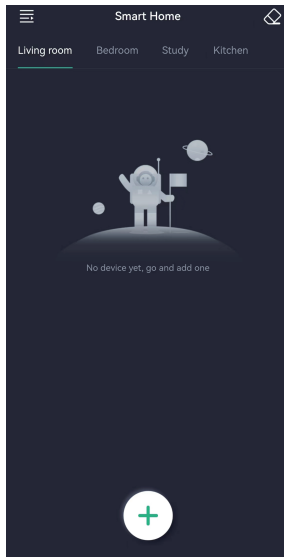

Step 01

Step 1: Click "+" button to set the name of your fan light.

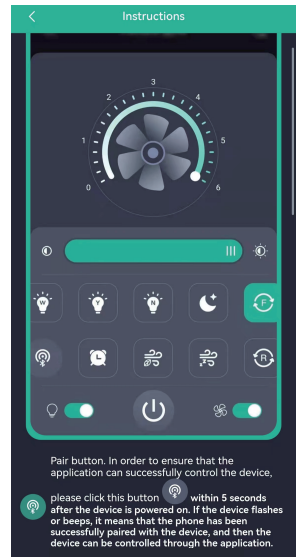

Step 02

Step 2: Click the pair button 1-2 times within 5 seconds after the fan is powered on. If the fan light flashes or beeps, it means the phone has been successfully paired.

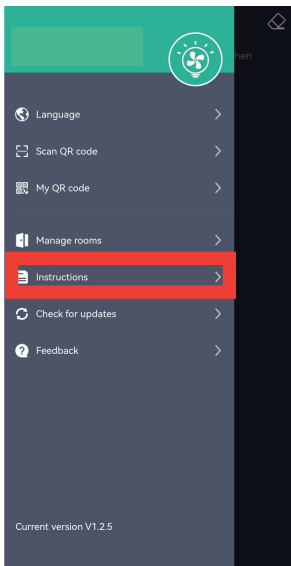

Instruction 01

Click the "Instructions" you can see the introduction of all the buttons.

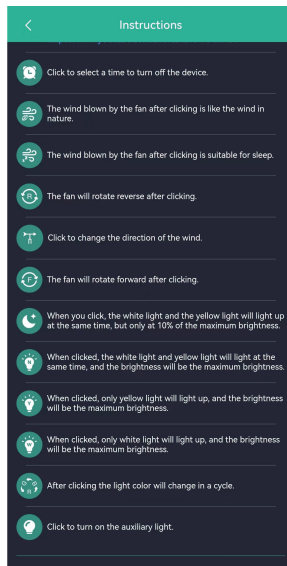

Instruction 02

11

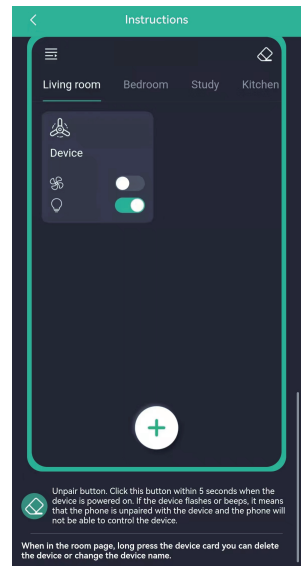

Instruction 03

1. Turn "ON" the power supply and within 30 seconds press and hold the transmitters "FAN ON/OFF" button for 5 seconds and a "beep" will be heard this will then activate a successful pairing and all functions will work normally.

IMPORTANT:

pairing initial step must be performed within 30 seconds of power being turned on.

1(a). when pairing multiple fans please ensure the isolation switch or power supply to the first installed fan is turned off prior to pairing further fans e.g please pair one fan at a time

1(b). please ensure isolation switch is kept to the ON position, the isolation switch is not to be used as a light switch as this will damage and make the remote receiver inoperable

2. If the transmitter functions are not working please check the battery orientation and power level. Low battery voltage will affect the functions of your transmitter and operation of your fan. Other remote controls nearby using the same frequency may cause interference with the Fans receiver.

3. Please remove batteries from the transmitter if leaving unused for an extended period of time.

4. Remote supports 200w maximum on lighting side.

IMPORTANT REMINDERS

1. Please note: Receiver must be correctly installed in the mounting bracket on fan

2. When the transmitter cannot control the receiver, please check the battery has sufficient charge in the transmitter.

3. When the transmitter cannot control the receiver, please check if there is any existence of similar remote controlled products nearby, causing interference with each other.

4. Low power of battery will affect the sensitivity of the transmitter and the signal reception accordingly, must replace if the battery is getting low power.

5. Please take the battery out from the transmitter when leaving unused for a long time, to avoid battery leaks.

6. Isolation Switch "Must be connected in the line."

7. When power is cut to the unit (via a blackout or otherwise) when power is restored the light will come on.

Before carrying out any cleaning or maintenance work, always make sure that the appliance is disconnected. LED lights are not removable. LED lights can only be used within the product delivery, they can not be replaced.



Lock protection- The DC motor has a built-in safety feature against blade or motor obstruction during operation. If something obstructs the fan blades or motor, the motor will keep trying to run and then stop operation after about 30 seconds of interruption. Please remove obstacles and reset. To reset: Turn the fan off by remote transmitter and then turn the fan on.

Over load protection (current limit)- The device will limit the maximum current output from the receiver/drive if the fan load has increased abnormally.

Tips

1. If your fan operates automatically after installation and power on, it is because your fan has memorized the previous factory setting. Use the Universal Mode or the learning function and your fan will be ready for use.
2. If the fan or light isn't working, reset power (turn the power off for at least 5 seconds and then turn the power back on) and redo the learn function setting.
3. It is not possible to remotely operate more than one fan in the same room (in the area where the remote signal can reach to) if they share the same power supply. Separate power supplies (such as using individual wall switches for each fan) is required if you want to separately control more than one fan in same room.
4. When the fan is turned on or operated using forward/reverse function, it shutters & goes back & forth until it turns.
This is a normal and it will take a few seconds to run this operation.

MAINTENANCE

1. Periodic cleaning of your new ceiling fan is the only maintenance that is needed.
2. When cleaning, use only a soft brush or lint free cloth to avoid scratching the finish.
3. Abrasive cleaning agents are not required and should be avoided to prevent damage to finish.

WARNING

Do not use solvents when cleaning your ceiling fan. It could damage the motor and create the possibility of electrical shock.

RECOMMENDED:

Periodically check that the blade sets to the fan motor setscrews are secure and tight.



Please note that all ceiling fans are not the same, even in the same model—some may move more or less than others.

Movement of a couple of centimeters is quite acceptable and does not suggest the fan will fall down.

Even though all blades are weighted and grouped by weight, it is impossible to eliminate wobble altogether. This should not be considered a fault. Ceiling fans tend to move during operation due to the fact that they are not generally rigidly mounted.

TRY THE FOLLOWING TO REDUCE A WOBBLING FAN;

1. Check that all of the blade mounting screws are tightened and secure.
2. Wobbling problems may result from inconsistent blade level. To check the blade level, measure the distance from each blade tip to the ceiling. Note: If measurements are inconsistent:
 - Be sure the blade mount screws are not too tight or too loose, which may cause wobbling due to an unlevel blade tip
 - An out of shape blade can cause wobbling. Check by removing the blade and placing on a flat surface.
3. Blade tracking may be checked simply by use of a household ruler. Place the ruler vertically against the ceiling and even with the outside leading edge of a blade. Note the distance of the edge of a blade compared to the others. Turn the blade slowly by hand to check the remaining blades.
If a blade is not in alignment, the blade is either out of shape, warped or the blade screws are not evenly tighten or either loose.

BALANCING KIT

A Balancing Kit has been provided to assist with reducing a wobble. Please retain the kit as it may become useful should the fan develop a wobble in the future.

- Step 1.** Clamp the balance clip to the middle position marked A of any fan blade. Turn on the fan and check if the vibration of the fan blades is reduced. Proceed to step 3 if the shaking is reduced. If shaking increases go to step 2.
- Step 2.** Take out the balance clip, clip it to the middle mark B of the clockwise adjacent blades, and so on until you find the fan blade that can reduce the shaking.
- Step 3.** When we found the fan blade that can reduce the shaking. Move the balance clip on the fan blade towards the center or edge and turn on the fan to see if the wobble is reduced. If the balance clip cannot fully counteract the shaking of the fan blade at the center or edge position, you can add an additional balance clip near the center or edge position for adjustment.
- Step 4.** When the fan blade no longer shakes, use a balance patch to stick to the position where the clip on the back of the fan blade is clamped to replace the balance clip. (1 balance patch instead of 1 balance clip)
- Step 5.** The adjustment is complete.

CEILING



MADE IN CHINA