

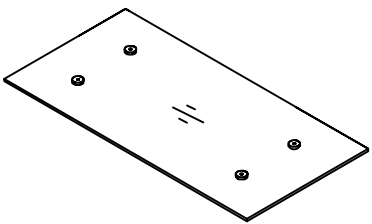

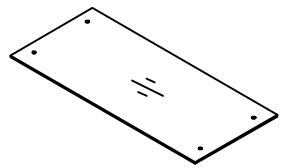

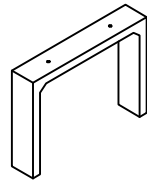



Note:

1. When receiving the goods, please confirm the product according to the listing of instruction. Once you find Less pieces, please provide relevant pictures to contact US. We will deal it in the time.
2. Please install goods with the instruction manua.
3. It is recommended that the installation should not be too tight to adjust easily. After the structu is installed, firm the interface for more stability.

ASSEMBLING INSTRUCTION

									
A x1pc	B x1pc	C x2pcs	D x8pcs	E x4pcs M8*285	F x12pcs	G x4pcs M8	H x4pcs Ø18	I x4pcs Ø20	J x1pc M8

step1.

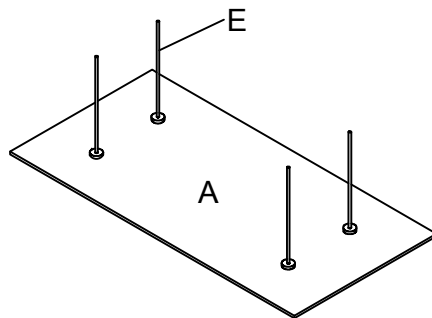

step2.

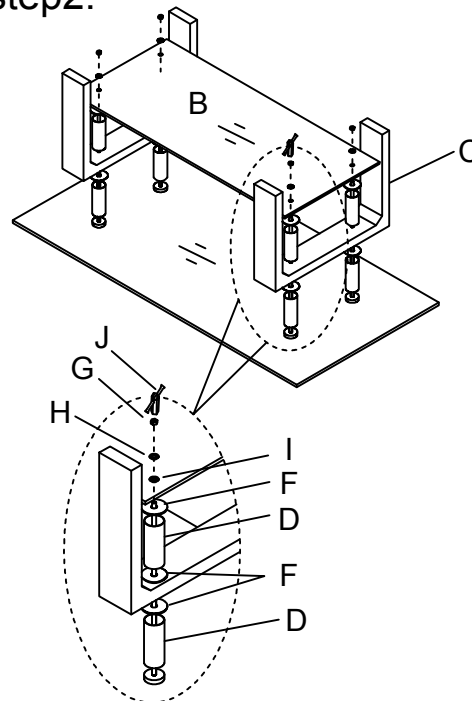

step3.

