

CARE AND MAINTENANCE

Store outdoor furniture indoors or cover well when not in use.
Remove wicker furniture from standing water. Dust regularly with small brush or vacuum
Spills should be taken care of immediately before they harden or stain with a slightly dampened sponge.











NOTICE

- * Please make sure that you have all parts indicated before you begin assembly of this item
- * This item should be assembled on a soft surface to prevent scratching the finish during assembly
- * This item may require periodic tightening

**Weight Capacity : 275 Lbs (chair)
550 Lbs (bench)**

**Warning : Do not stand on corner
Warning : Do not over torque bolts/screws**

Part List and Hardware List

PIECE	DESCRIPTION	PICTURE	QUANTITY
B	Chair Leg - 1		2X
G	Corner Seat Frame		1X
H	Corner Right Seat Frame		1X
I	Corner Left Seat Frame		1X
J	Corner Seat Cushion		3X
K	Corner Back Long Cushion		3X
L	Corner Back Short Cushion		1X
M	Chair Leg - 2		1X
HW1	Socket Screws 6x0.5x15mm		18X
HW2	Allen key		3X



Product Dimensions:
23.62"x26.38"x29.13" H (Chair)
39.37"x25.59"x14.96" H (Table)
26.38"x26.38"x29.13" H (Corner)

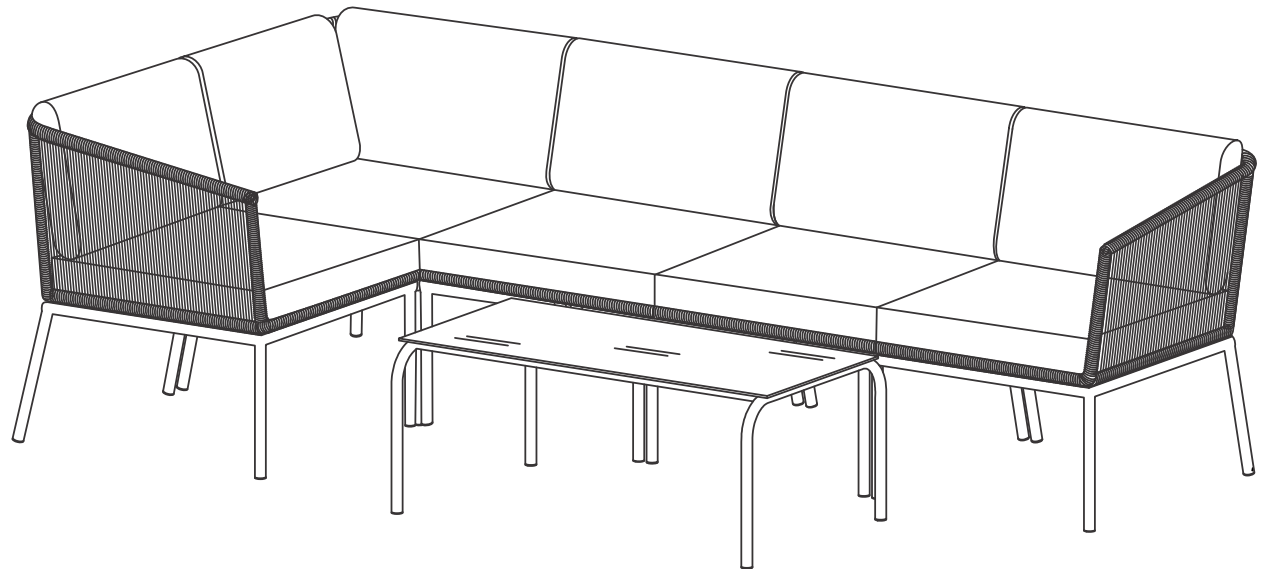

CARE AND MAINTENANCE

Store outdoor furniture indoors or cover well when not in use.
Remove wicker furniture from standing water. Dust regularly with small brush or vacuum
Spills should be taken care of immediately before they harden or stain with a slightly dampened sponge.





NOTICE

- * Please make sure that you have all parts indicated before you begin assembly of this item
- * This item should be assembled on a soft surface to prevent scratching the finish during assembly
- * This item may require periodic tightening

**Weight Capacity : 275 Lbs (chair)
550 Lbs (bench)**

**Warning : Do not stand on corner
Warning : Do not over torque bolts/screws**

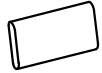
Part List and Hardware List

PIECE	DESCRIPTION	PICTURE	QUANTITY
B	Chair Leg - 1		1X
H	Corner Right Seat Frame		1X
J	Corner Seat Cushion		1X
K	Corner Back Long Cushion		1X
HW1	Socket Screws 6x0.5x15mm		6X
HW2	Allen key		1X

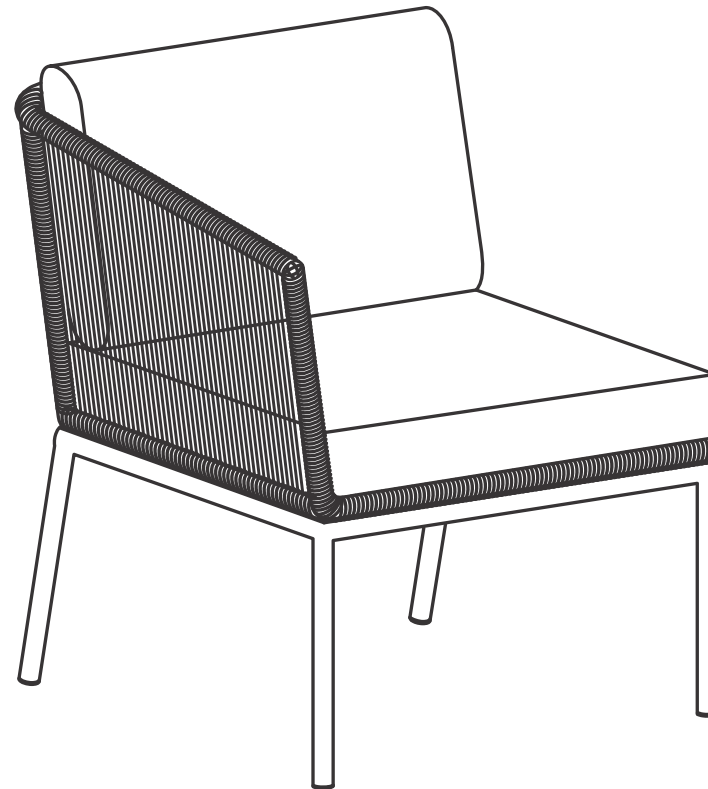

PREPARATION

Before beginning assembly of product, make sure all parts are present. Compare parts with package contents list and hardware contents list.

If any part is missing or damaged, do not attempt to assemble the product.

Estimated Assembly Time: 15 minutes.

Tools Required for Assembly (included): Allen Key

1

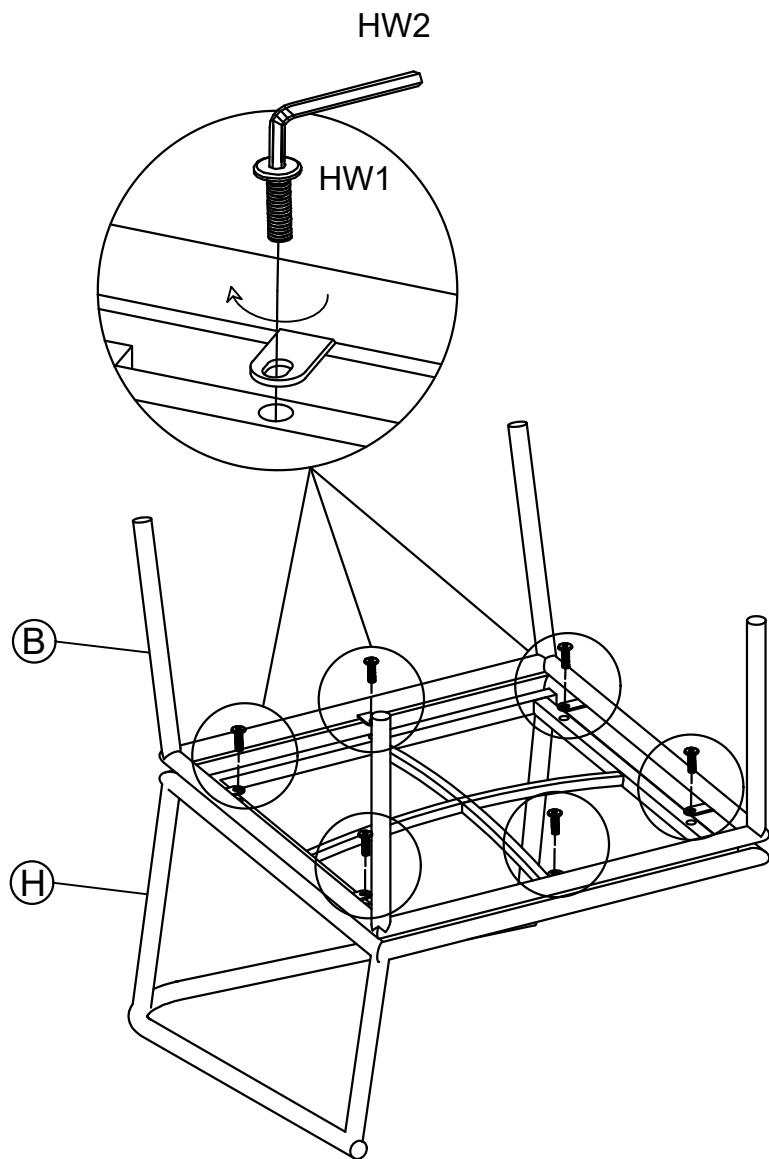

2

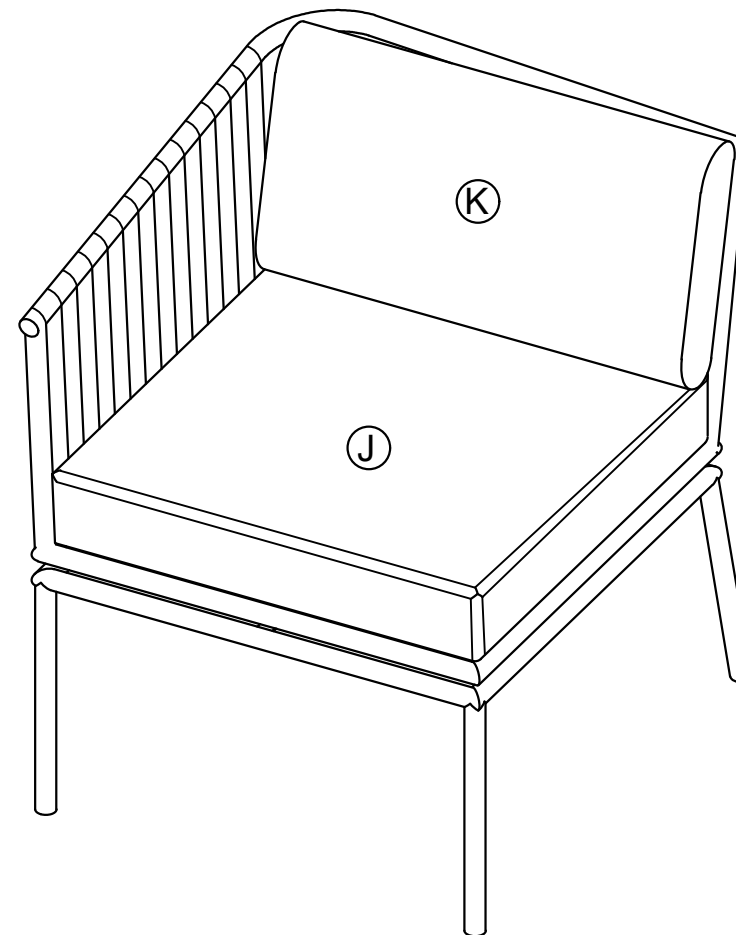

Step 1

Attach Chair Leg - 1 (B) to Corner Right Seat Frame (H). Use Bolt (HW1) tighten with Allen Key (HW2)

Step 2

Put on Corner Seat Cushion (J) & Corner Back Long Cushion (K) to complete Corner