

# Installation Instructions

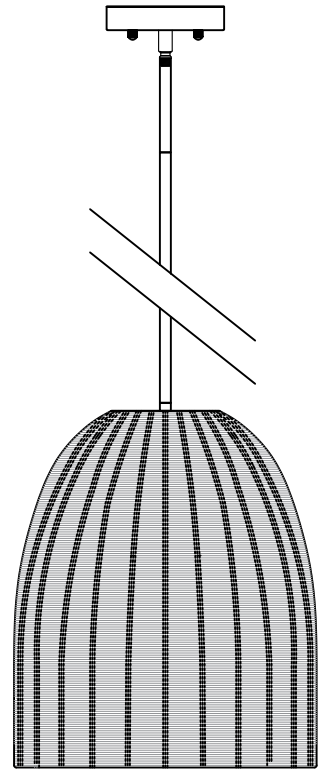

1 x Max 15W Medium Base

## Safety Information

### READ AND SAVE THESE INSTRUCTIONS

1. For your protection and safety, carefully read and understand the information provided in this manual completely before attempting to assemble, install, or operate this product. Failure to do so could lead to electrical shock, fire, or other injuries that could be hazardous or even fatal.
2. Before touching any wire, use a voltage tester to make sure it not live.
3. When replacing fuses, turn off the main power first. Make sure your hands and feet are dry, and place one hand behind your back to prevent electricity from making a complete circuit through your chest. Touch the plug fuse only by its insulated rim. Remove cartridge fuses with a fuse puller.
4. Use tools with insulated handles and ladders made of wood or fiberglass.
5. To protect children, place a safety cover over any unused outlets.



**DANGER:** Before starting installation of this fixture or removal of a previous fixture, disconnect the power by turning off the circuit breaker, removing the fuse at the fuse box, or tripping the breaker that controls that circuit. Tape a sign to the panel warning others to leave the circuit alone while you work.



**CAUTION:** CONSULT A QUALIFIED ELECTRICIAN IF YOU HAVE ANY ELECTRICAL QUESTIONS. If you have any non-electrical questions about this fixture please contact our customer service via the distributor where you purchased this product from. We will be more than happy to assist.

# Pre-Installation

## PLANNING INSTALLATION

Read all instructions before installing.

To avoid damaging this product, place it on a soft, non-abrasive surface, such as carpet or cardboard.

## TOOLS REQUIRED (NOT INCLUDED)

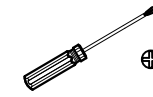

Phillips  
Screwdriver



Wire  
Stripper



Pliers



Safety  
Goggles



Electrical  
Tape

## Warranty

### ONE (1) YEAR WARRANTY

#### WHAT IS COVERED

The manufacturer warrants this fixture to be free from defects in materials and workmanship for a period of one (1) year from date of purchase.

The warranty applies only to the original consumer purchaser and only to products used in normal use and service.

If this product is found to be defective, the manufacturer's only obligation, and your exclusive remedy, is the repair or replacement of the product at the manufacturer's discretion, provided that the product has not been damaged through misuse, abuse, accident, modifications, alteration, way not in accordance with the instructions supplied with the product. This warranty shall not apply to a failure of the product as a result of an accident, misuse, abuse, negligence, alteration, faulty installation, or any other failure not relating to faulty material or workmanship.

This warranty shall not apply to the finish on any portion of the product, such as surface and/or weathering, as this is considered normal wear and tear.





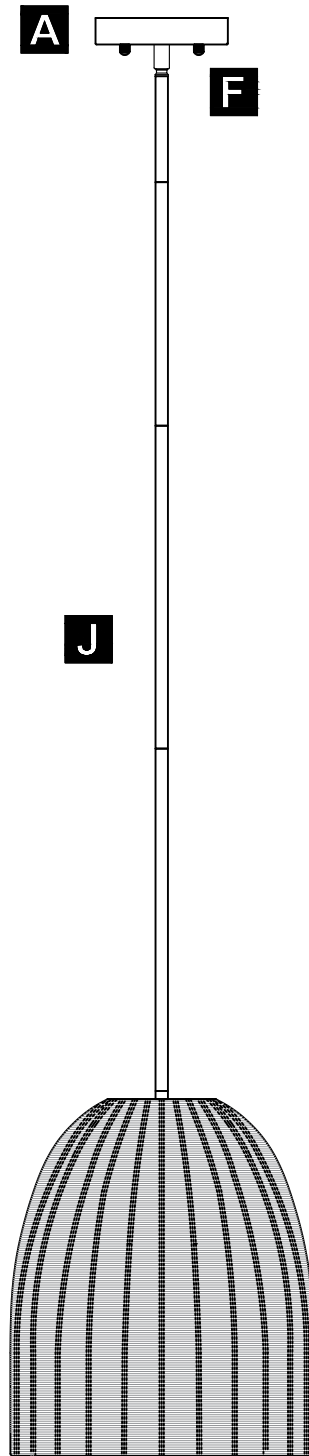

#### WHAT IS NOT COVERED

The manufacturer does not warrant and specifically disclaims any warranty, whether expressed or implied, of fitness for a particular purpose, other than the warranty contained herein. The manufacturer specifically disclaims any liability and shall not be liable for any consequential or incidental loss or damage, including but not limited to any labor/expense costs involved in the replacement or repair of said product.

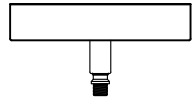
# ASSEMBLY GUIDE

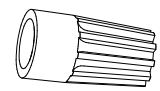

## HARDWARE INCLUDED

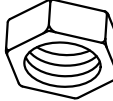
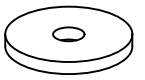
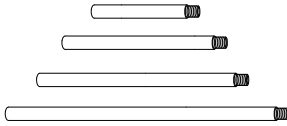
<b>A</b>  Canopy	<b>B</b>  Mounting plate	<b>C</b>  Outlet box screw (short) x 2
<b>D</b>  Green ground screw (On mounting plate)	<b>E</b>  Wire connector x 3	<b>F</b>  Finial x 2
<b>G</b>  Support screw (long) x 2	<b>H</b>  Hexn nut x 4	<b>I</b>  Flat washer x 2
Package 1		
<b>J</b>  Downrods x 4		
Package 2		

## Assembly Instructions

Assembly of this fixture will be accomplished by first determining the length of stem or chain required, attaching the mounting plate to the junction box, making all necessary electrical connections, hanging the fixture from the ceiling and then installing the fixture.

## Safety Warning

Read wiring and grounding instruction and any additional directions. Turn power supply off during installation. If new wiring is required, consult a qualified electrician or local authorities for code requirements.

STEP 1

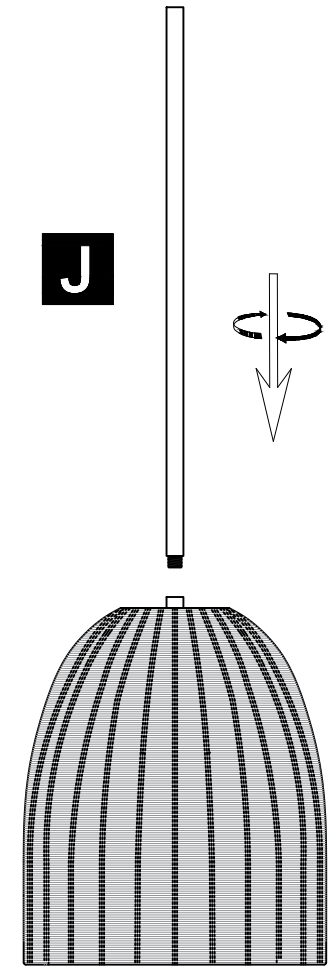

STEP 2

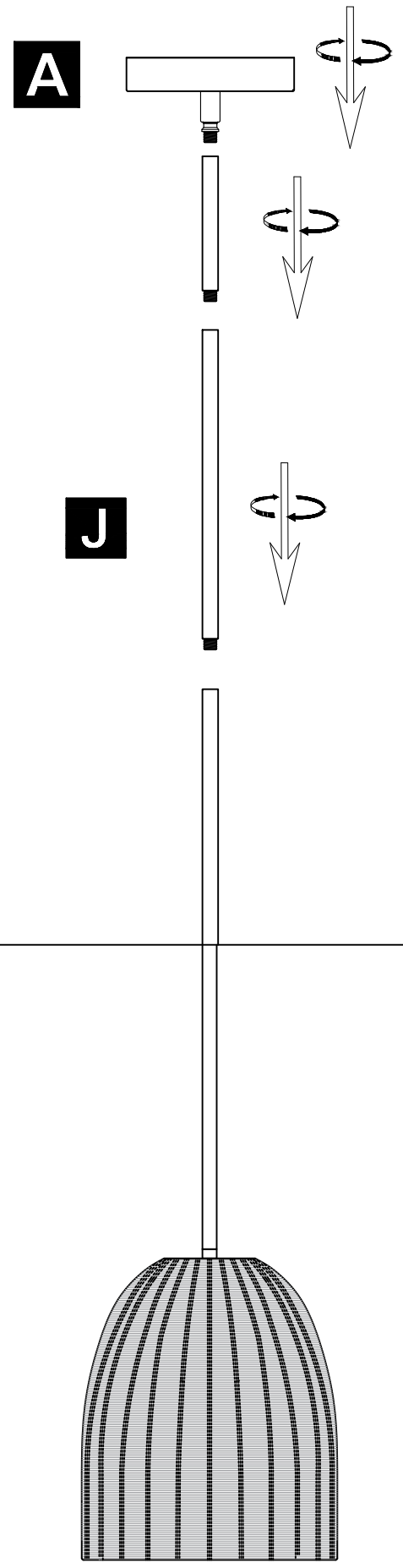

STEP 3

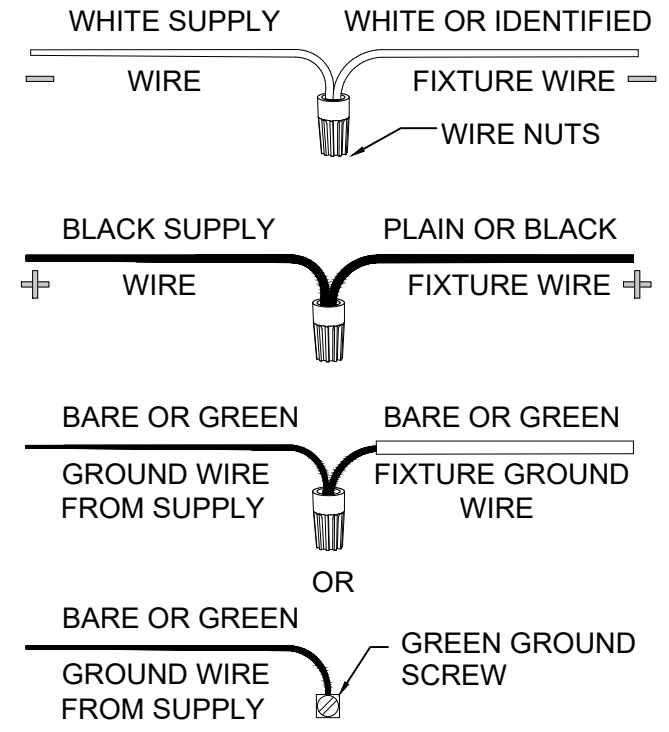
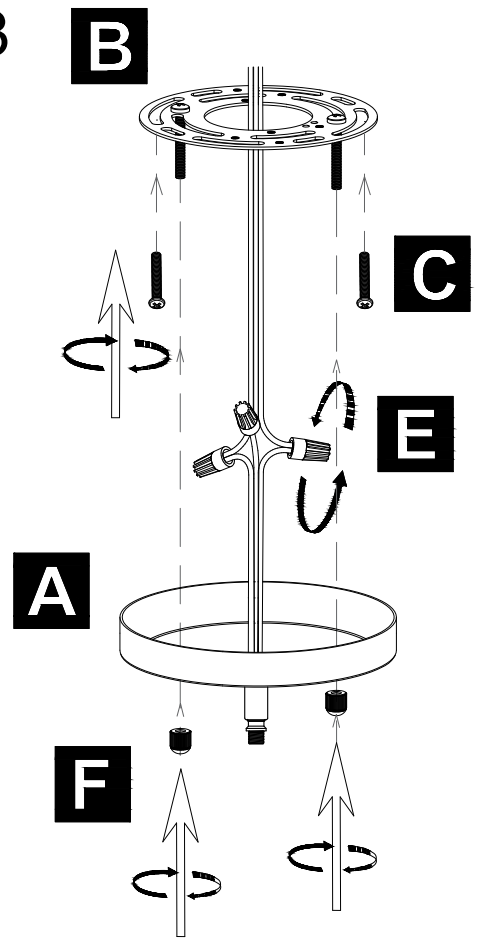

STEP 4

