

Wicker Folding Hanging Chair

Assembly & Care instructions

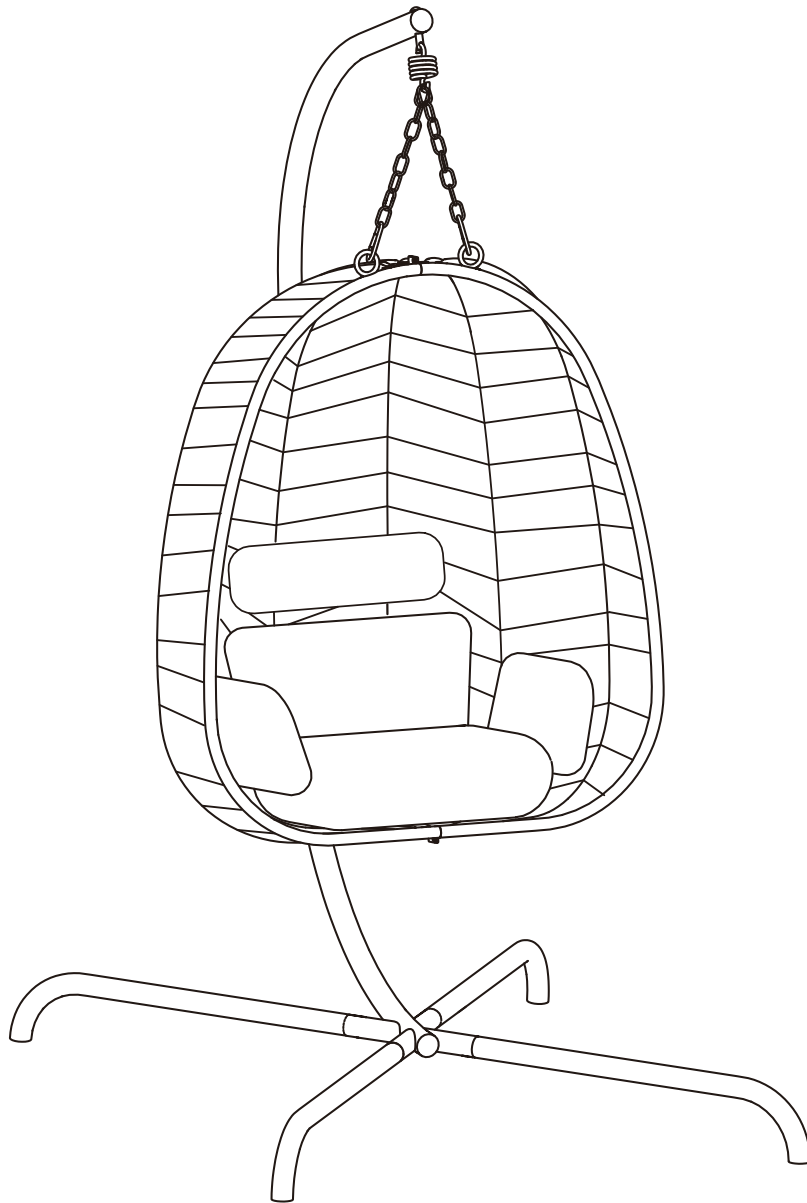

SKU:P25076-D1

Please read & retain for future reference

Catalog

Care & Instructions 3

Part List 4

Screw Set 5

Extra 6

Specifications 7

Installation steps 8

Thank you for ordering the Wicker Folding Hanging Chair, here are some tips which may help you:

1. The cushions are vacuum packed, after you open the package, they will fully return to the original thickness after a while.

2. If any part is damaged or missing (please refer to packing list on page 4~6), please feel free to contact us. We will send you the replacement immediately.

3. In order to prolong the hanging chair service life, we suggest that you put all the cushions indoors on a rainy day.

4. We hope you can enjoy our product, if you have any other problem, please feel free to contact us.

5. To prevent scratches, assemble this furniture on a soft surface, such as a rug.

Contact US:
Service@alaulm.com
www.alaulm.com

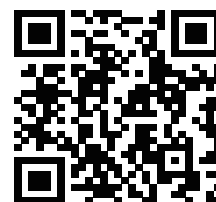



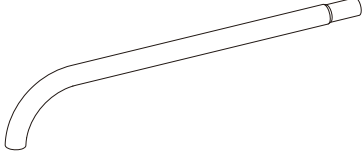
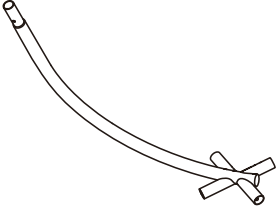
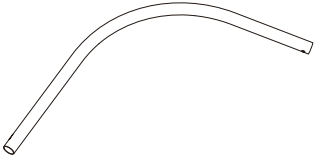
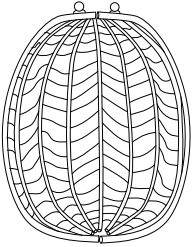
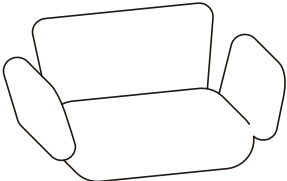
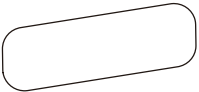





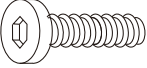

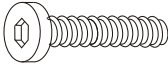
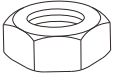
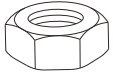
PARTS LIST

Parts List			
Part	Icon	Description	Qty
L001		Leg Bar	4PC
L002		Base Support Bar	1PC
L003		Suspension Rod	1PC
L004		Hanging Basket	1PC
L005		Seat Cushion with Core	1PC
L006		Pillow with Core	1PC

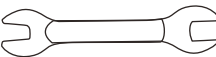
SCREW SET

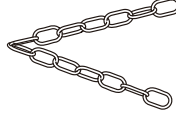
Screw Set

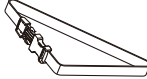
Part	Icon	Description	Qty
A		M6x25	2PCS
B		M8x17	5PCS
C		M8x57	1PC
D		M6 Nut	2PCS
E		M8 Nut	1PC
F		M6 Gasket	4PCS
G		M8 Gasket	7PCS
H		Allen Wrench	1PC
I		Wrench	1PC
J		Double Hook Spring	1PC
K		Chain	1PC
L		Hook	2PCS
M		Round Cap Bar	1PC
N		Safety Belt	1PC

Extra

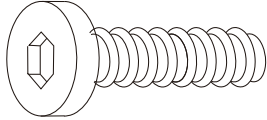
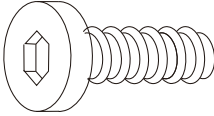
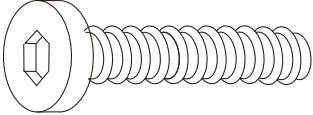
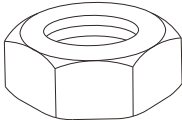
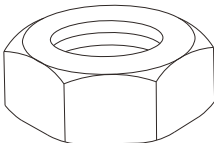
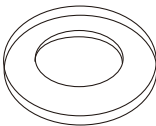
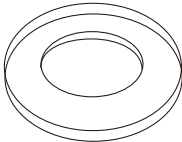
Part	Icon	Description	Qty
A		M6x25	1PC
B		M8x17	1PC
C		M8x57	1PC
D		M6 Nut	1PC
E		M8 Nut	1PC
F		M6 Gasket	1PC
G		M8 Gasket	1PC

WARNING: Failure to locate parts in accordance with these diagrams, or failure to use special parts provided with this equipment, may result in property damage or personal injury.

SPECIFICATIONS

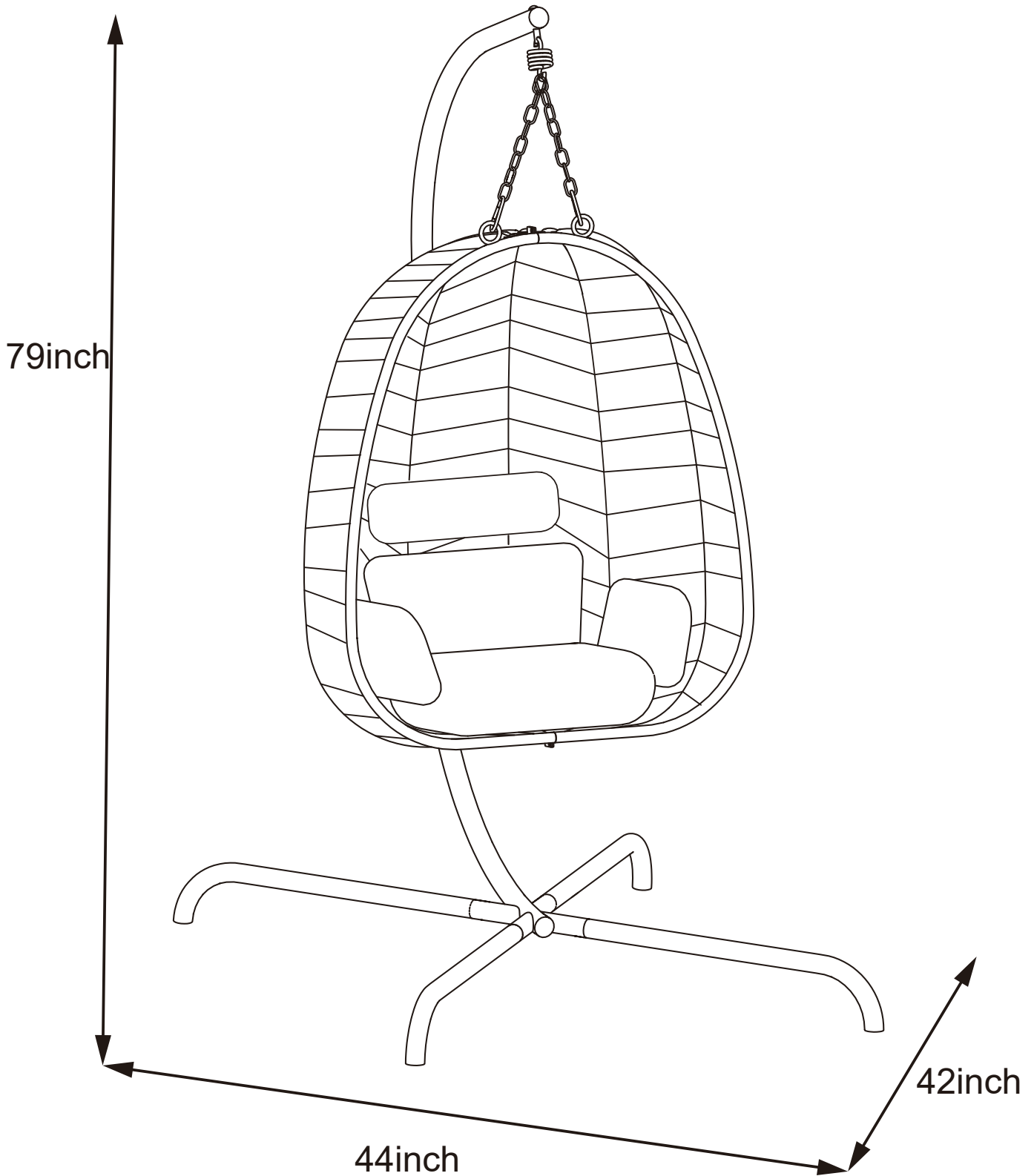

Installation steps

Step 1

Connect Leg Bars(L001) and Base Support Bar(L002) with screws(B) and tighten securely.

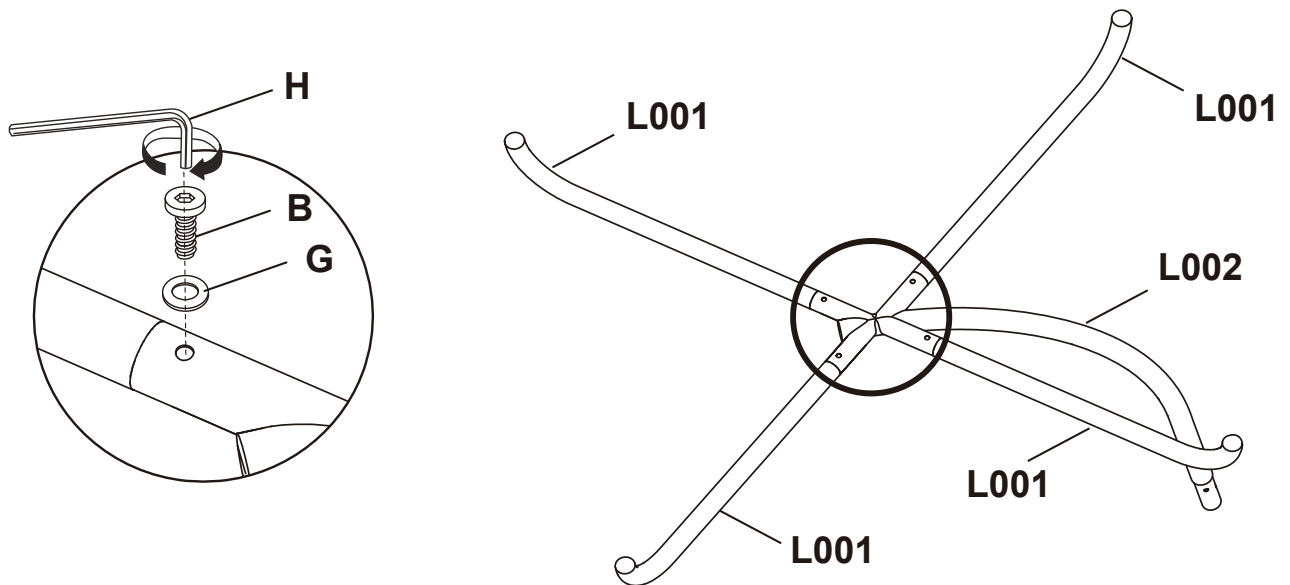

L001 x4



L002 x1



B x4

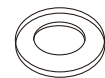

G x4

Step 2

Fit Suspension Rod(L003) onto Base Support Bar(L002) and tighten with screws(B & C).

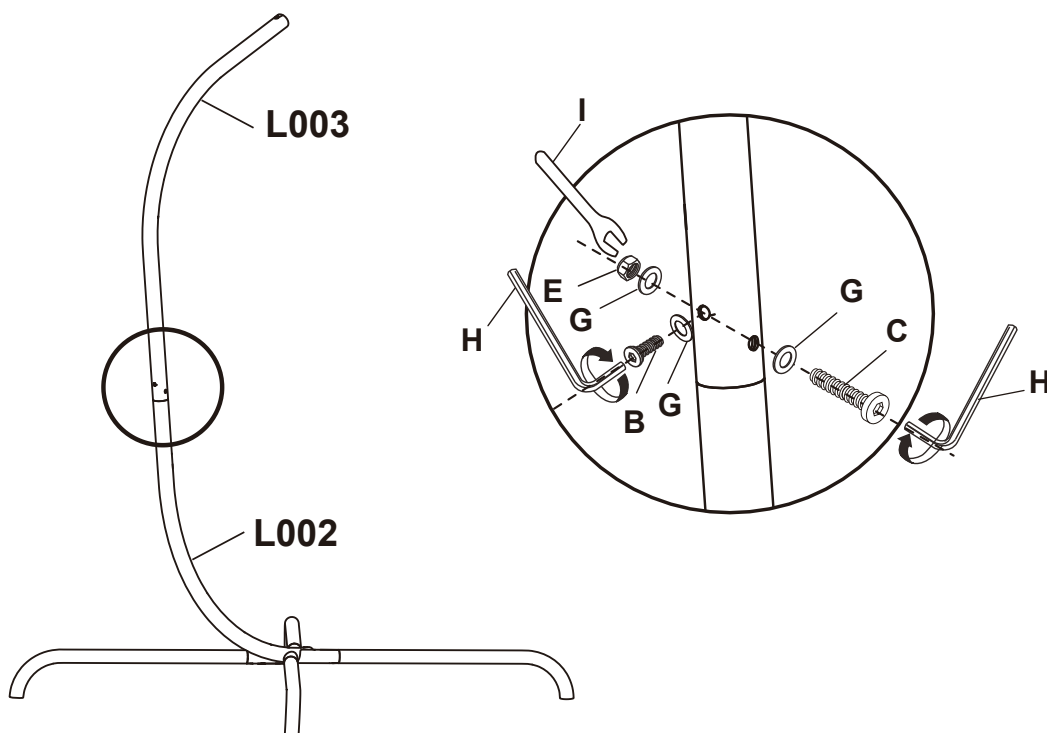

L003 x1



B x1

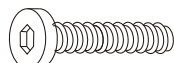

C x1



E x1



G x3

Installation steps

Step 3

Unfold the Hanging Basket(L004) and tighten the top and bottom metal fittings with screws(A) and nuts(D).
 This step is recommended to be performed by **two adults**: one fully opens the basket while the other assembles the screws.
 After fully opening the hammock, first assemble the bottom screws and tighten them to 50% torque. Then assemble the top screws and tighten them to 50% torque. Finally, tighten both sets of screws to 100% torque.

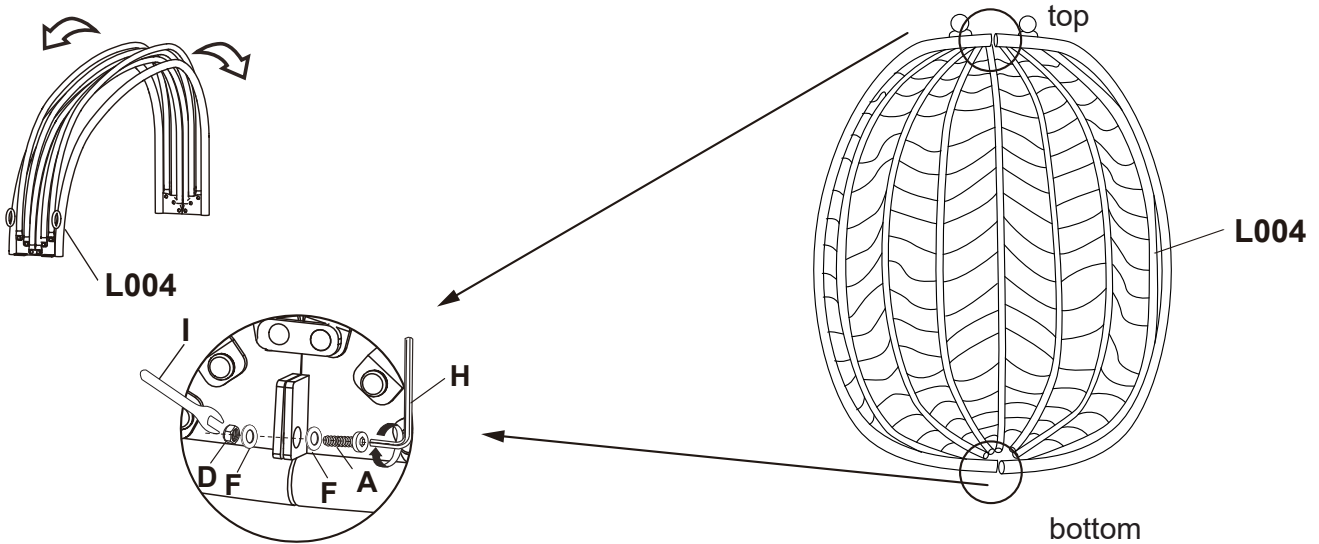

L004 x1

A x2

D x2

F x4

Step 4

Install the chain, hooks and round cap bar (J,K,L,M) on the suspension rod (L003).

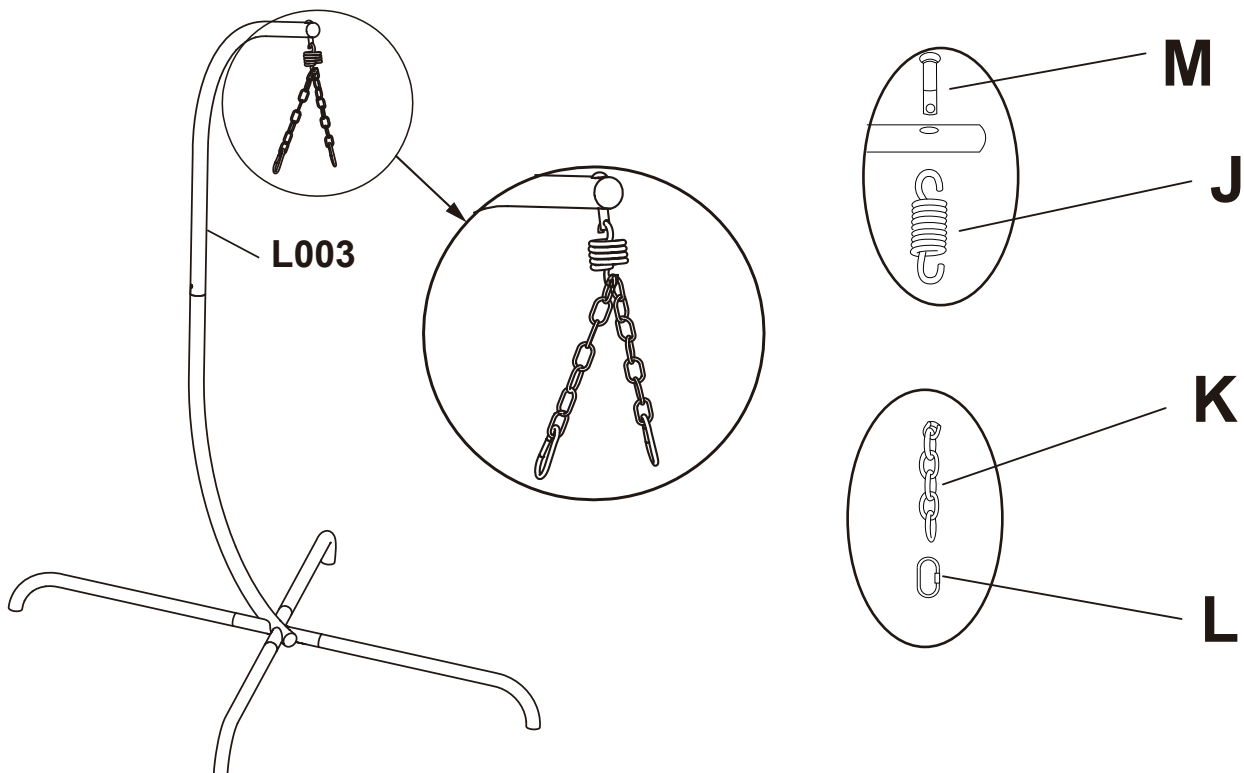

J x1



K x1

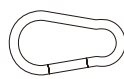

L x2

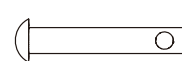

M x1

Installation steps

Step 5

Hang the hanging basket(K004) on the hooks(L) and place the cushion(L005) and pillow(L006) inside.

NOTE:Please adjust the sofa cushions to the right height.

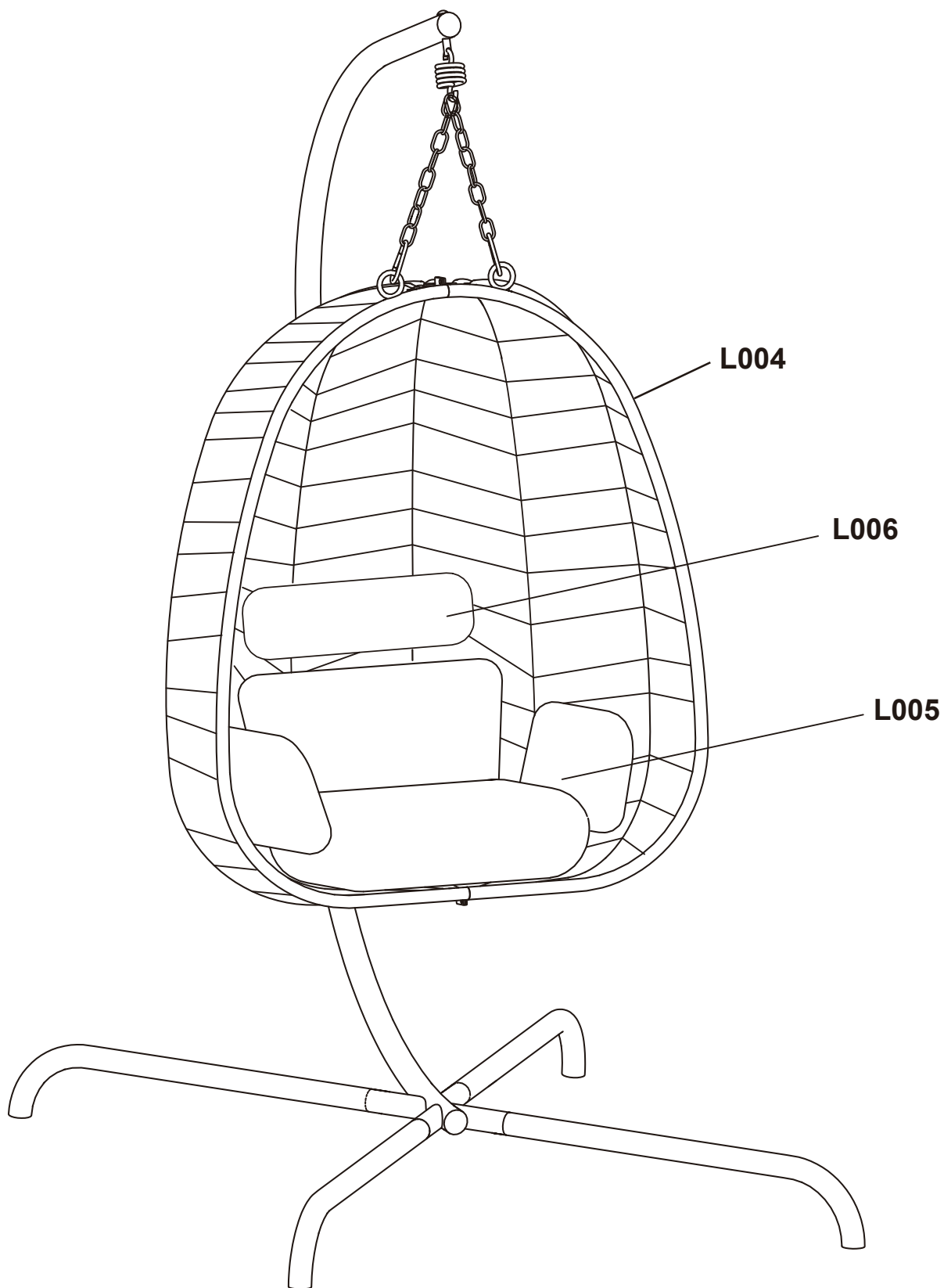

L005 x1



L006 x1

Installation steps

Step 6

Use the safety belt(N) to connect the hanging basket(L004) and suspension rod(L003).

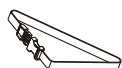
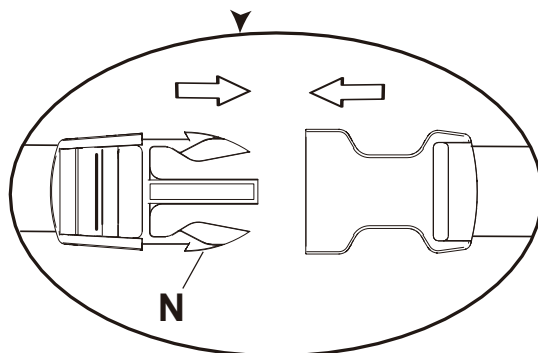
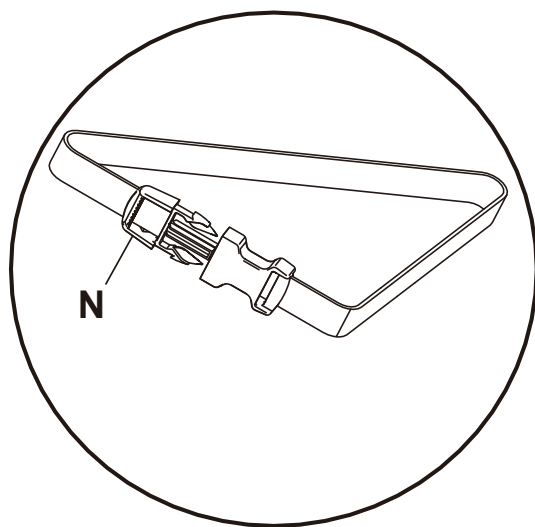
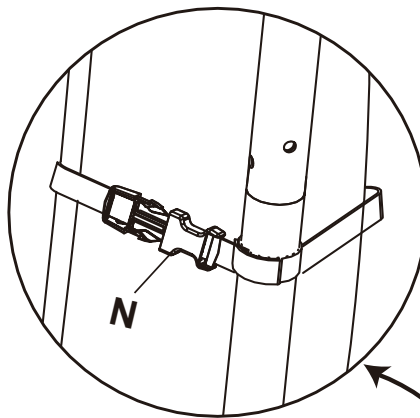
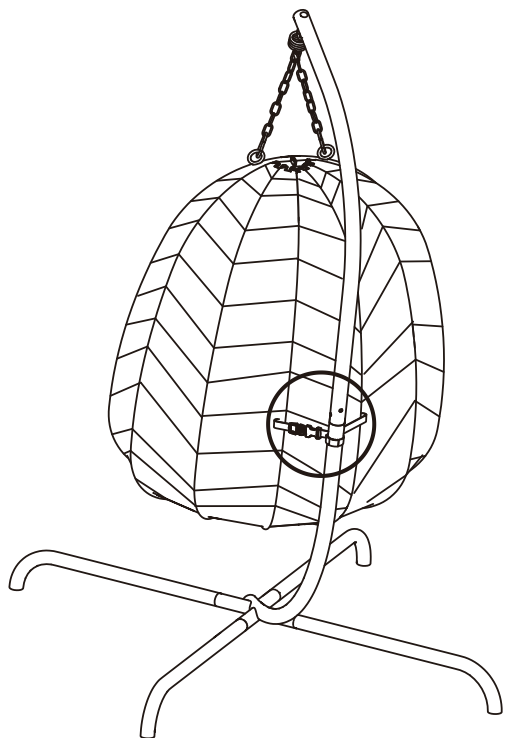

N x1

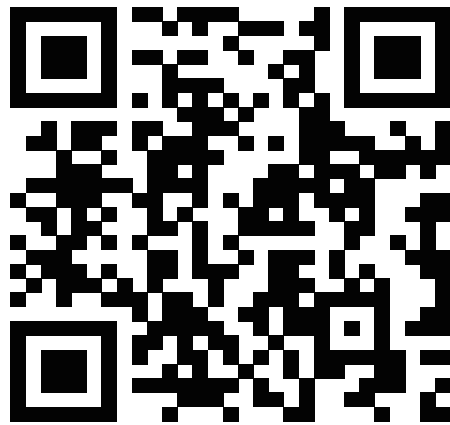

www.alaulm.com

Make your life much better.