

Installation Instructions

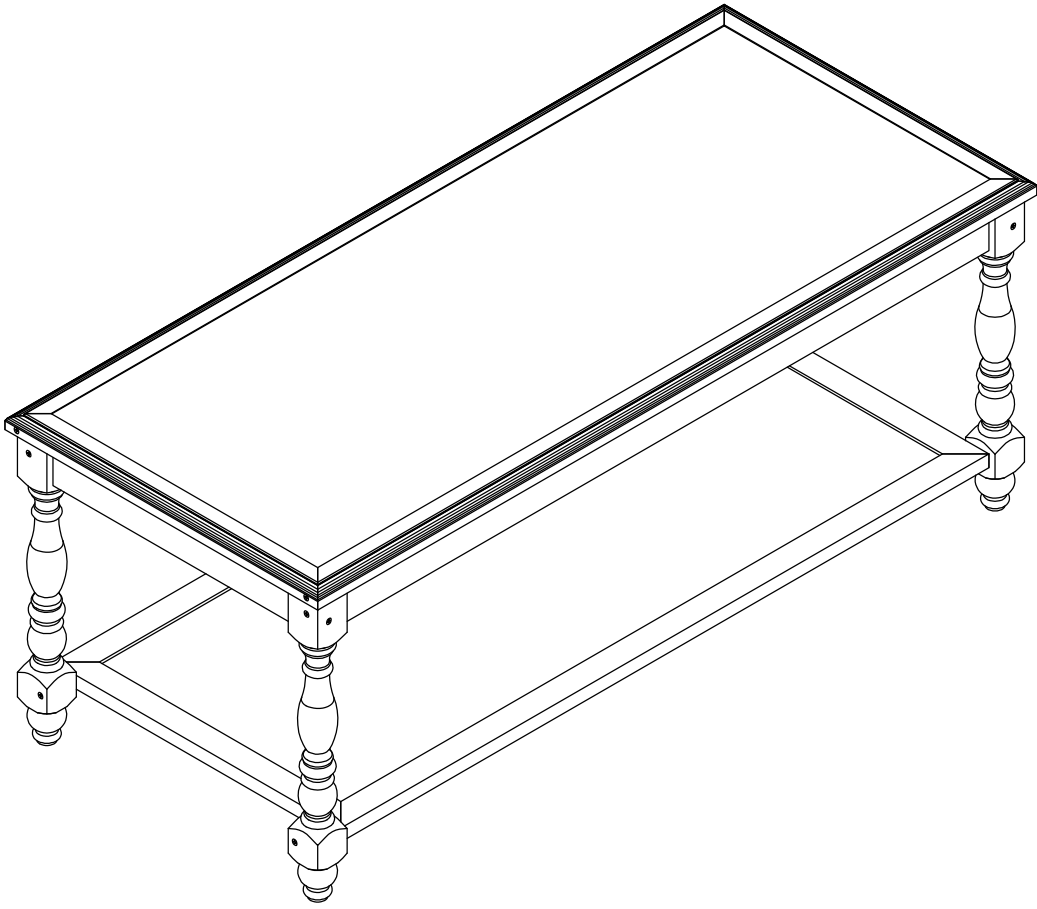

Board Identification

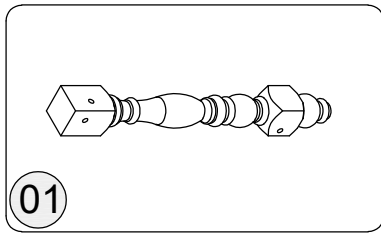

left foot
Qty:2

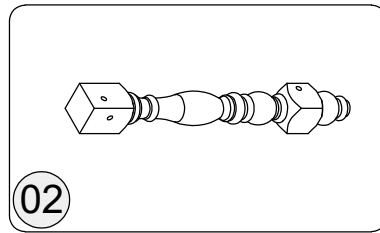

right foot
Qty:2

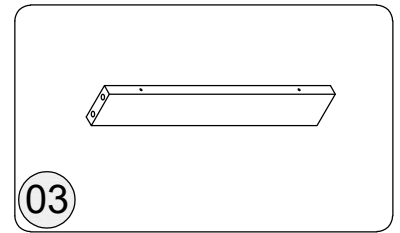

Short pull board
Qty:2

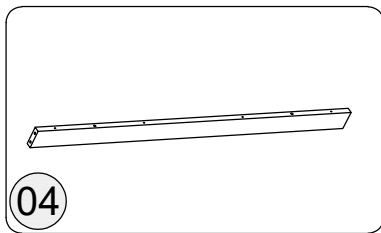

Long pull board
Qty:2

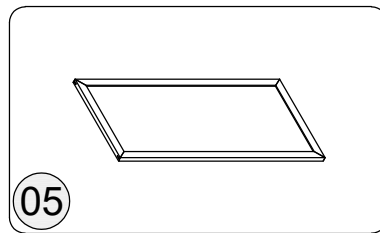

base
Qty:1

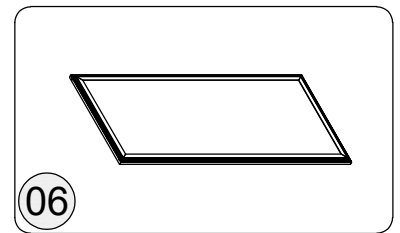

panel
Qty:1

Hardware Identification

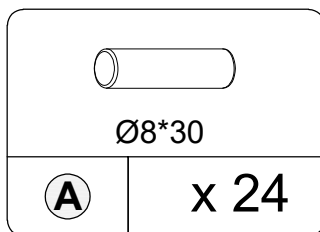

Wooden tenons

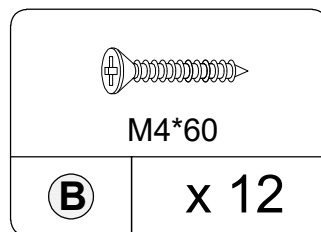

Screw

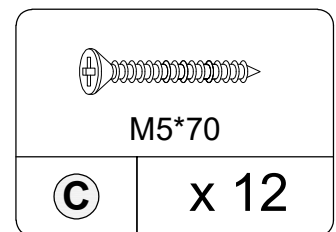

Screw

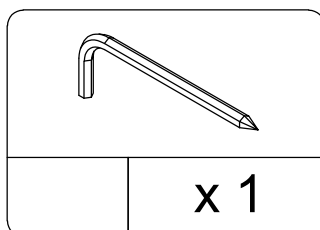

Hex key

Step 1

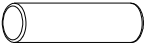
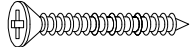
	
Ø8*30	
(A)	x 4
	
M5*70	
(C)	x 2

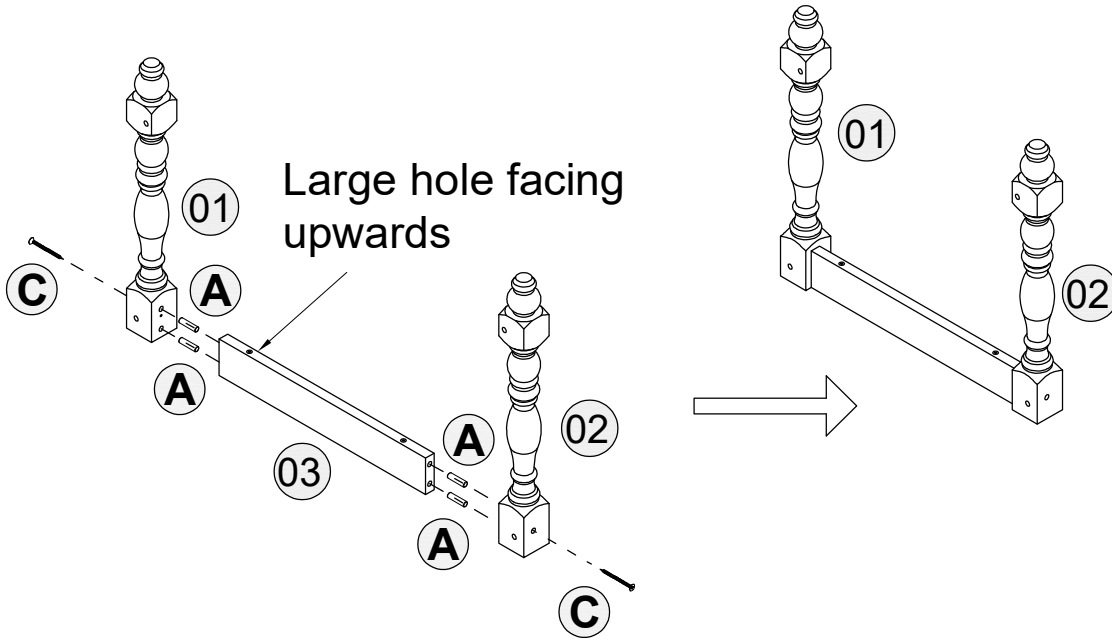

Step 2

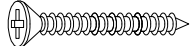
	
Ø8*30	
(A)	x 4
	
M5*70	
(C)	x 2

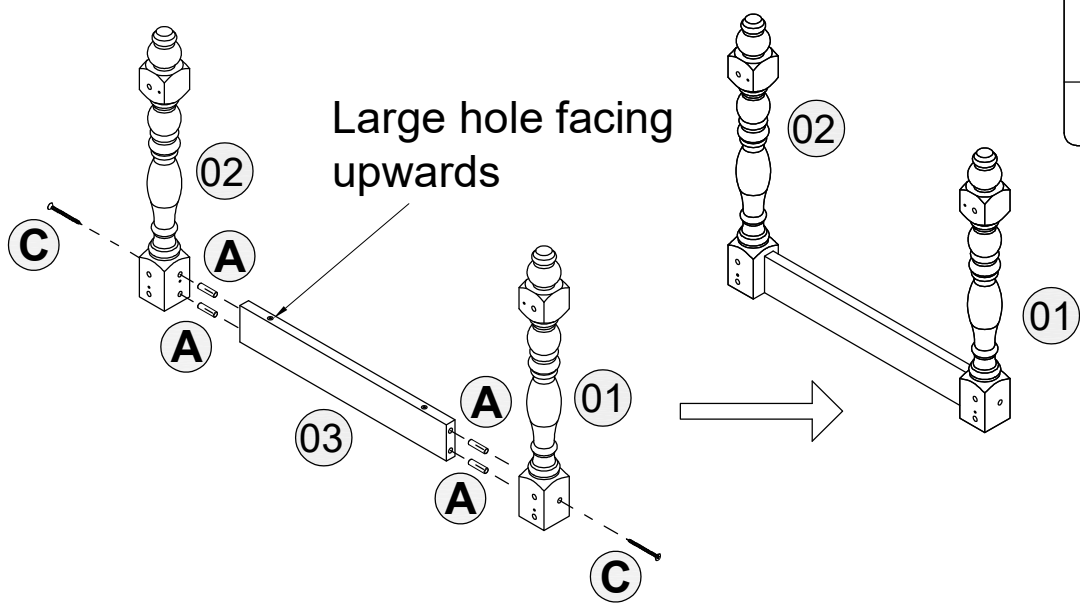

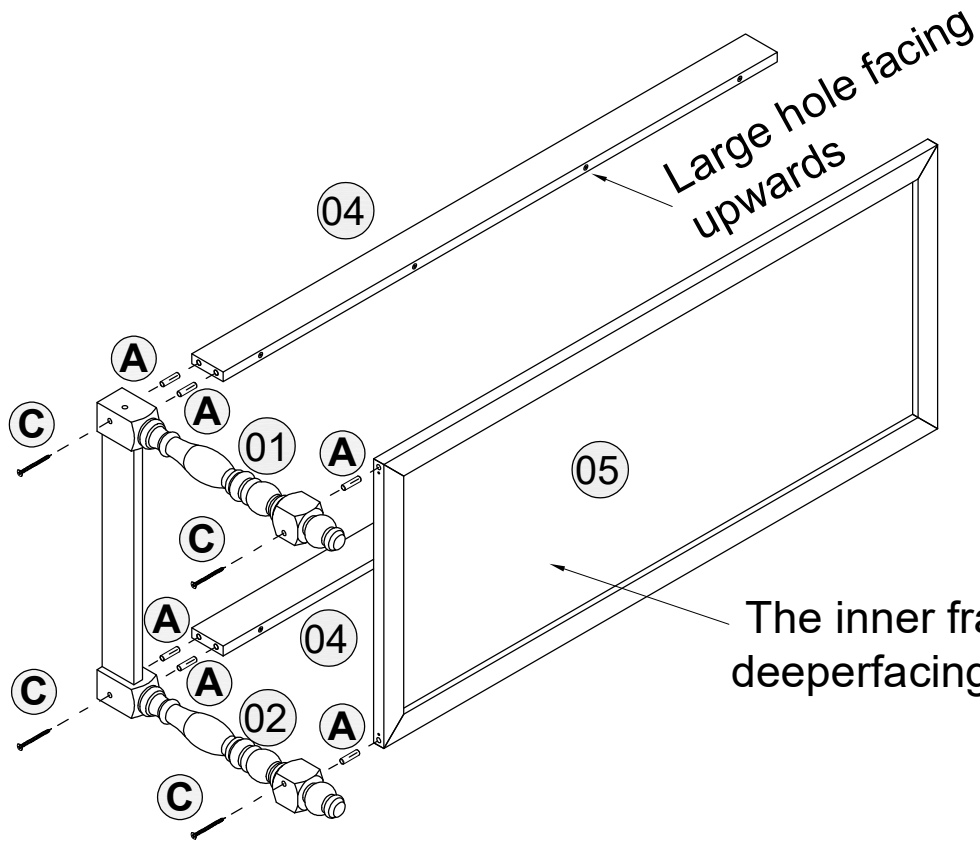

Step 3

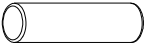
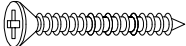

	
Ø8*30	
A	x 6
	
M5*70	
C	x 4

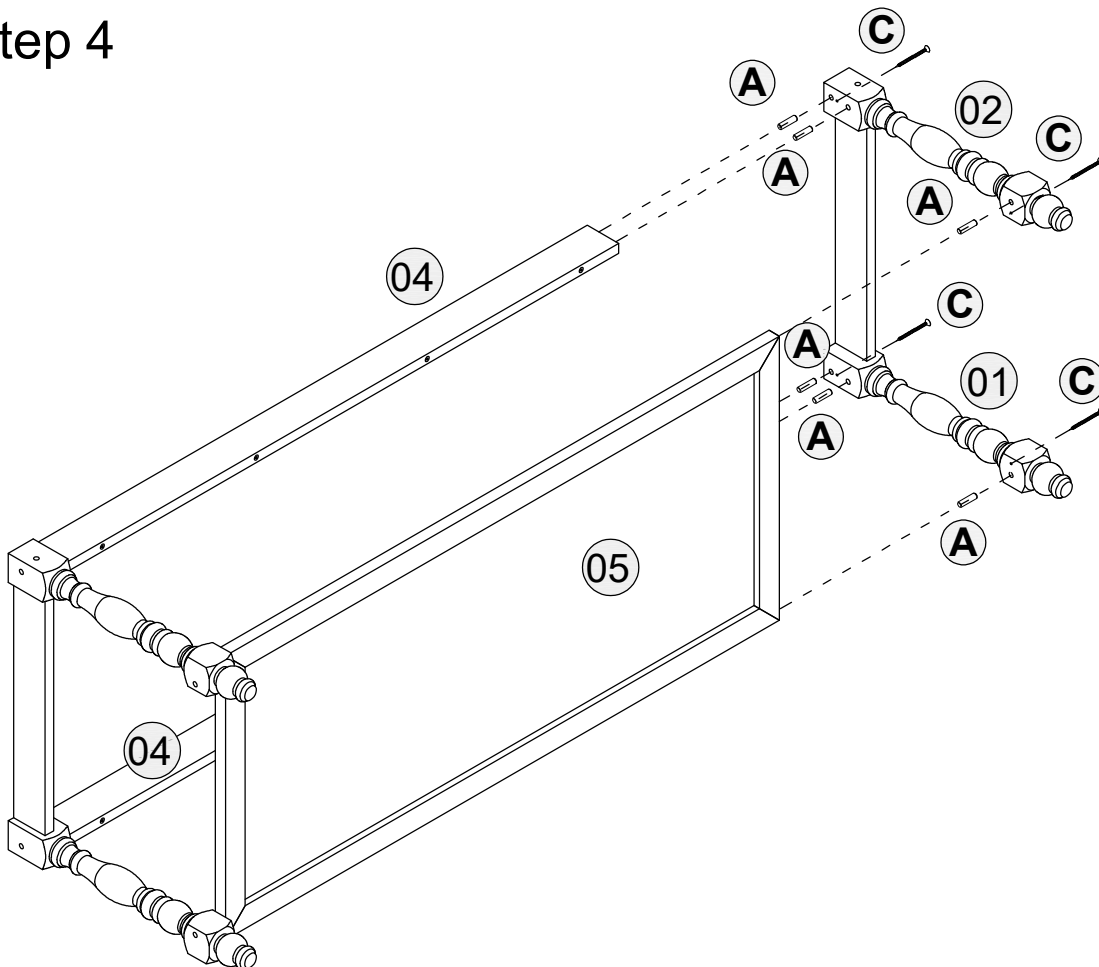
Step 4

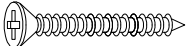

	
Ø8*30	
A	x 6
	
M5*70	
C	x 4

Step 5

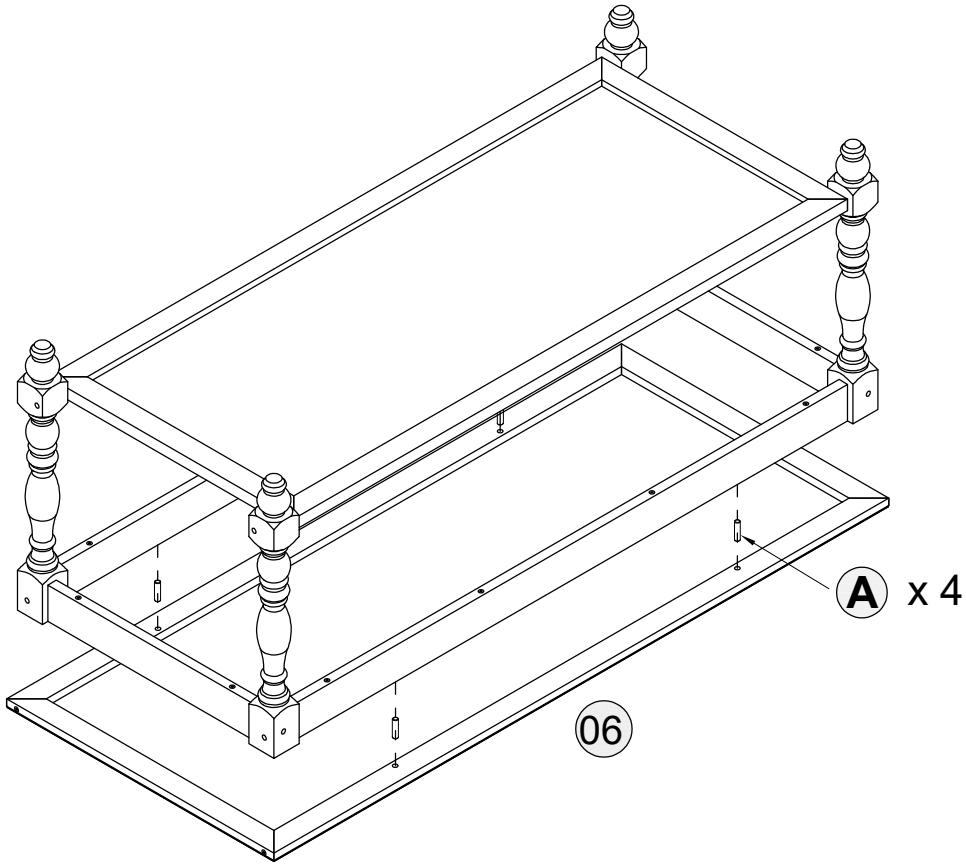

Step 6

