

## DESCRIPTION

- Brass construction
- Flexible supply lines with 3/8" or 9/16" compression fittings
- Includes Red/Blue indicators

## FLOW

- Water usage is limited to these maximum flow rates as indicated by the corresponding product markings
- North America: 1.5 gpm max (5.7L/min) at 60psi
- California: 1.2 gpm max (4.5L/min) at 60psi

## CARTRIDGE

- Ceramic disk cartridge

## STANDARDS

- Certified to CUPC
- Certified to AB1953
- Certified to NSF/ANSI 61
- **ADA**  for lever handle

## WARRANTY

- Lifetime limited warranty against leaks, drips and finish defects to the original consumer purchaser
- 5 year warranty if used in commercial installations

# Specifications

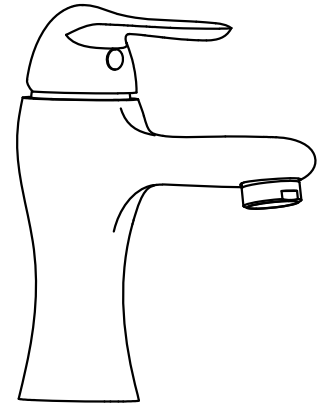

Single-Handle Lavatory Faucet

**NOTE:** THIS FAUCET IS DESIGNED TO BE INSTALLED THRU 1 HOLE,  $\Phi$ 1-3/8" MIN.



| Faucet part  | Guarantee                         | Damage                                      | Solution  |
|--------------|-----------------------------------|---|---|
| Body:        | 10 years guarantee                | Burst, deformation, leakage, dents          | Replace a new one                                 |
| Cartridge:   | 5 years guarantee                 | Leakage, uneven hot and cold water          | Replace new cartridge                             |
| Supply hose: | 5 years guarantee, with insurance | Deformation, burst, connector water leakage | Replace supply hose or seal ring of the connector |
| Aerator:     | 1 year guarantee                  | Leakage, no water or filter water           | Clean or replace the mesh                         |
| O-ring:      | 1 year guarantee                  | Leakage                                     | Replace a new one                                 |

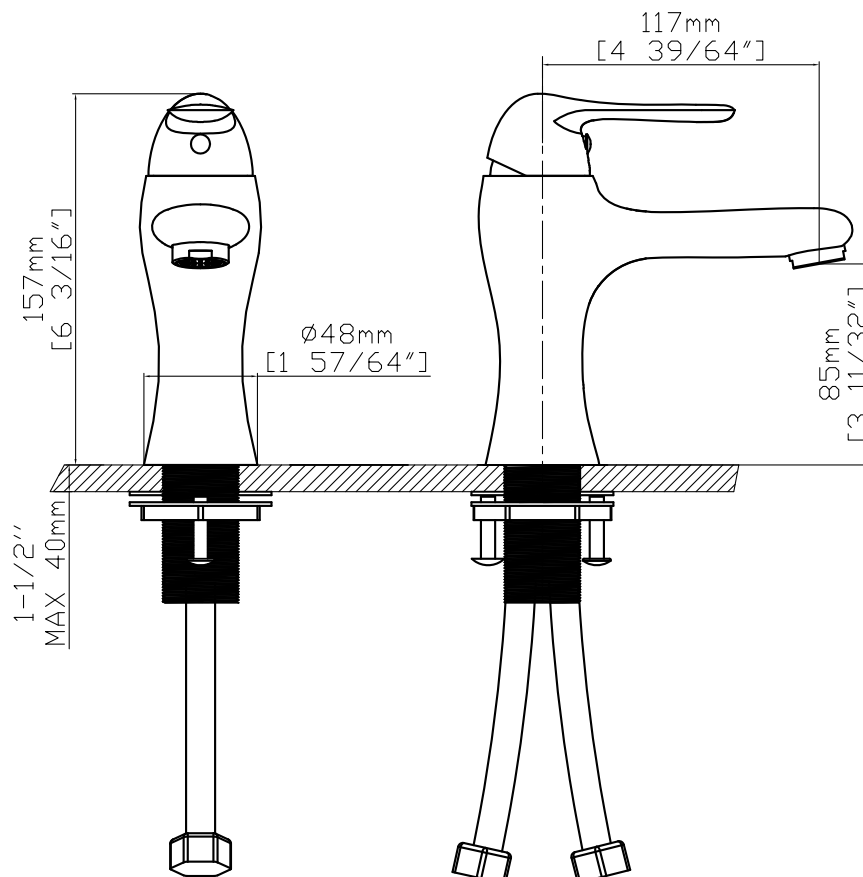

CRITICAL DIMENSIONS

# Single-Handle Lavatory Faucet Installation

## INSTALLATION MANUAL Tools You Will Need :

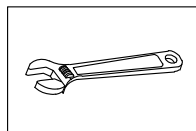

Adjustable wrench

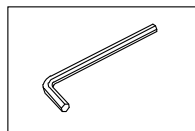

Hexagon wrench

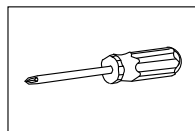

Philips Screwdriver

### Notes before installation :

1. Please check that all components are present.
2. Before installation ensure that all feed lines are clear of debris and on/off valve is present.
3. Ensure water pressure is between 20-125 PSI (includes combination of hot and cold feed lines).
4. Pictures in the manual are general in content and may not represent exactly your purchased faucet. If you are having difficulties please contact a professional plumber.
5. If you will be away from home for an extended period you should shut off the main water supply.

### Daily maintenance

1. Use a soft cloth and vinegar to remove hard-water spots.
2. Check aerator (if present) regularly for calcium build up are when water stream is not optimum.
3. DO NOT use caustic cleaning products as the use will break down finish and will void the product warranty.
4. Acceptable cleaners include vinegar or mild non-abrasive liquid detergents.
5. If the water pressure appears to be less than optimum remove, inspect, clean or replace aerator.

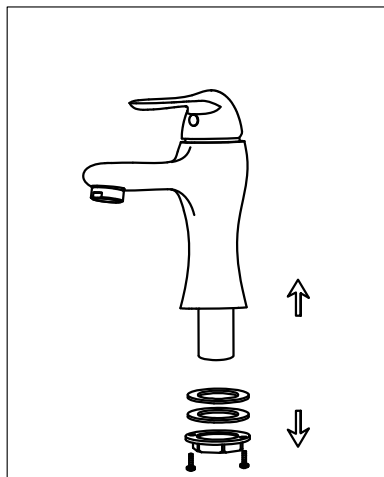

1. Remove the rubber washer, metal washer and locking nut from the faucet.

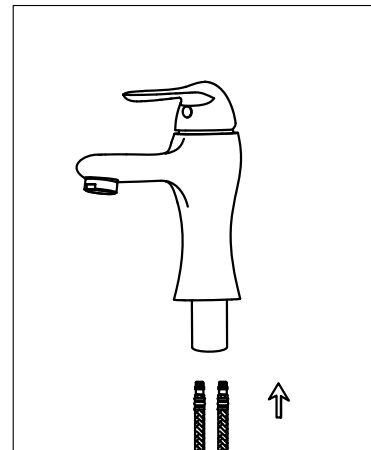

2. Screw and hand tighten the hot and cold flexible hoses to the faucet. DO NOT use a wrench to tighten hoses as this may damage the hose and/or the hose threads.

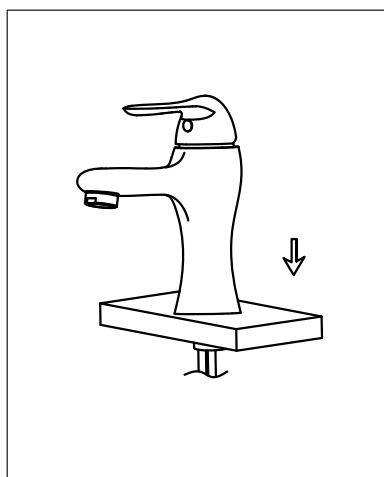

3. Install faucet through center hole .

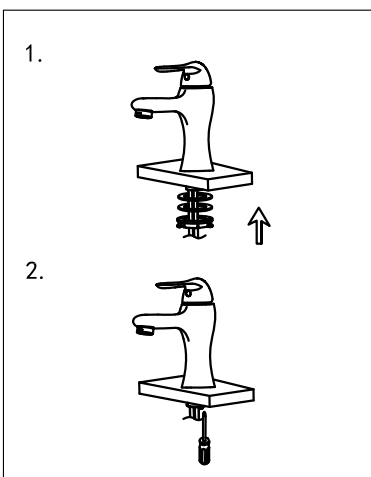

4. Re-install the rubber washer followed by the metal washer and lock-nut. Hand tighten then tighten further using a screw driver to tighten lock-nut screws.

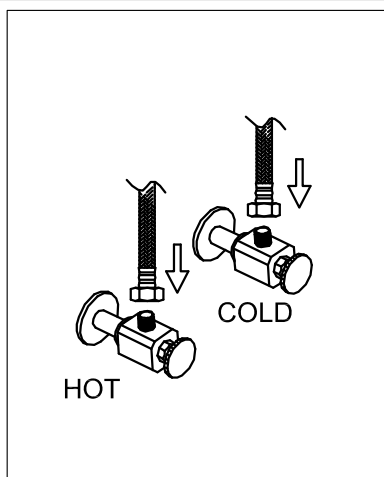

5. Attach flexible hose to water supply.

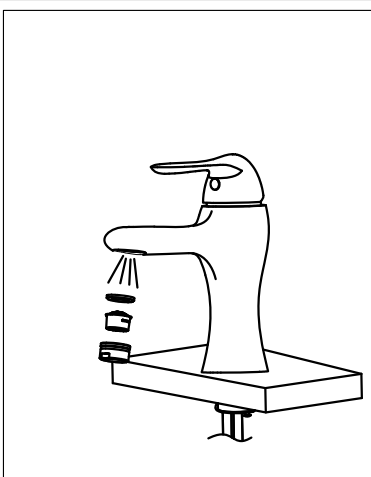

6. Remove the aerator and turn on faucet for 1-minute to flush debris from faucet and feed lines. Turn faucet off and re-install aerator.