









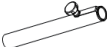

**USER'S MANUAL/HANDBUCH
/MANUEL DE L'UTILISATEUR/MANUAL DEL USUARIO
/MANUALE UTENTE/INSTRUKCJA OBSŁUGI**

Umbrella Stand Table/ Gartentisch mit Schirmständer
/ Table d'Appoint en Rotin / Mesa con Agujero / Tavolino in Rattan
/ Stolik z rattanu

**PARTS AND HARDWARE LIST/TEIL UND HARDWARE-LIATE/
LISTE DES PIÈCES ET MATÉRIEL/LISTA DE PARTES Y ACCESORIOS/ELENCO DEGLI
ACCESSORI E DELLE PARTI/WYKAZ CZĘŚCI I AKCESORIÓW**

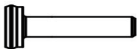
PART/TEIL/ PIÈCE/PARTE PARTE /CZĘŚĆ	FIGURE/ABBILDUNG/ FIGURE/IMAGEN/ FIGURA/RYSUNEK	DESCRIPTION/BESCHREIBUNG /DESCRIPTION/DESCRIPCIÓN/ DESCRIZIONE/OPIS	QTY/MENGE/QTÉ /CANTIDAD/ QUANTITÀ/IŁOŚĆ
A		TABLE TOP/TISCHPLATTE/Dessus de table /SUPERFICIE DE MESA/TAVOLO INFERIORE /BLAT STOŁU	1
B		TABLE LEG/TISCHBEIN/Pied de table/ PIERNA DE MESA/GAMBA DEL TAVOLO/ NOGA STOŁU	2
C		SIDE PANEL/SEITENWAND/Panneau latéral/ PANEL LATERAL/PANNELLO LATERALE/ PANEL BOCZNY	2
D		BOTTOM PANEL/BODENPLATTE/Panneau de base/ PANEL INFERIOR/PANNELLO INFERIORE/ PANEL DOLNY	1
E		UMBRELLA BASE POLE/REGENSCHIRM BASISPOL /Poteau de base de parasol/POSTE BASE PARAGUAS/ PALO DI BASE DELL'OMBRELLO/ PODSTAWKA DO PARASOLU	1
F		PLASTIC UMBRELLA RING/KUNSTSTOFFFREGELRING /Bague plastique de parasol/ ANILLO DE PARAGUAS DE PLÁSTICO/ ANELLO PER OMBRELLO IN PLASTICA/ PIERŚCIEŃ PARASOLA	1
G		M6*15BOLT/M6 * 15 BOLZEN/Boulon M6*15/ M6*15 PERNO/M6*15 BULLONE/M6 * 15 ŚRUBA	8
H		M6*20 BOLT/M6 * 20 BOLZEN/Boulon M6*20/ M6*20 PERNO/M6*20 BULLONE/M6 * 20 ŚRUBA	3
I		M6*28 BOLT/M6 * 28 BOLZEN/Boulon M6*28/ M6*28 PERNO/M6*28 BULLONE/M6 * 28 ŚRUBA	8
J		WASHER/UNTERLEGSCHIEBE/Rondelle/ ARANDELA/RONDELLA/PODKŁADKA	19
K		ALLEN WRENCH/INNENSECHSKANTSCHLÜSSEL /Clé Allen/LLAVE ALLEN/CHIAVE A BRUGOLA/ KLUCZ	1

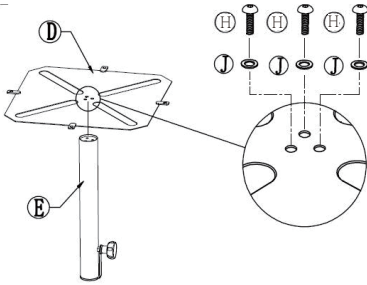
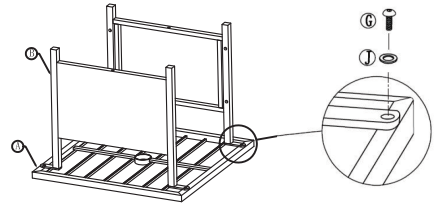
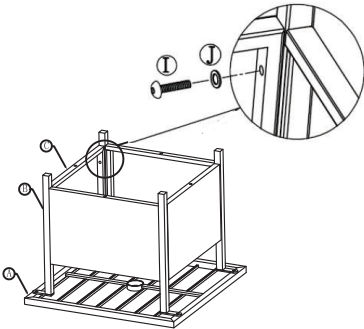
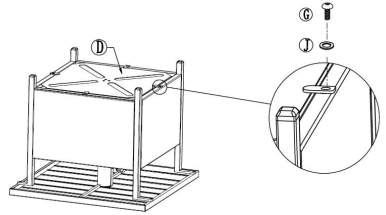
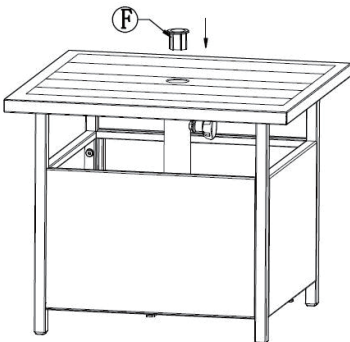
1**2****3****4****5****6**