

"IMPORTANT, RETAIN FOR FUTURE REFERENCE: READ CAREFULLY"

SAFETY GUIDELINES

1. To avoid possible electric shock, turn off the electricity in the main fuse box or on the circuit panel before you begin the fan installation, maintain the fan or install any accessories.
2. Read all instructions and safety guidelines carefully before installing your fan and follow all the instructions.
3. Make sure all electrical connections comply with the local codes or ordinances and the national electrical code. If you are unfamiliar with electric wiring, please consult a qualified licensed electrician.
4. Make sure you have a location that has clear space for the fans' blades to rotate. There is at least seven (7) feet of clearance between the floor and the fan blades' tips. The fan should be mounted at least thirty (30) inches from walls or other upright structures.
5. **⚠ WARNING:** The outlet box and ceiling support joist must be securely mounted, and capable of supporting at least 100 pounds. To reduce the risk of fire, electric shock or personal injury, mount to the outlet box marked "acceptable for fan support" and use mounting screws matching the outlet box. The box must be supported directly by the building structure.
6. **⚠ WARNING:** To reduce the risk of fire, electric shock or personal injury, mount to the outlet box marked "acceptable for fan support" and use mounting screws matching the outlet box. Most outlet boxes are only used for supporting lighting fixtures and not acceptable for fan support. Consult a qualified electrician if in doubt.
7. Electrical diagrams are for reference only. Light kits don't come with the fan. It must be UL listed and marked "suitable for use with the fan model you are installing". Switches must be UL general switches. Refer to the instructions to properly assemble the fan.
8. After installing, check that all connections are firmly secured.
9. After making electrical connections, the spliced conductors should be turned upward and carefully pushed up into outlet box. The wires should be placed separate from the grounded conductor as well as the equipment-grounding conductor on opposite side of the outlet box.
10. **⚠ WARNING:** To reduce the risk of electrical shock and fire, do not use this fan with any solid-state fan speed control device, or rheostat.
11. Do not operate the reverse switch until the fan has come to a complete stop.
12. Do not insert anything into the fan's blades while they are rotating.
13. **⚠ WARNING:** To reduce the risk of personal injury, do not bend the blade brackets (also referred to as "flanges") during assembly or after installation. Do not insert objects between the blades.
14. To avoid personal injury or damage to the fan and other items, be cautious when working around or cleaning the fan.
15. Do not use water or detergent to clean the fan or its blades. A dry or lightly dampened cloth will be more suitable.

NOTE: The important safety precautions and instructions on the manual are not meant to cover all possible conditions and situations that may occur. It is understood that common sense and caution are necessary factors during installing and operating the fan.

NOTE: This product is not intended for persons who have badly physical sensory or mental capabilities, or lack certain life experience and knowledge, especially children. Unless such persons are supervised or trained to operate the appliance under the guidance of a person who is responsible for their safety.

NOTE: Children should be supervised to ensure that they do not use appliances as toys.

NOTE: You must install a switch or circuit breaker that disconnects all power poles, at least 3 mm between each pole.

BEFORE YOU START

Contact a licensed electrician if you are not good at performing electrical work. It's the licensed electrician who installs the fan, if required by the local code. Do not use the fan with a dimmer switch. Turn off power at breaker.

BEFORE YOU START

Contact a licensed electrician if you are not good at performing electrical work. It's the licensed electrician who installs the fan, if required by the local code. Do not use the fan with a dimmer switch. Turn off power at breaker.

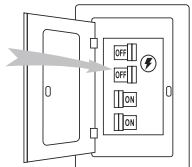

Tools and Materials Required





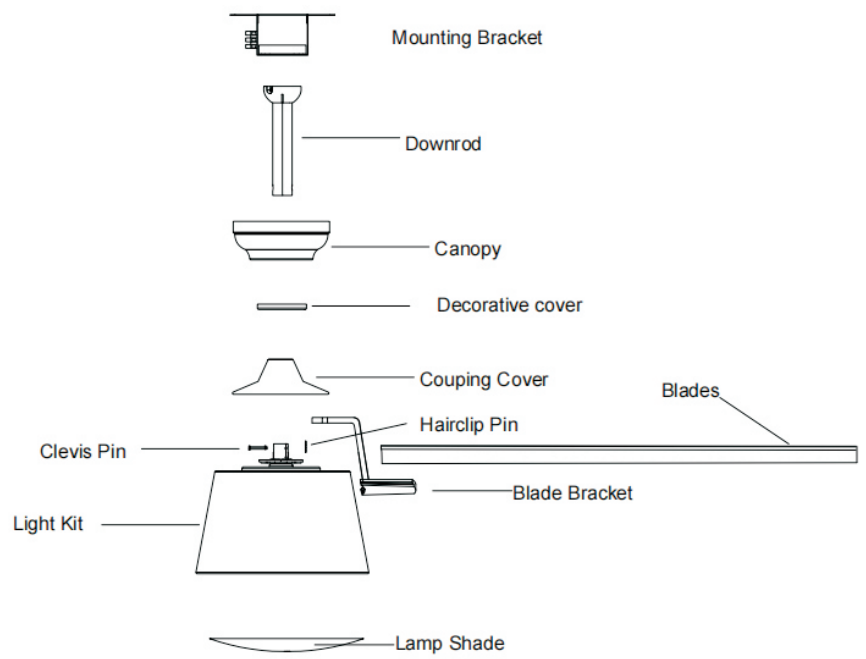





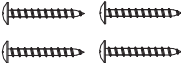

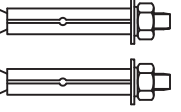
Product Instruction

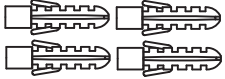

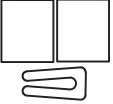
REMOTE CONTROL(1PC S)

SCREWS BAG

Item no.	Reference Image	Qty.	Item no.	Reference Image	Qty.
①	 <p style="text-align: center;">ST5x35 Setscrew</p>	×4	⑦	 <p style="text-align: center;">Ø4 Screw Washer</p>	× 2
②	 <p style="text-align: center;">Expansion Screw</p>	×2	⑧	 <p style="text-align: center;">Ø5 Screw Spring Washer</p>	× 4
③	 <p style="text-align: center;">Setscrew Stopper</p>	×4	⑨	 <p style="text-align: center;">Ø4 Screw Spring Washer</p>	×2
④	 <p style="text-align: center;">Wire Cap</p>	× 3	⑩	 <p style="text-align: center;">Balance Pack</p>	×2
⑤	 <p style="text-align: center;">#8-32 Setscrew</p>	×2	⑪	 <p style="text-align: center;">Fabric Washer</p>	×16
⑥	 <p style="text-align: center;">Ø5 Screw Setscrew</p>	×4	⑫	 <p style="text-align: center;">Screws for Blades</p>	×16

INSTALLING THE FAN

Tools Required: Phillips screwdriver, a pair of pliers, straight slot screwdriver, adjustable wrench, step ladder, and wire cutters.

INSTALLING THE MOUNTING BRACKET

The ceiling fan must be installed in the location where there is 12" (300mm) spacing from the tips of all blades to the nearest objects or walls. REMEMBER to turn off the power before hanging the fan. Follow the instruction below to hang your fan properly:

- For concrete ceiling, drill two holes in the ceiling and secure the mounting bracket to the ceiling with two $\phi 0.32"$ (8mm) (distance between the two holes should be appropriate) expansion screws, flat washers nuts provided and tighten with a spanner.

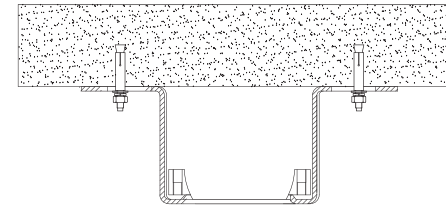

- For wood ceiling, secure the mounting bracket to the ceiling that is capable of carrying a load of at least 100lbs (45kgs) with two long mounting screws and washers provided. Be sure at least 0.12" (30mm) of the screw is threaded into the support.

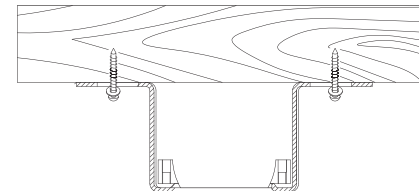

- For installing the outlet box, secure it directly to the building structure. Use appropriate fasteners and building materials. The outlet box and its support must be able to fully bear the moving weight of the fan (at least 100lbs). Use a UL listed metal outlet box instead of plastic ones. Figure 1& 2 show the examples of mounting the outlet box.

MAKE THE ELECTRIC CONNECTIONS

⚠ WARNING: To avoid possible electrical shock, be sure the electricity is turned off in the main fuse box before wiring.

1. Connect the fan to the remote control. The fan's 3P plug should insert into the the remote control's 3P plug.
2. Connect the remote control to the house's power line, then connect the remote control's white wire to the house's white wire. Connect the remote control's black wire to the house's black wire, and connect all the fans' green ground wires to the house of ground wires. Secure wires.
3. Connect the light to the remote control. The light's 3p should insert into the remote's 3p plug.

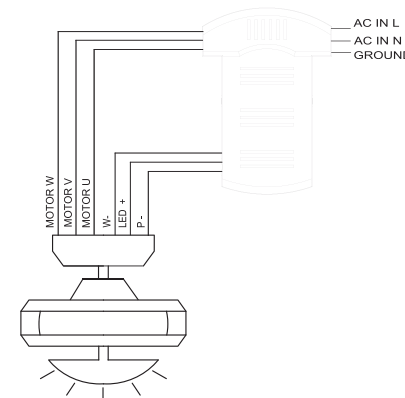
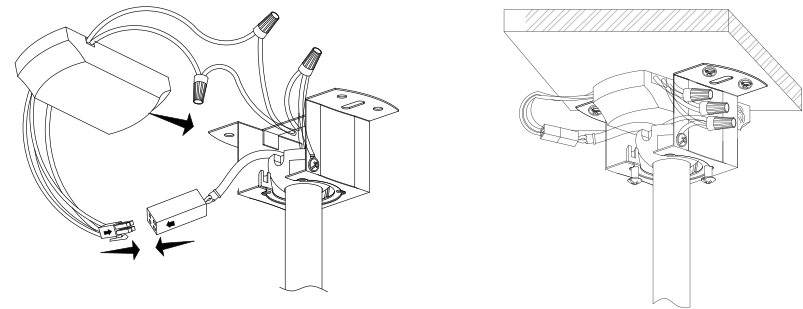

INSTALLING THE CANOPY

Loosen the 2 screws on the bottom of mounting bracket but do not remove them. Raise the canopy up and align the keyholes on the bottom of the canopy with the 2 screws on the bottom of mounting bracket.

Rotate the canopy until both screws from the mounting bracket drop into the slot recesses. Tighten screws.

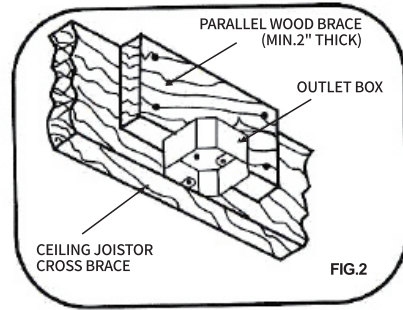
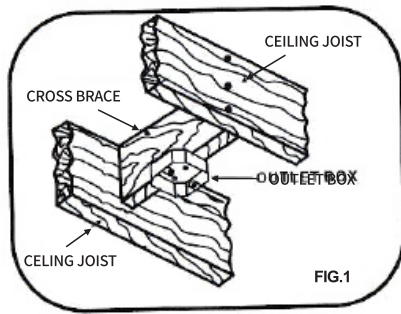
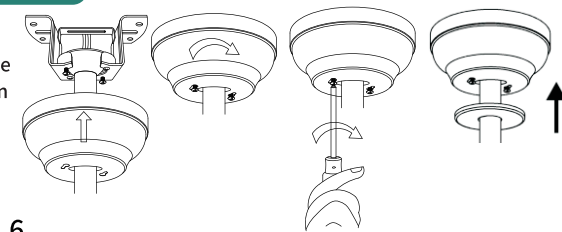

4. Refer to the Fig. on the right to mount when the ceiling is angled (Max. 15°).

NOTE: The hanger must be able to withstand the weight of 100lbs (45kgs) or more after the installation

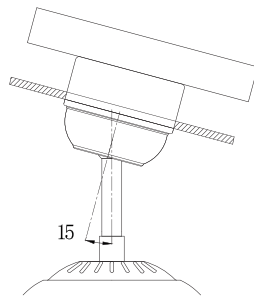

INSTALLING THE FAN TO MOUNTING BRACKET ON CEILING

⚠ WARNING: To avoid possible electrical shock, be sure the electricity is turned off in the main fuse box before wiring.

Carefully lift the fan assembly onto mounting bracket and rotate the fan until the notch on downrod ball "1" engages the ridge on the mounting bracket "2".

This will allow for hands free wiring.

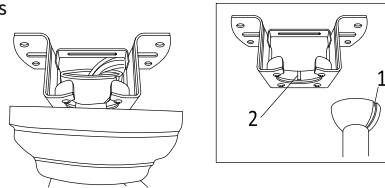

INSTALLING THE LIGHT KIT

- 1.Remove 3 mounting screws from the light kit.
- 2.Find the Molex connector from the motor and the Molex connector from the light kit. Slide them together.
- 3.Install 3 screws to the motor' s junction box and light kit tightly.
- 4.Carefully install the glass shade into the main body and turn clockwise to lock.

⚠ WARNING: Take care not to over tighten when installing the glass shade.

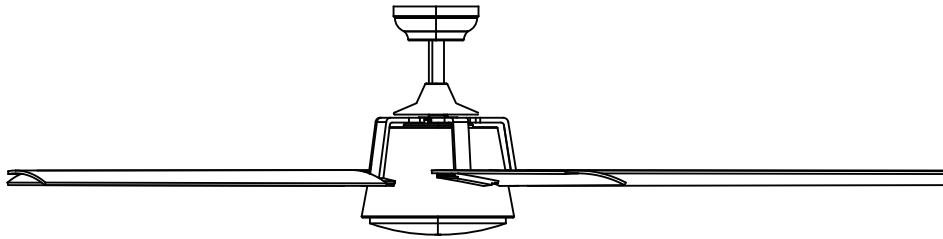

1

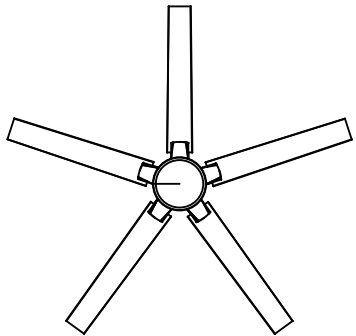

2

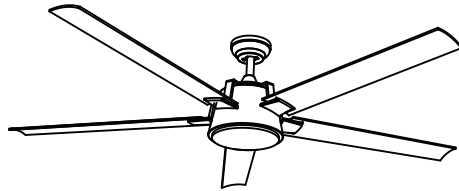

3

Installation is now finished. Turn on the power switch as Fig 7. Then the fan lights are on. Test and pair your fan immediately using the remote control.

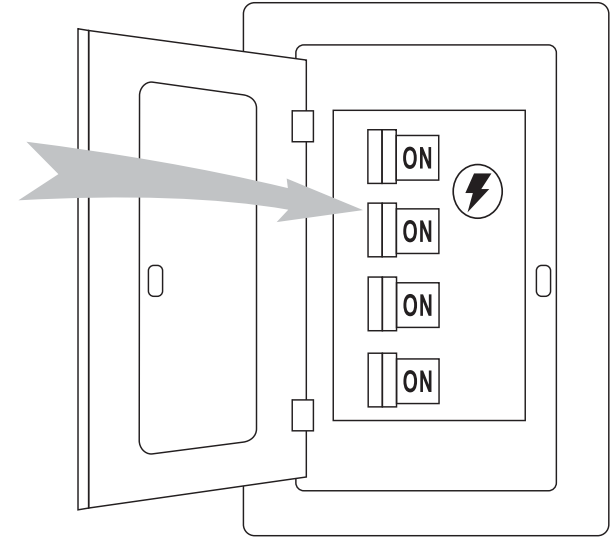

NOTE: Wait for the fan to stop before reversing the direction of the blade rotation

- A. Warm weather-(Forward) A downward airflow creates a cooling effect. This allows you to set your air conditioner on a higher setting without affecting your comfort.
- B. Cool weather-(Reverse) An upward airflow moves warm air off the ceiling.This allows you to set heating unit on a lower setting without affecting your comfort.

REMOTE CONTROL SETTING AND OPERATION

OPERATING TRANSMITTER:

- Install LR03/AAA1.5V*2 volt battery(not included).(To prevent damage to transmitter, remove the battery if not used for a long time).
- Store the transmitter away from excessive heat or humidity.
- Operating the buttons on the panel of the transmitter.

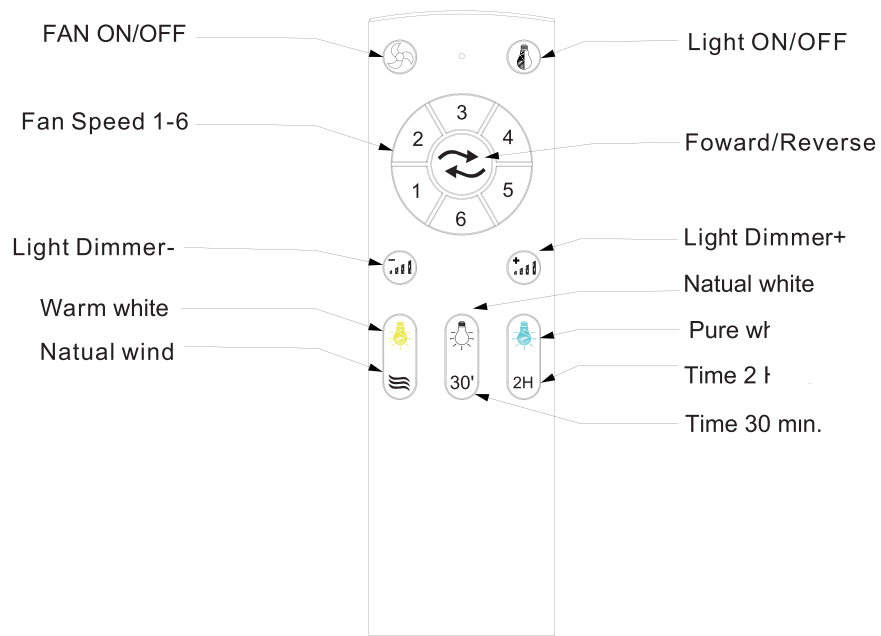

D. Setting the codes on the receiver:

- Learning code matching mode is used between REMOTE CONTROL and receiver. Turn on the supply power within 5 seconds and press the REMOTE CONTROL “FAN ON/OFF” button for 3 seconds, it can load normally after hearing a long sound “bee” , which means learning successfully and it can works normally. (PS: Learning mode is not accepted after turn “ON” the supply power for 5 seconds)

WALL CONTROL SWITCH SETTING AND OPERATION

OPERATING TRANSMITTER:

- Install LR03/AAA1.5V*2 volt battery(not included). (To prevent damage to transmitter, remove the battery if not used for a long time).
- Store the transmitter away from excessive heat or humidity.
- Operating the buttons on the panel of the transmitter.

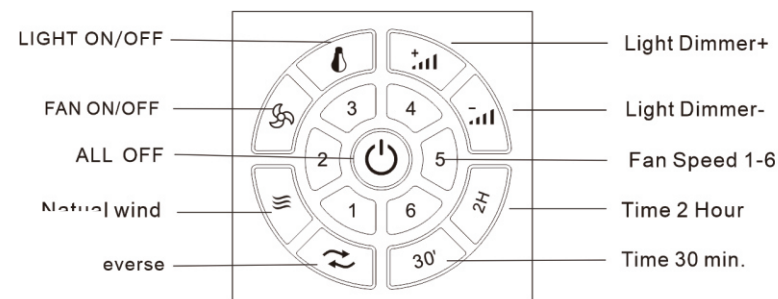

D. Setting the codes on the receiver:

- Learning code matching mode is used between REMOTE CONTROL and receiver. Turn on the supply power within 5 seconds and press the REMOTE CONTROL “FAN ON/OFF” button for 3 seconds, it can load normally after hearing a long sound “bee” , which means learning successfully and it can works normally. (PS: Learning mode is not accepted after turn “ON” the supply power for 5 seconds)

HOW TO USE BALANCING KITS

NOTE: CEILING FANS TEND TO MOVE DURING OPERATION DUE TO THE FACT THAT THEY ARE MOUNTED ON A RUBBER CROMMET. IF THE FAN WAS MOUNTED RIGIDLY TO THE CEILING, IT WOULD CAUSE EXCESS VIBRATION, MOVEMENT OF A FEW CENTIMETERS IS QUITE ACCEPTABLE AND DOES NOT SUGGEST ANY PROBLEMS

TO REDUCE FAN WOBBLE: PLEASE CHECK THAT ALL SCREWS WHICH SECURE THE MOUNTING BRACKET AND DOWNROD ARE SECURE

BALANCING A WOBBLING CEILING FAN

For your convenience, a balancing kit is included: please follow this procedure when balancing the fan:

1. Check that all blades and blade arm screws are secure.
2. Most fan wobbling problems result from blade levels are unequal. Check this level by selecting a point on the ceiling above one fan blade's tip. Measure this distance. Rotate the fan until the next blade is positioned for measurement. Repeat for each blade. The distance deviation should be equal within 1/8" (0.32cm).
3. Use the enclosed blade balancing kit if the blade wobbling is still noticeable.
4. If the blade wobble is still noticeable, interchanging two adjacent (side by side) blades can redistribute the weight and possibly result in smooth operation.

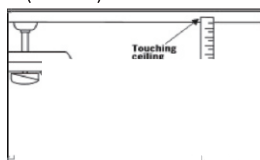

⚠ WARNING: TO REDUCE THE RISK OF PERSONAL INJURY, DO NOT BEND THE BLADE ARM WHILE INSTALLING, BALANCING THE BLADES, OR CLEANING THE FAN. DO NOT INSERT OBJECTS BETWEEN ROTATING FAN BLADES

NOISE

It's normal to hear small occasional noises when in quiet night or days. Please allow a 24-hour "breaking-in" period, most noises of a new fan disappear during the time.

MAINTENANCE AND CLEANING

1. Periodically cleaning your ceiling fan is the only required maintenance. Use a soft brush or lint free cloth to avoid scratching the paint. Please turn off the electricity power before you clean your fan.
2. Do not use water when cleaning your ceiling fan. It could damage the motor or the blades or even evoke an electrical shock.
3. The motor has permanently lubricated ball bearing. No need to oil

NOTE: MAKE SURE THE POWER IS OFF IN THE ELECTRICAL PANEL BOX BEFORE YOU DO ANY CLEANING OR REPAIRS

TROUBLESHOOTING

Your fan may occasionally jerk forward or backward upon starting up.

This is normal and does not affect the fan operation.

Try these troubleshooting steps before contacting customer service.

SYMPTOM	POSSIBLE SOLUTIONS
The fan doesn't spin	<ol style="list-style-type: none"> 1. Make sure the fan is getting power. 2. Check the functionality of circuit breaker or fuse panel and wall switch. 3. Confirm fan wires are correctly connected to the house wires. 4. Make sure the blocker of the fan motor is removed. 5. Use your remote to check the power to the breaker and try to work your ceiling fan manually from afar (Normal switch only for the fan power on/off)
The fan's light does not work	<p>Make sure the LED light kit and light bulb are connected well.</p> <ol style="list-style-type: none"> 1. Confirm the blade screws are NOT rubbing against the the motor's round plastic part. 2. Confirm the pin wire are NOT connected against the moving part. 3. Confirm the coupling cover is NOT hitting the motor 4. Confirm the down rod is NOT slanted 5. Tighten any loose screws on the light kit, fan blades, motor coupling, down rod, brackets and mounting hardware. 6. Confirm the hanger ball is firmly seated in the mounting bracket. 7. The ceiling beam must meet the minimum tensile test strength of 30KG for installation. 8. Make sure the airfoils and brackets are NOT bent or deformed. 9. Confirm the wire connections are not rattling against each other. 10. Confirm the fan blades are not cracked. If the fan blades are cracked, replace the damaged blades with the set of new blades of same brand as your ceiling fan ensures the compatibility. 11. Change fan blades' positions. 12. Confirm the light kit is NOT slanting and hitting the motor. 13. Confirm all the blades are screwed firmly into blade holders.
The fan is noisy and wobbling	<ol style="list-style-type: none"> 1. Confirm the circuit breaker is not malfunctioning. 2. Confirm the wire connections are not frayed. 3. Confirm the app does not set the timer or schedule 4. Power off the fan for 10 minutes, then power on again.
The fan or light automatically turns on/off	<ol style="list-style-type: none"> 1. Confirm the circuit breaker is not malfunctioning. 2. Confirm the wire connections are not frayed. 3. Confirm the app does not set the timer or schedule 4. Power off the fan for 10 minutes, then power on again.