

COURTYARD GAZEBO

CANOPY GAZEBO WITH NETTING AND
PRIVACY SCREEN

10*10FT

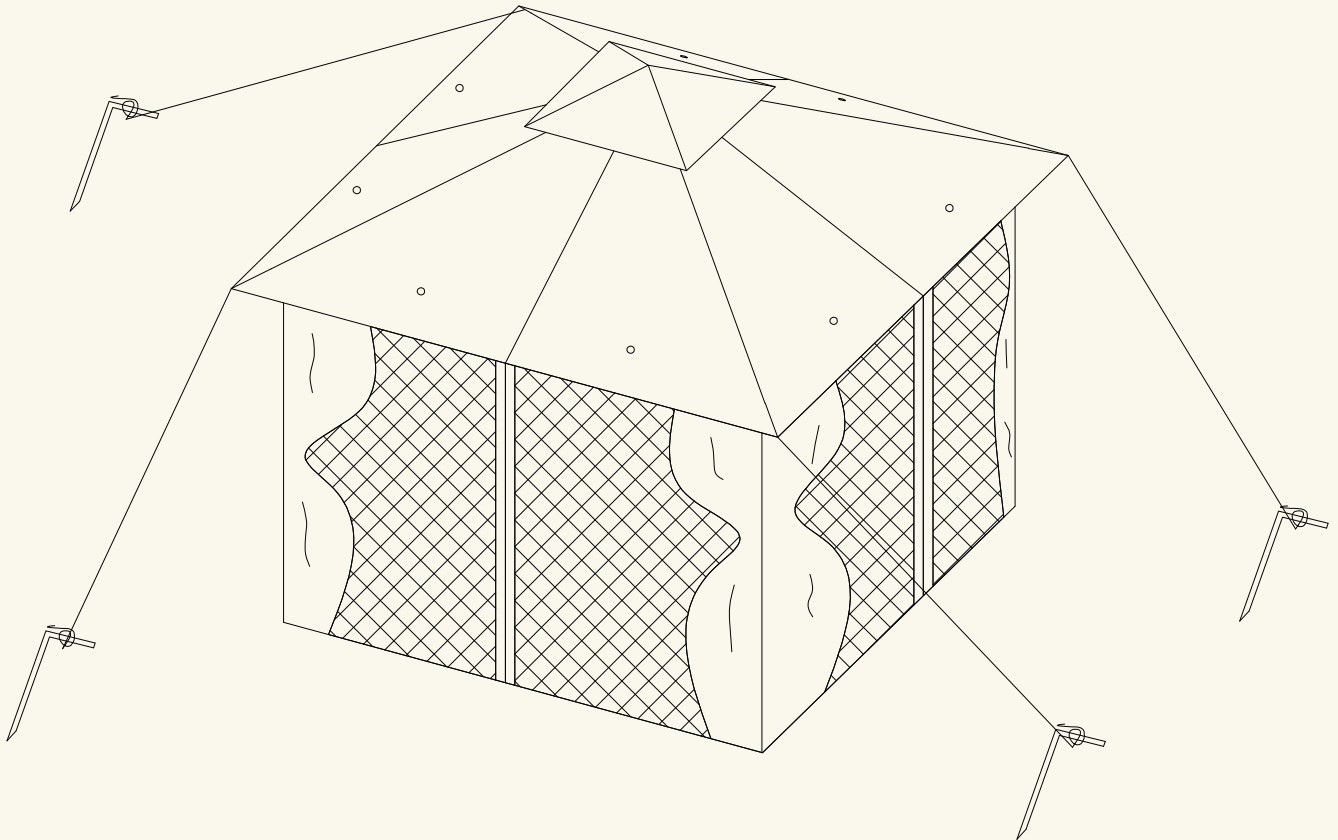

CONTACT US:24H,Mon~Sun.

 service@kmcglobe-us.com

 (USA) +1 213-816-4788

CUSTOMER SUPPORT

Dear customer

Thank you for your purchase.

This product is a non-permanent outdoor structure designed and manufactured for personal use rather than commercial use.

Please confirm whether the installation is permitted in your states firstly.

1. When you receive the product, please make sure that all the boxes have arrived, and all the parts are intact.
2. Please browse the entire installation manual before assembling, retain this instruction manual for future reference.
3. If any problem occurs unsatisfactorily as follows:
 - Lack of boxes, or some boxes are not arrived.
 - The outer box is damaged.
 - The product is damaged / bent / cracked while you open the box.
 - The parts / accessories / assembly tools are missing.
 - The product is hard to assemble.
 - The instructions are not clear, or hoping for assistance with installation.
 - The product has functional problems.
 - The product did not meet your expectations.
 - Other aspects that you are not satisfied with.

Please feel free to contact us for help firstly. If there is any damage, please send us clear photos. We will check and do our best to provide the best solution for you. The missing or damaged parts will be delivered to you within 5 days.

**DO NOT RETURN YOUR UNIT TO THE STORE
CONTACT US FIRST**



service@kmcglobe-us.com



(USA) +1 213-816-4788

ATTENTION

PREPARATION :

The gazebo needs to be installed in cooperation with **two people**.

Estimated Assembly Time: **2-3 Hours**.

Site preparation suggestion: Level the ground surface, construct a wooden or concrete base as a foundation.

The following installation tools will be used.



2 m Adjustable Ladder



Tape Measure



Screw Driver



Pistol Drill



gradienter



Hammer



gloves



2 people

Minimum foundation size:

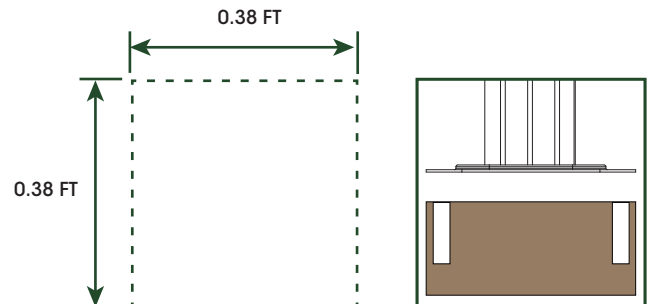
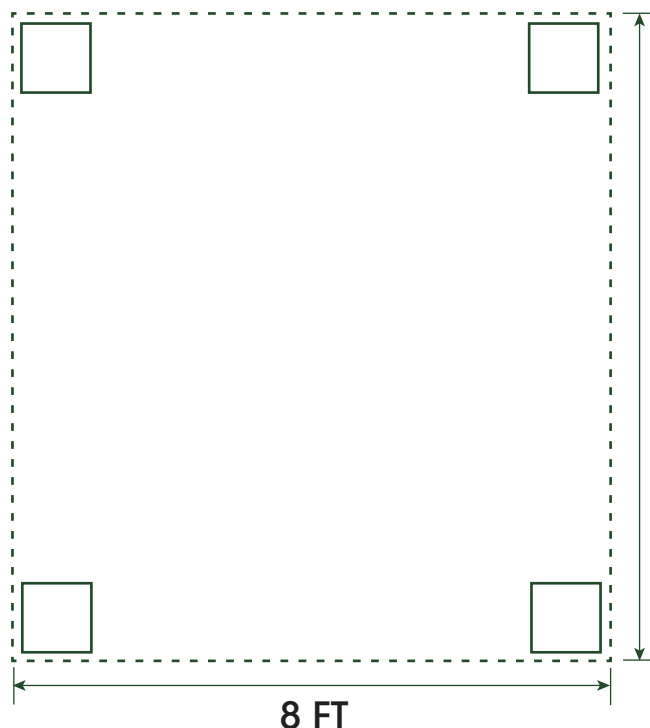

If your foundation is made of hardwood or concrete, Use an 6 mm diameter drill bit to drill holes in the foundation, with the depth exceeding 60 mm.

8 FT

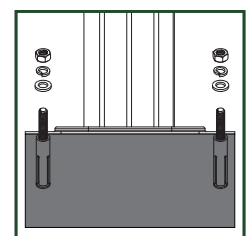
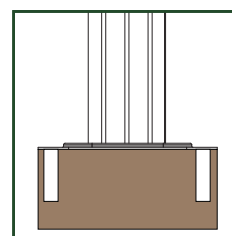

Use the expansion bolts that are pre-configured with the product to secure it in place. This installation methods will provide better wind resistance performance, extend the product's lifespan.

ATTENTION

CAUTION:

1. Tighten each bolt firmly and properly. Do not completely tighten the screws until all screws are started.
2. Some parts may contain sharp edges. Wear protective gloves in the box as necessary.
3. Children under the age of 16 should not be engaged in the assembly, removal or disassembly of the product.
4. It is strongly recommended to hire a professional installation team.

WARNING:

1. Children under the age of 10 should be supervised by a competent adult while using this furniture.
2. Please keep children out of the assembly area during assembly.
3. Never use this product as a support. Do not shake, lean, or climb on the product any time.
4. Please take appropriate measures to deal with the bad weather. Heavy rain, wind and snow may damage the gazebo. If necessary please dis-assemble and store for later use.
5. In snowy weather, please ensure that the thickness of snow on the roof does not exceed 5 inches, If it does, please remove the snow as soon as possible to ensure safety.
6. When the wind force reaches scale 8, please take corresponding measures to reinforce the gazebo to prevent it from being damaged by the wind, and be cautious of safety issues during strong wind conditions.
7. It is necessary to use anchor bolts, expansion bolts and ropes to fix the gazebo to the foundation for Long-term stability.
8. We offer a one-year warranty, excluding damages caused by improper installation, incorrect usage, failure to use the fixing accessories, unclean snow, or failure to take preventive measures.
9. Stay away from open flames.

PARTS LIST

1. Please ensure that all parts, accessories and installation tools are complete before starting the installation.
2. Due to the variety of accessories, some parts may be glued together, some parts may be trapped inside the larger ones, please check carefully.
3. In case you cannot find or lose some small parts or screws during installation, we have provided extra parts, it is a bag with "Additional Parts" label.
4. If any accessories are missing or damaged, please contact us immediately.

✉ service@kmcglobe-us.com

CARTON: A

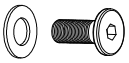

M6X10mm
1 X 24+1



M6X40mm
2 X 16+1

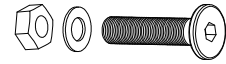

M6X35mm
3 X 8+1

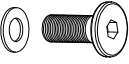

M6x16mm
4 X 64+2

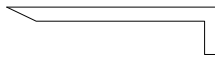

5 X 8

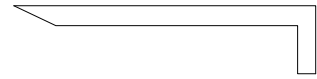

6 X 4



φ5
7 X 4

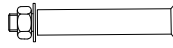

M6x50mm
8 X 8

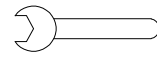

M6
9 X 1



M6
10 X 2



M6x50mm
11 X 16+1

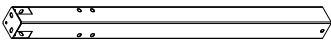

A X 4



B X 8



C X 4



L=255mm
C1 X 4

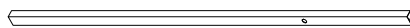

L=1610mm
C2 X 4



D X 4

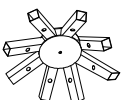

E X 1



F X 4



G X 8

PARTS LIST

CARTON: A

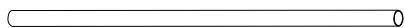

L=1017mm

H X 8

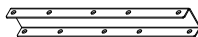

I X 4



J X 8



K X 16

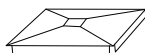

Q X 1



L X 1

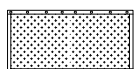

R X 1(4pcs)



M X 32

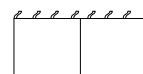

S X 1(4pcs)

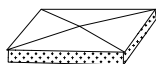

P X 1



200mm

T X 4

Phase 1 : Flooring Frame

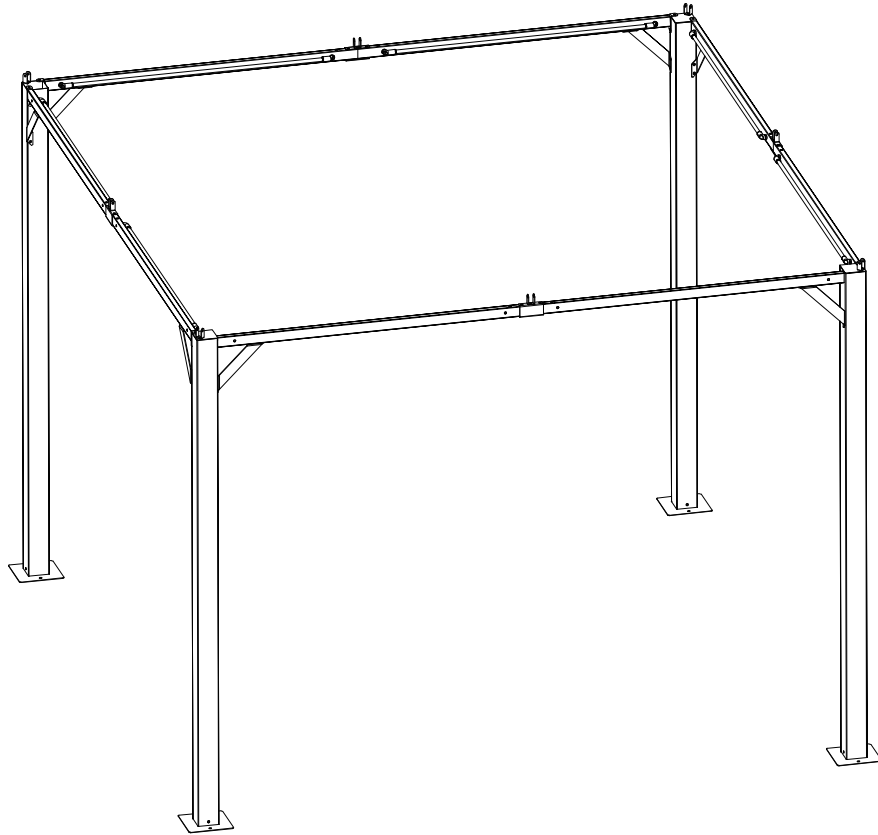

01
STEP
x4

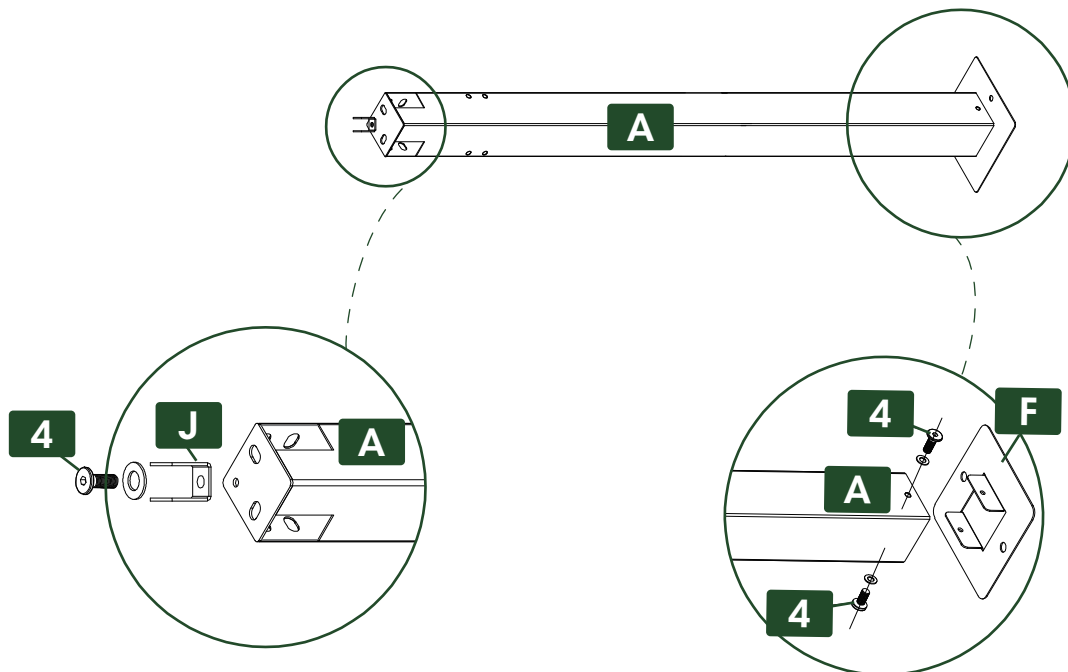

 **4** X 12

02
STEP
X8

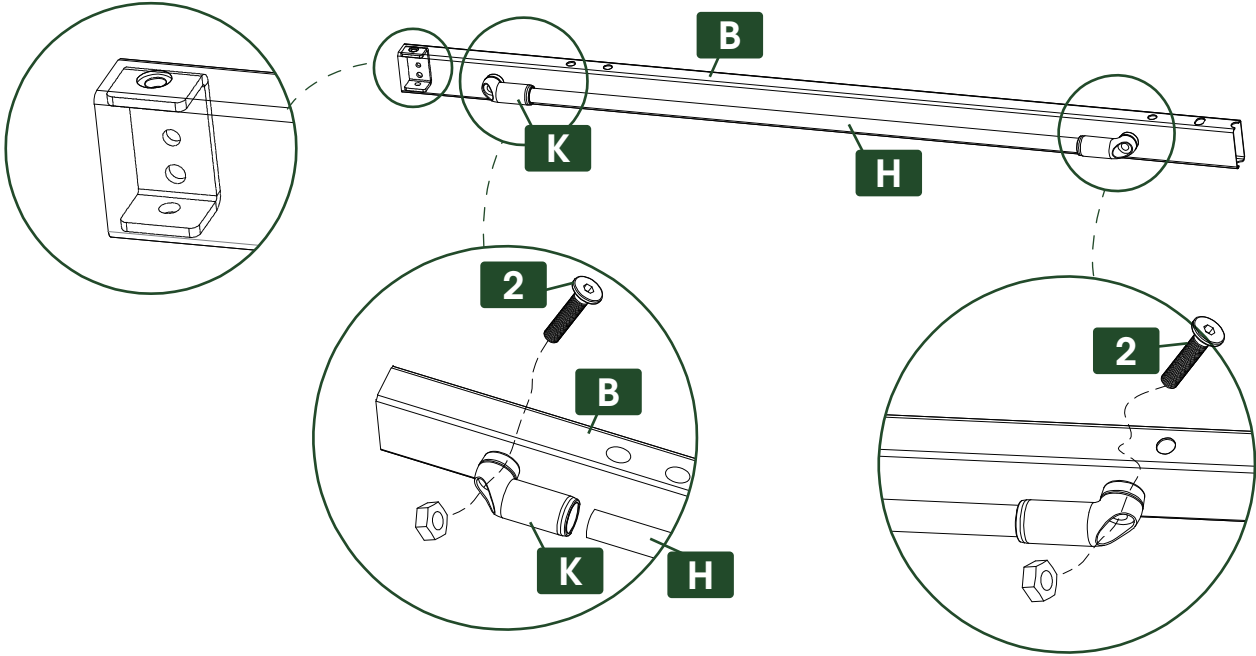
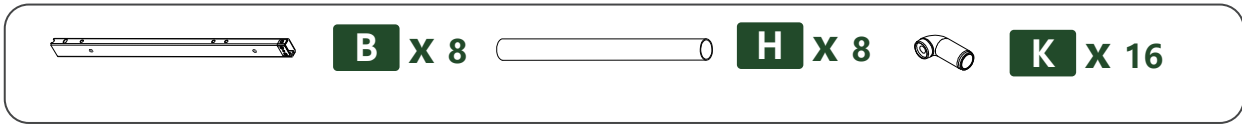

03
STEP
X2

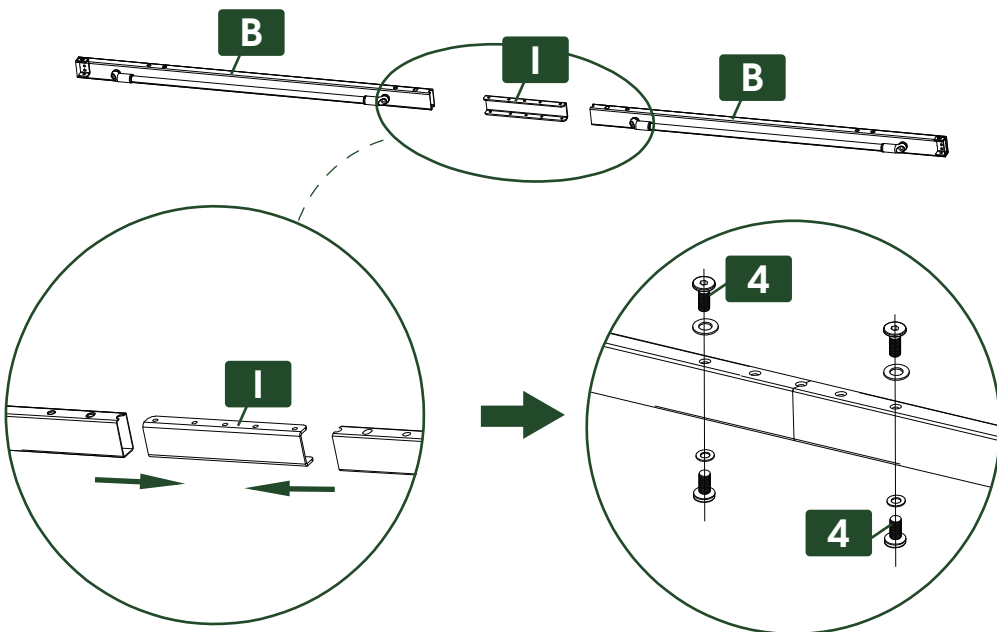

04
STEP
X2

 **D** X 2  **J** X 2

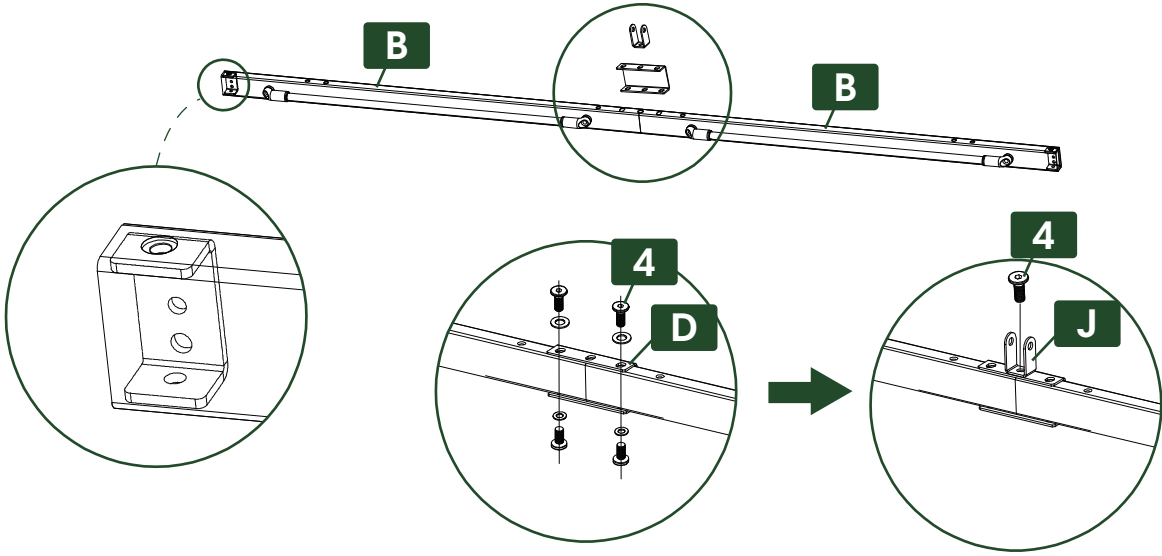



 **4** X 10

05
STEP
X2

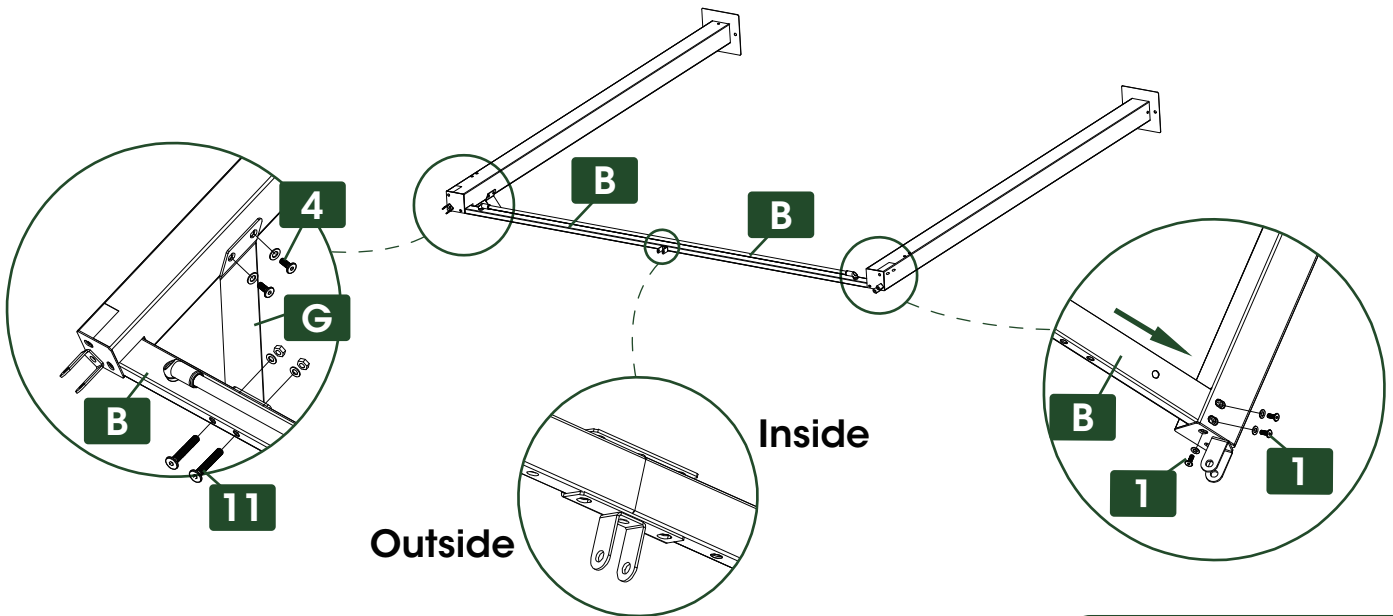
 **G** X 4



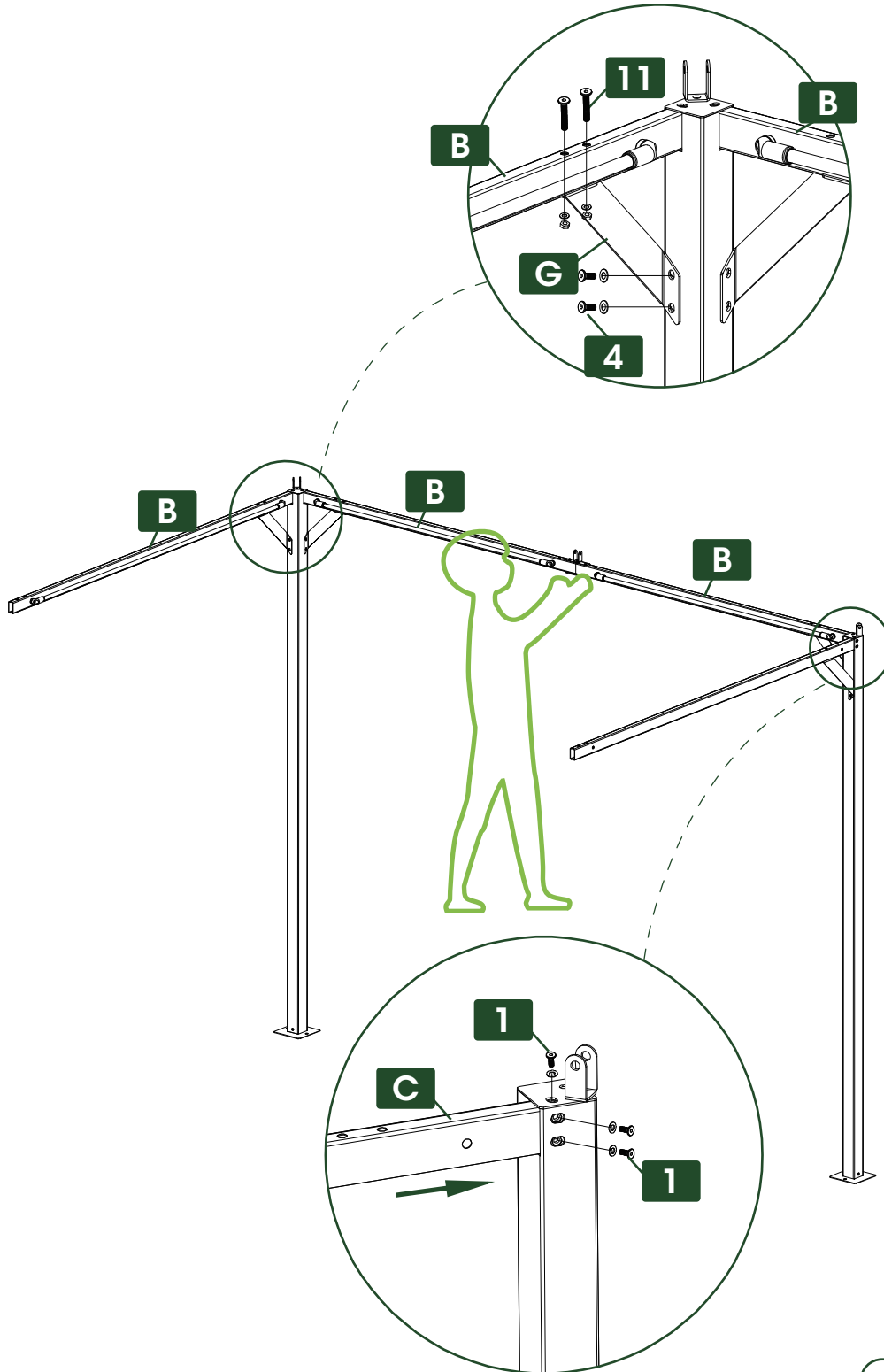

 **11** X 8
 **1** X 12
 **4** X 8

06
STEP
X2



- 11** X 8
- 1** X 12
- 4** X 8

07
STEP

 **I** X 2  **D** X 2  **J** X 2

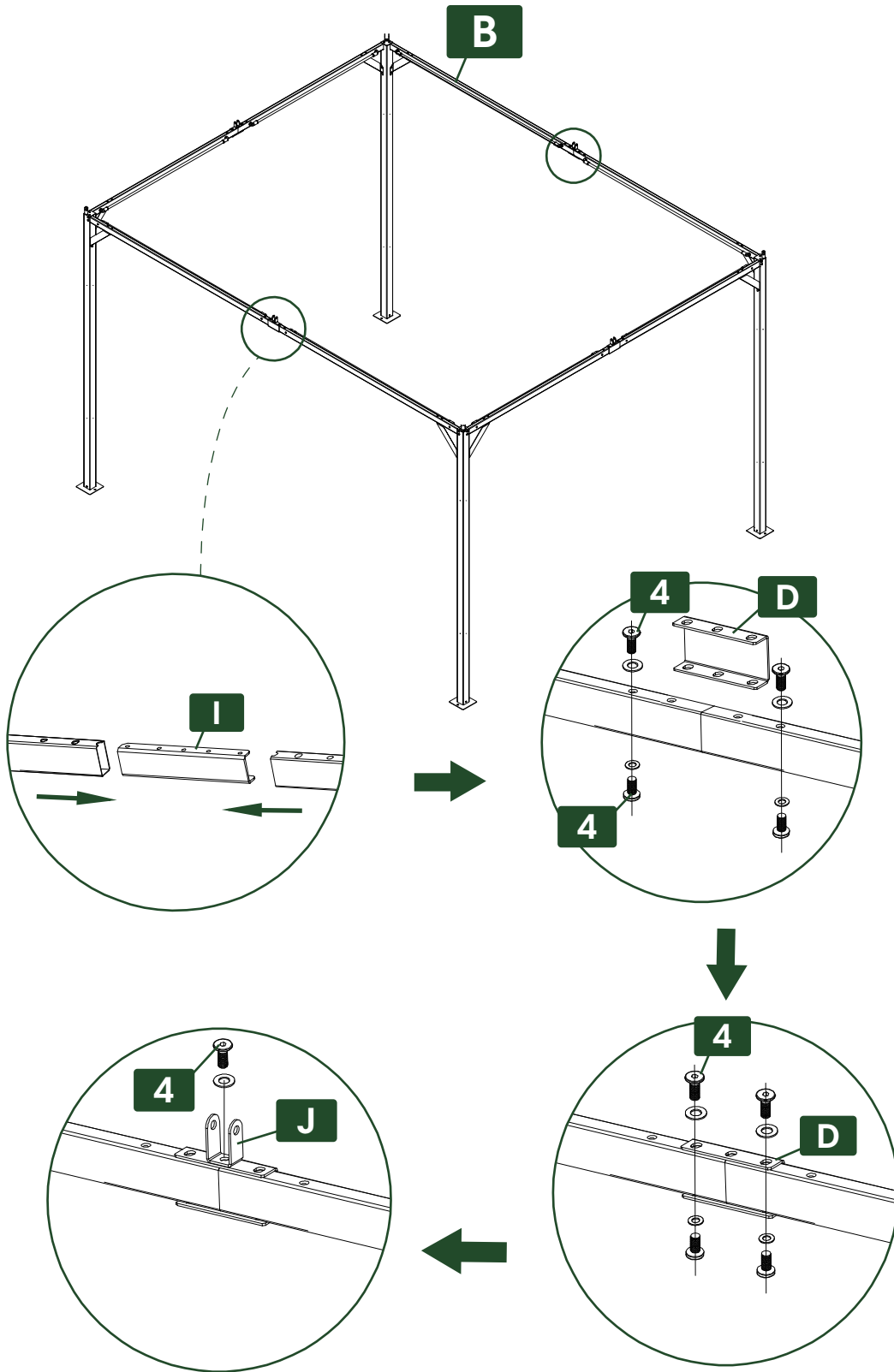

 Check if the frames are aligned.
You can use a level gauge for this.

 **4** X 18

Phase 2: Top Frame

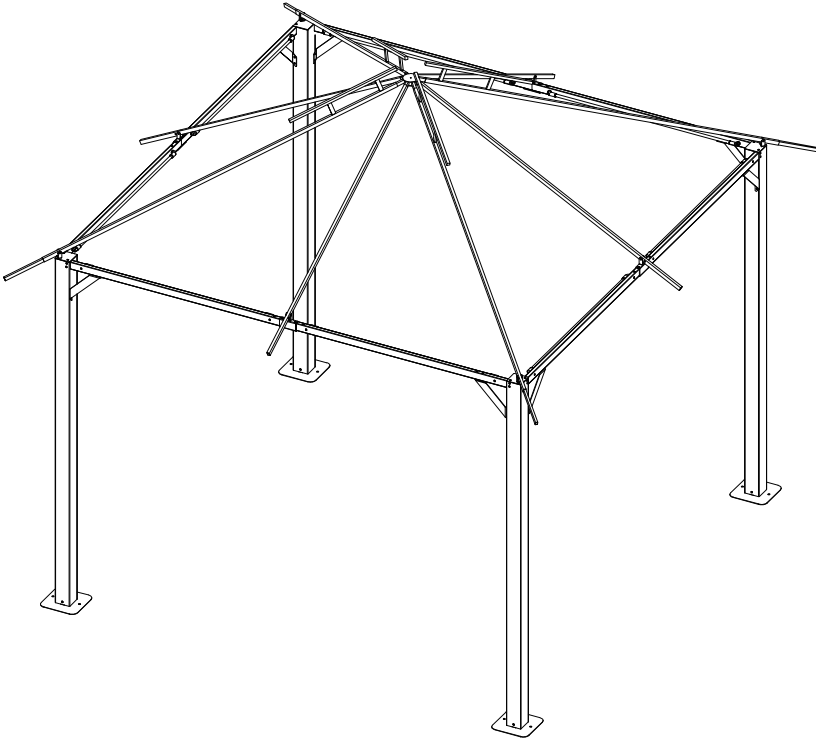

08
STEP

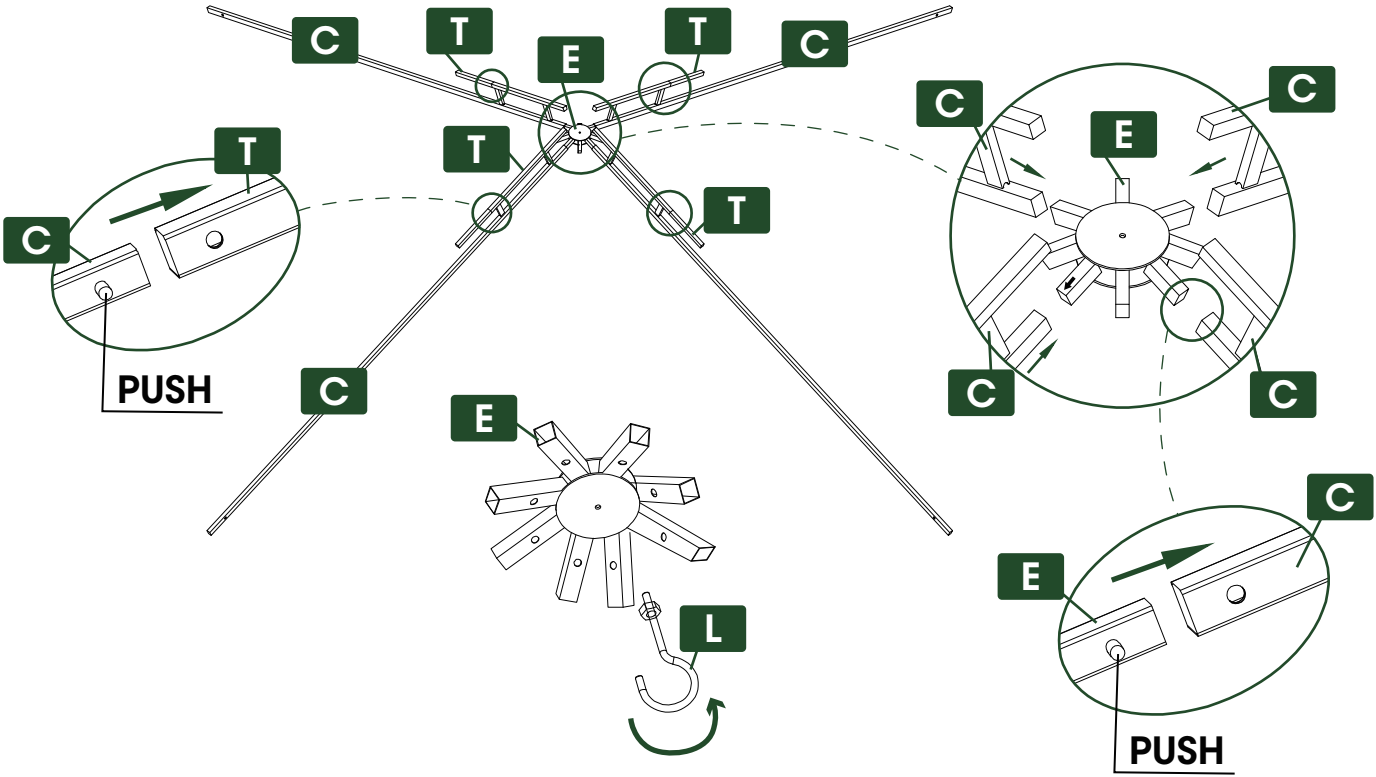

09
STEP

 **C1** X 4

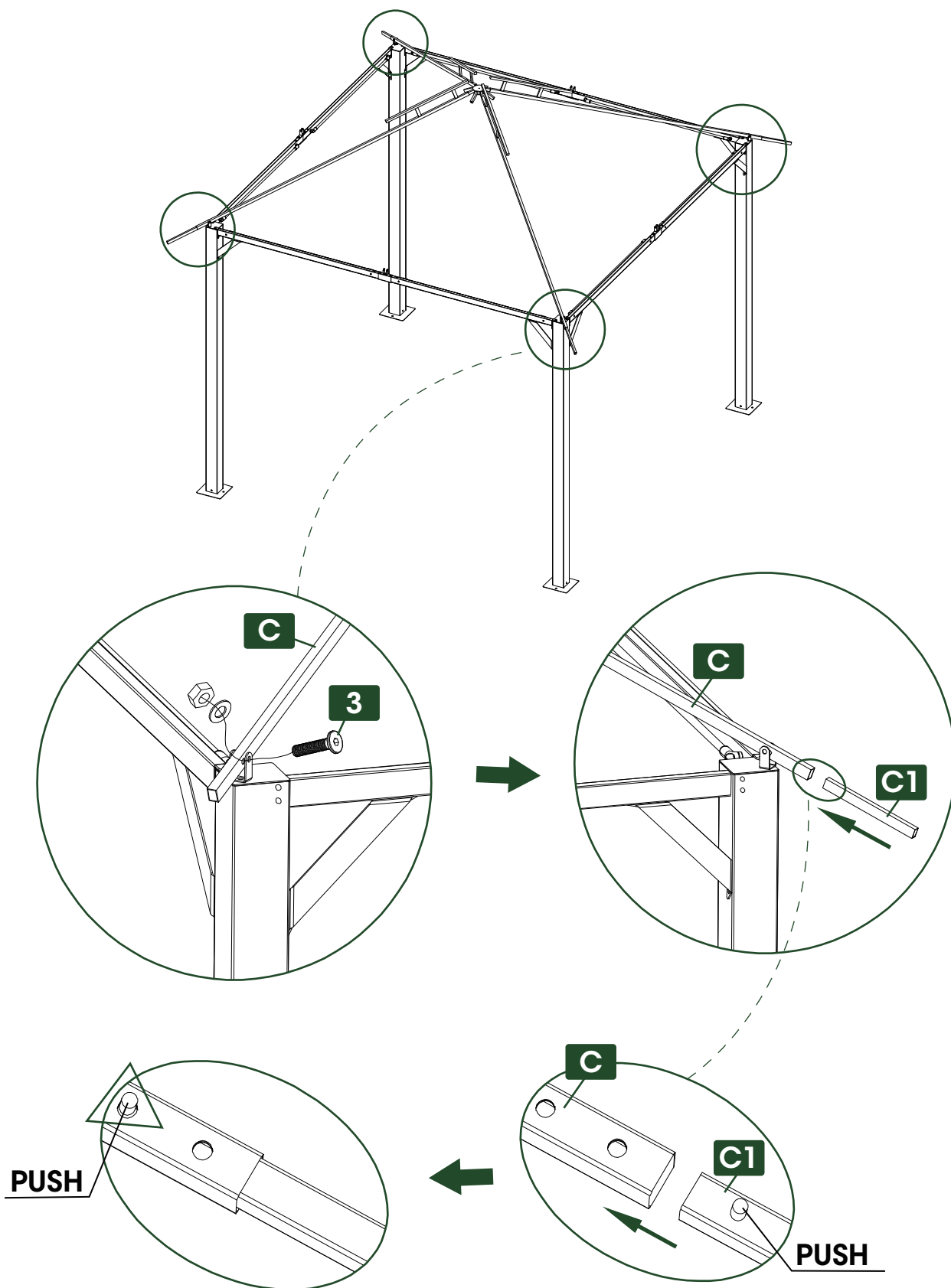

Assemble into the inner hole.

 **3** X 4

10
STEP

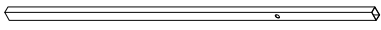

C2 X 4

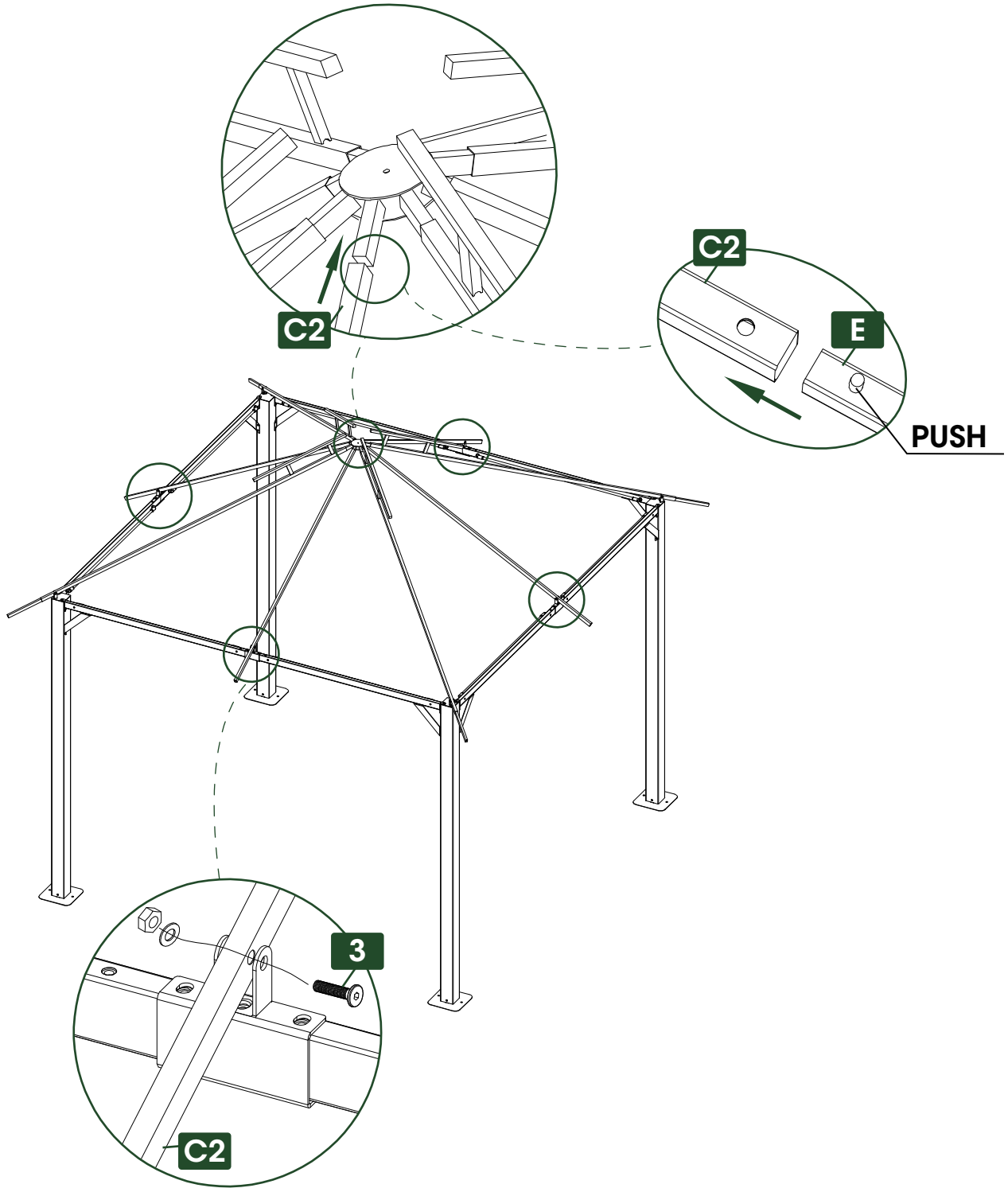

Check if the top frames are aligned. They should be symmetrical on both sides.

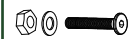

3 X 4

Phase 3: Top Material

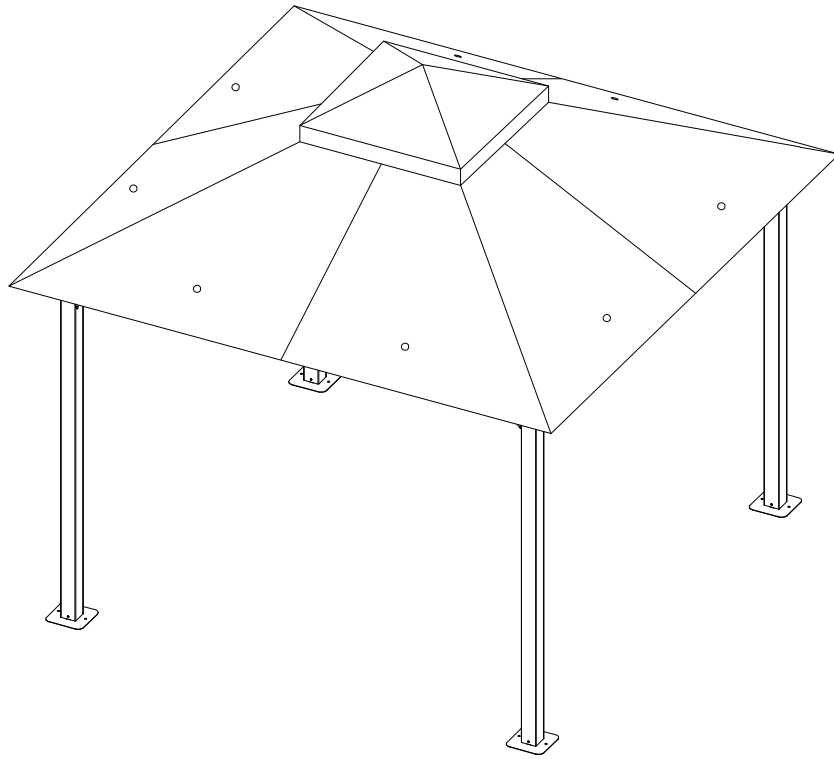

11
STEP

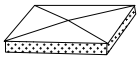

P X 1

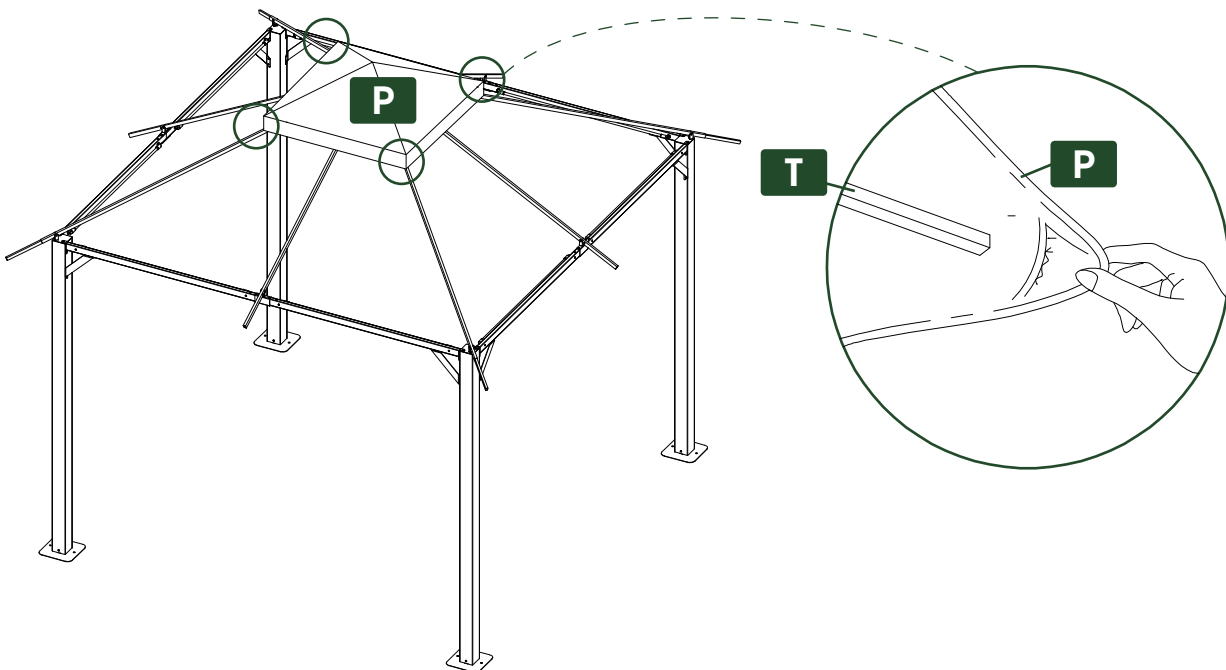

12
STEP

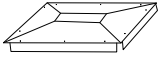

Q x 1

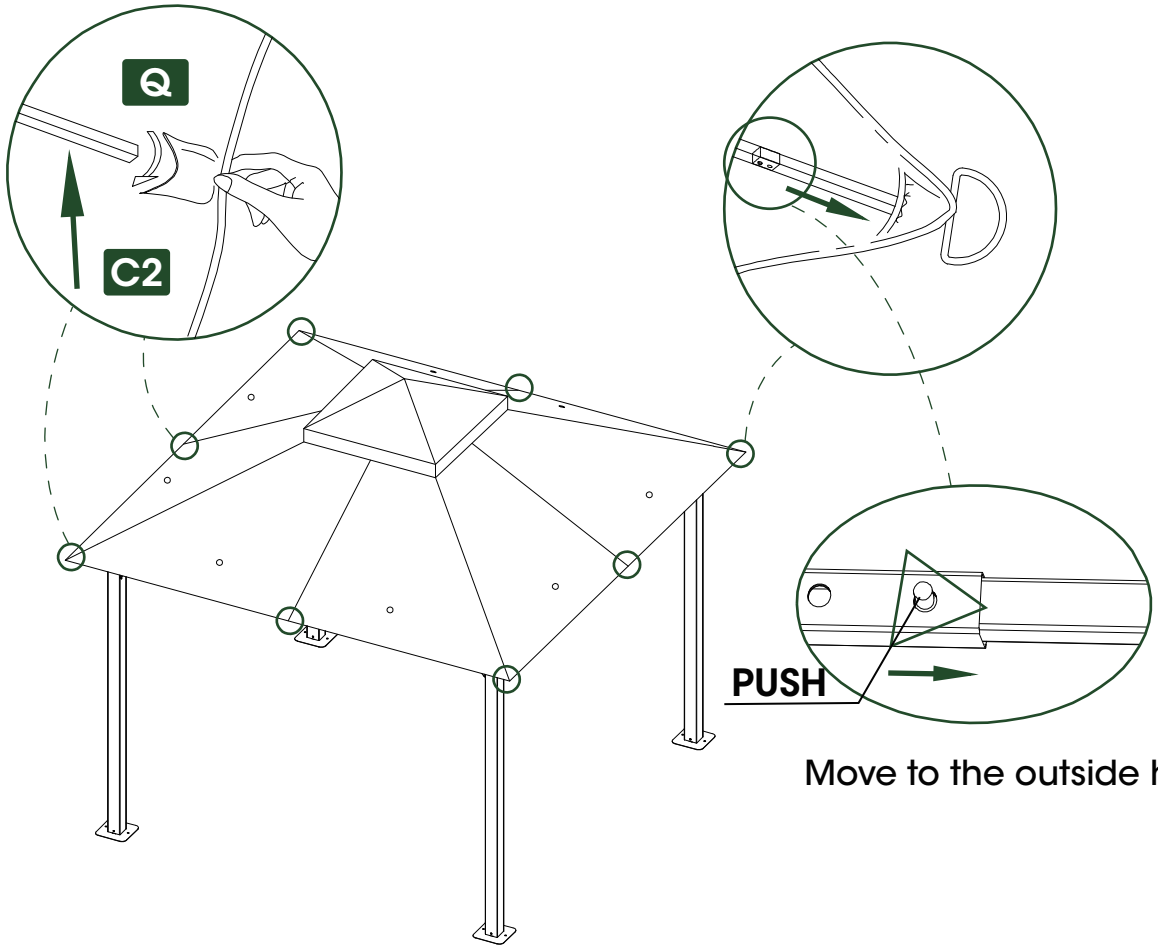

13
STEP

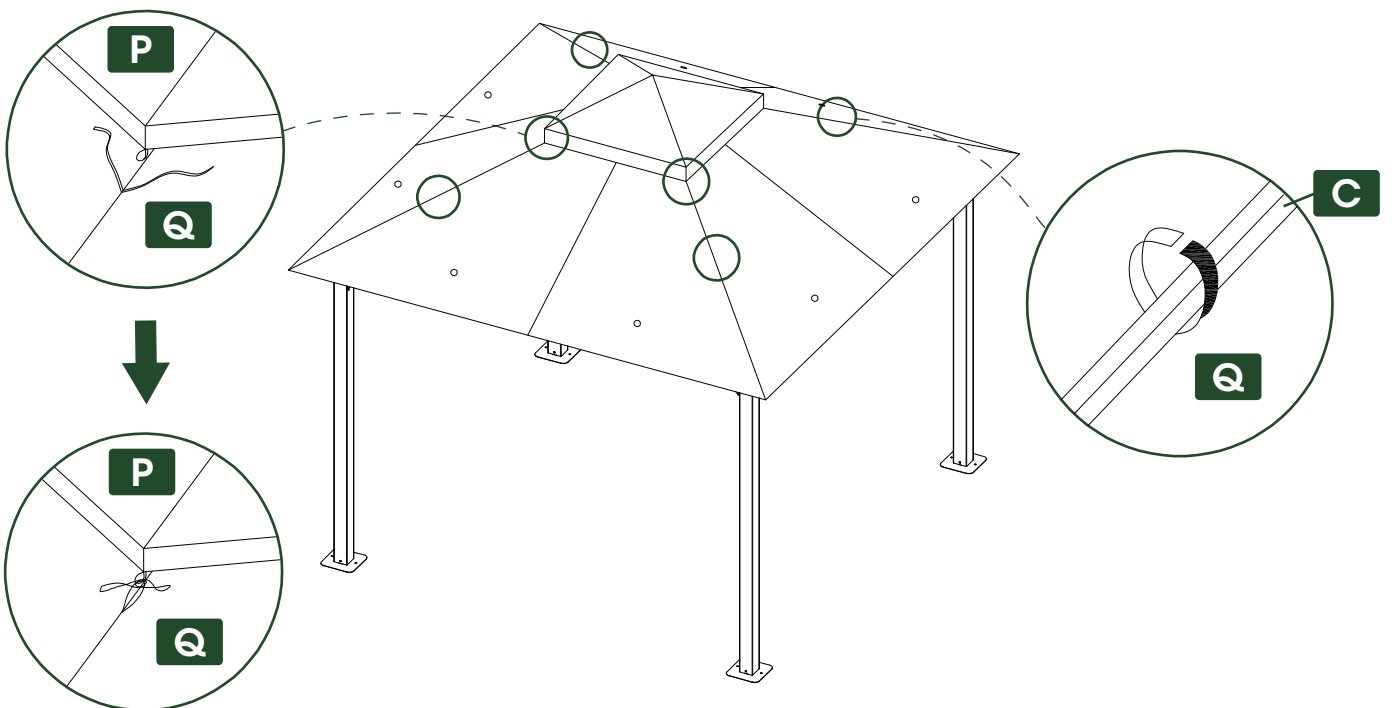

Phase 4: Wall&Curtain&Netting

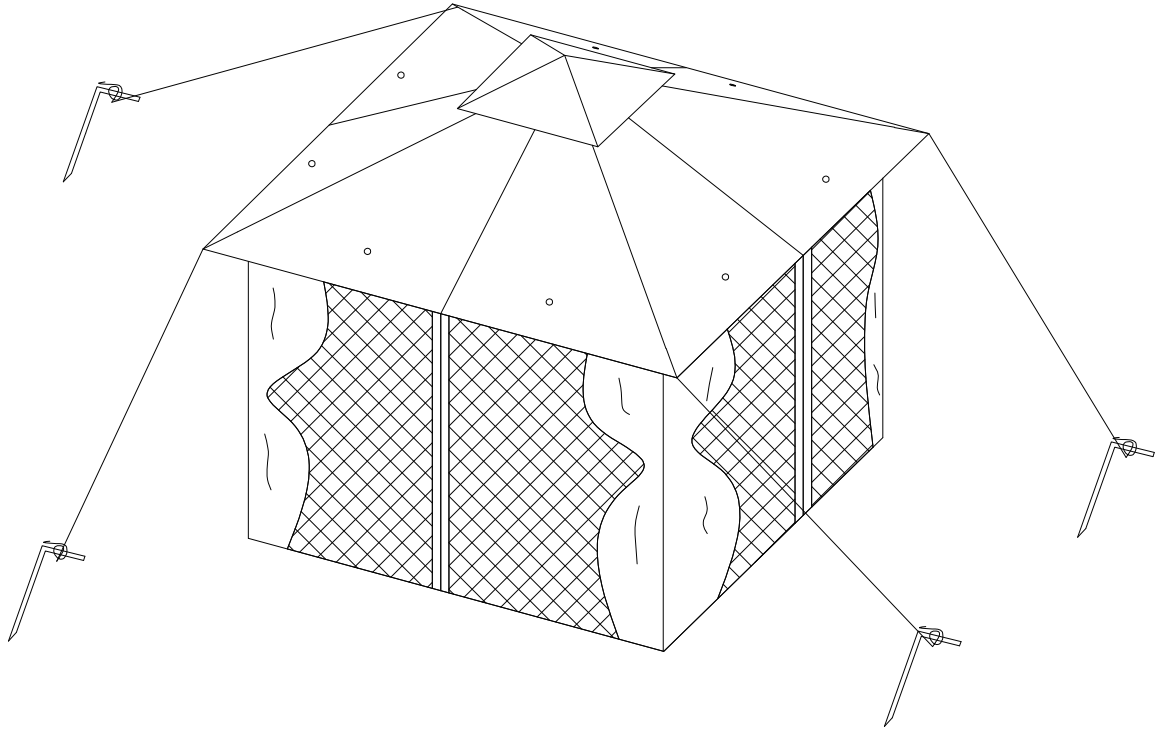

14
STEP

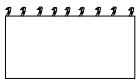

S X 1 (4pcs)

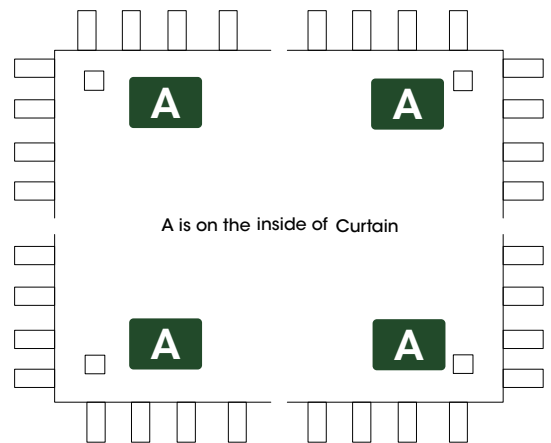
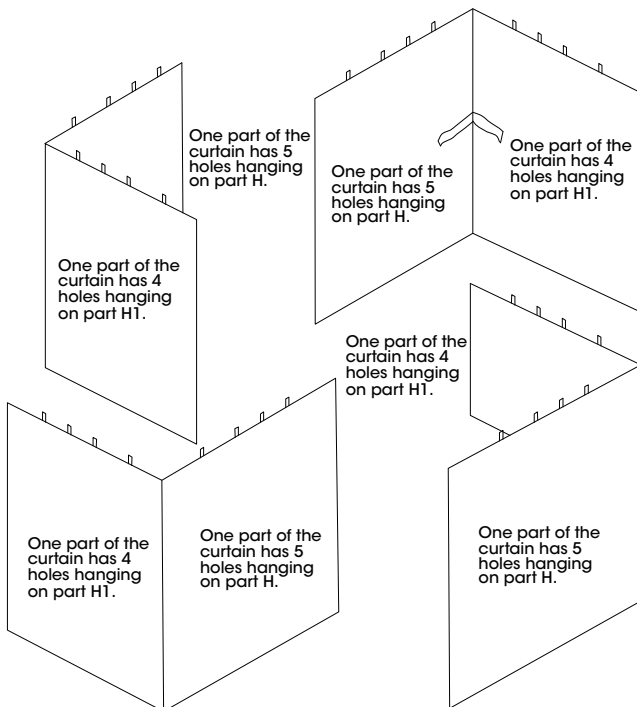

15 STEP

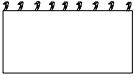

S X 1 (4pcs)

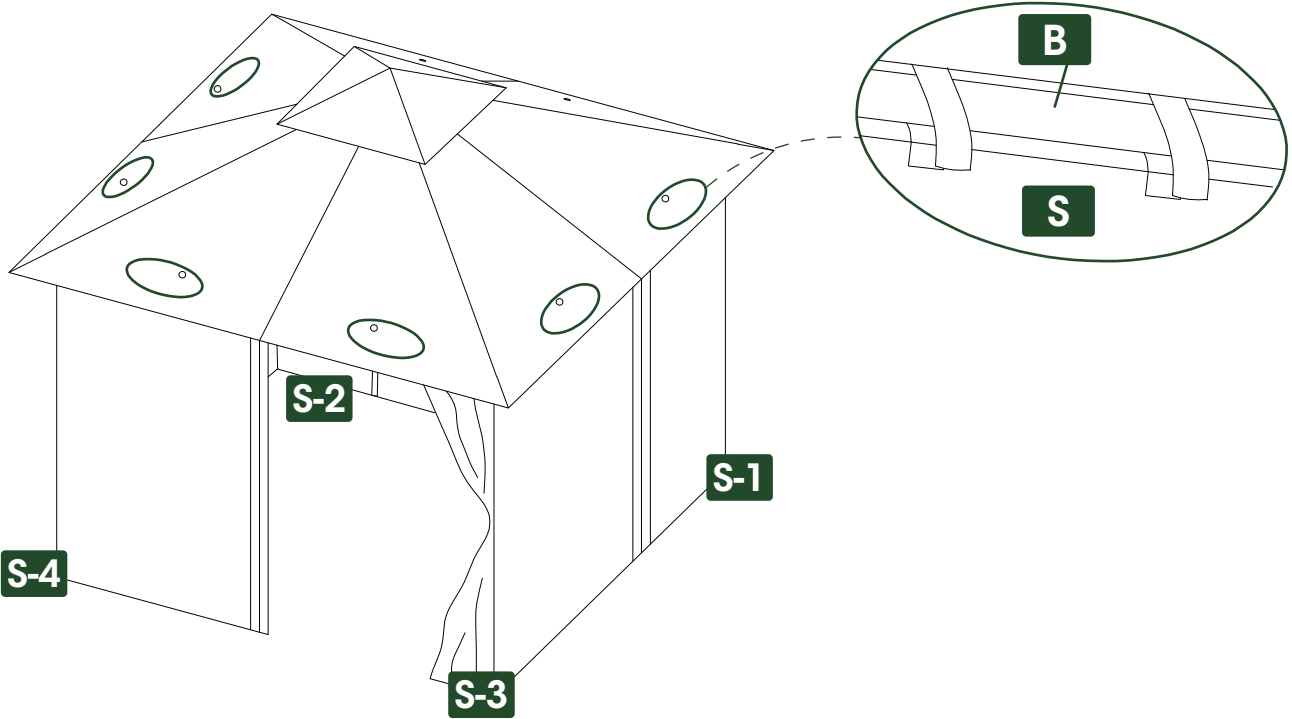

16 STEP

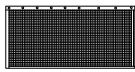

R X 1 (4pcs)

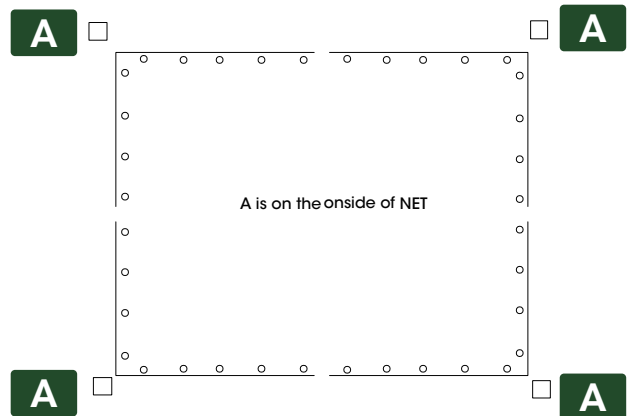
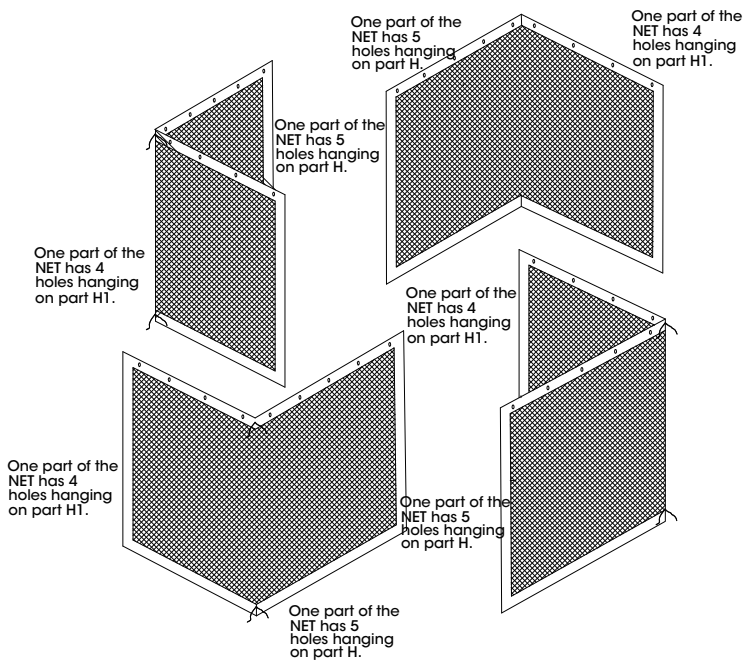

17 STEP



M X 32

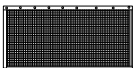

R X 1(4pcs)

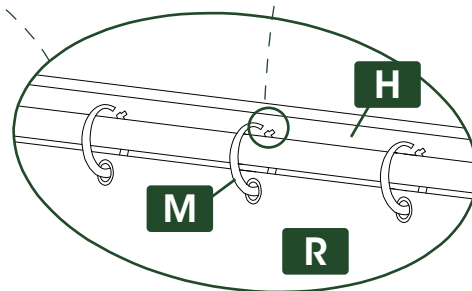
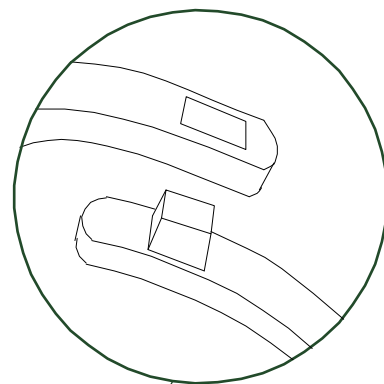
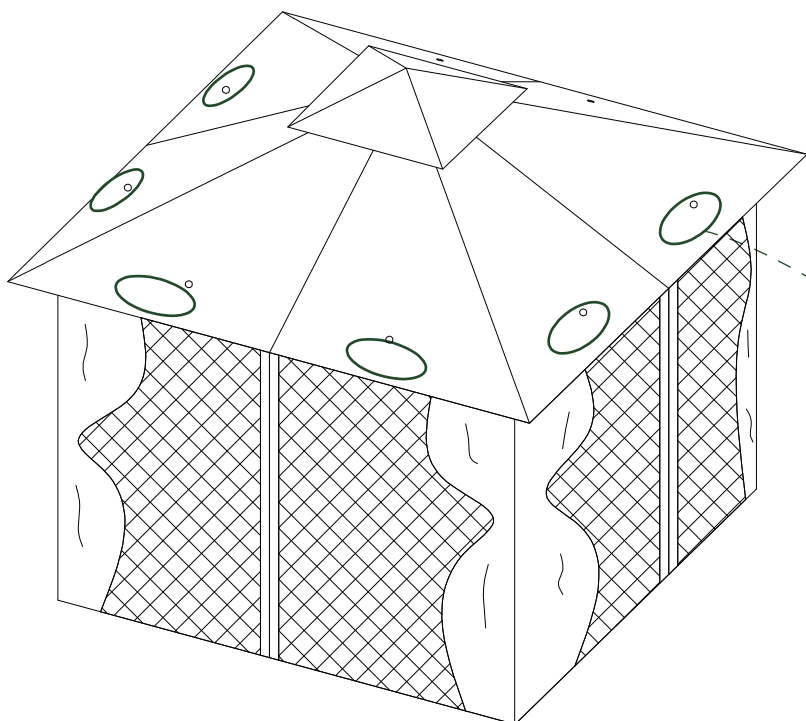

18 STEP

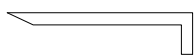

5 X 8

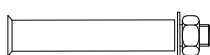

8 X 8

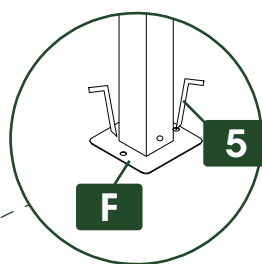
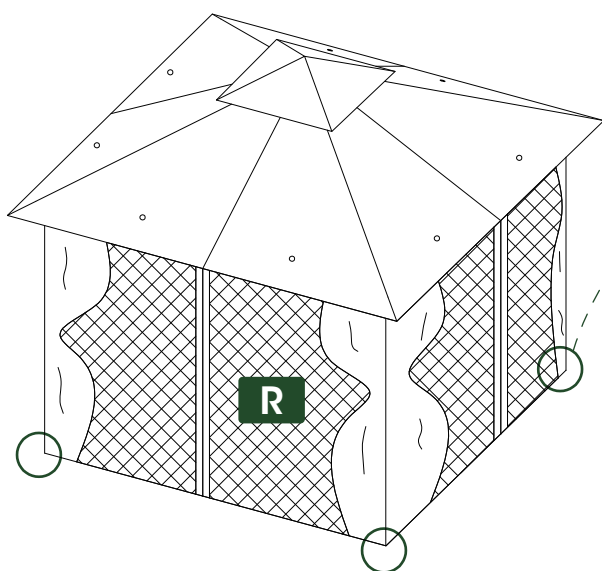

Soft foundation

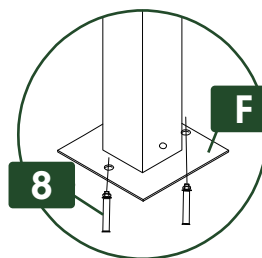

Hard foundation



To improve wind resistance, be sure to complete this installation step. If expansion screws or ground nails are not installed, strong winds may topple the gazebo. Expansion screws are essential for stability on cement surfaces, and ground nails are for grassy surfaces. All are included in the accessories package.

19
STEP

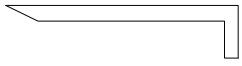

6 X 4



7 X 4

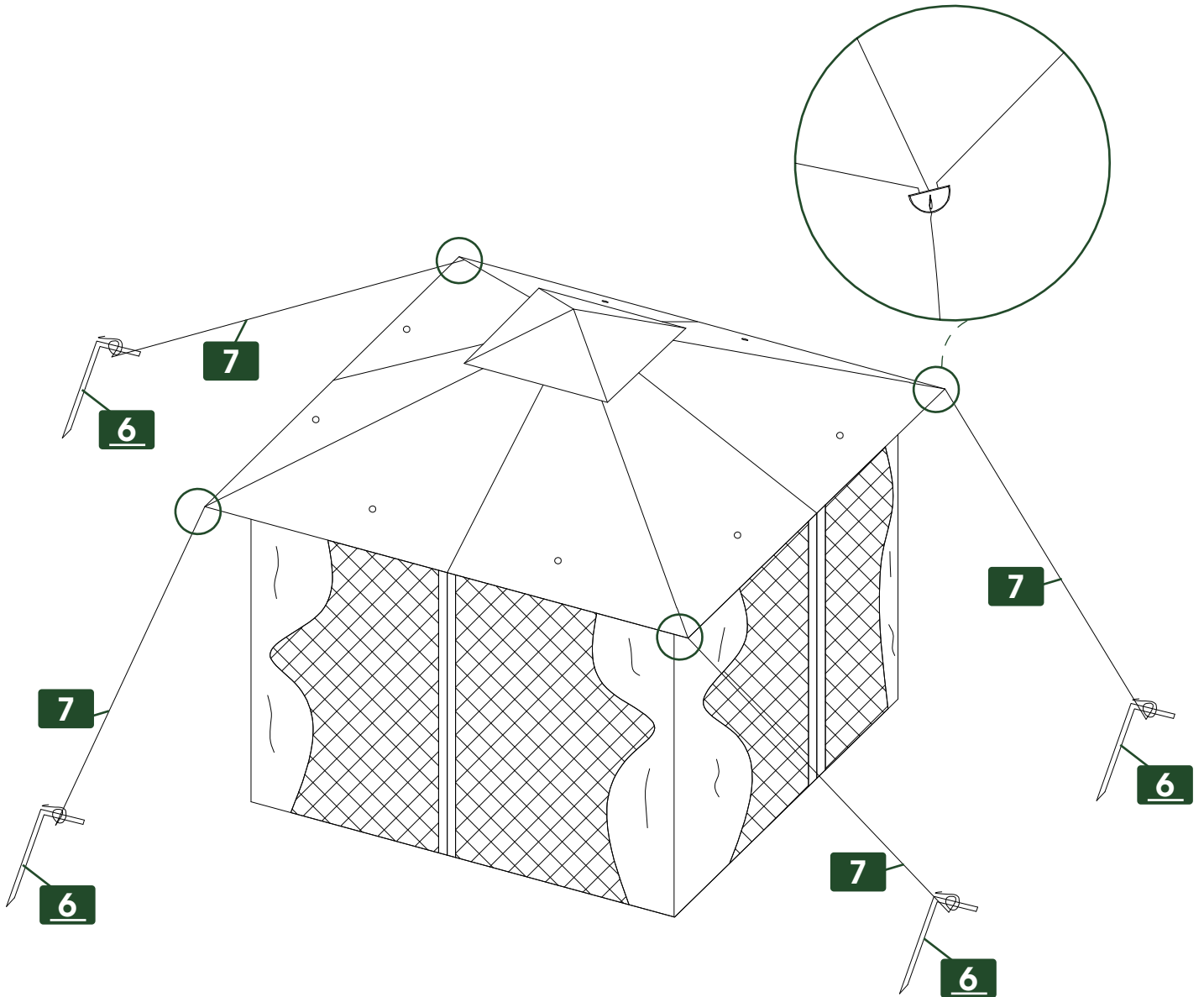

This installation step can further enhance wind resistance when used on grass. Use ropes to connect the D-shaped rings and reinforced ground nails at the four corners of the gazebo, straighten the ropes and insert the reinforced ground nails into the grass. Ropes and reinforced ground nails are included in the accessory pack.

AFTER-SALE

AFTER-SALE SERVICE

If you have any suggestions or encounter quality issues with our products, please contact us first.

Our after-sales team will respond within 24 hours, and we will do our best to provide a solution until you are satisfied.

GUARANTEED CUSTOMER SERVICE

Your shopping experience is very important to us!

If you feel unsatisfied or have any questions,
just contact us!

If you want to share how wonderful our smart product makes your home, **just contact us** and share your pictures!

For further information,
just contact us!



 service@kmcglobe-us.com

 (USA) +1 213-816-4788