

GAZEBO

Assembly Instruction - Please keep properly for future reference.

If you find any missing boxes, damaged parts, or accessory shortages, please contact the customer service team of your purchasing channel immediately. We will resolve the issue as quickly as possible.

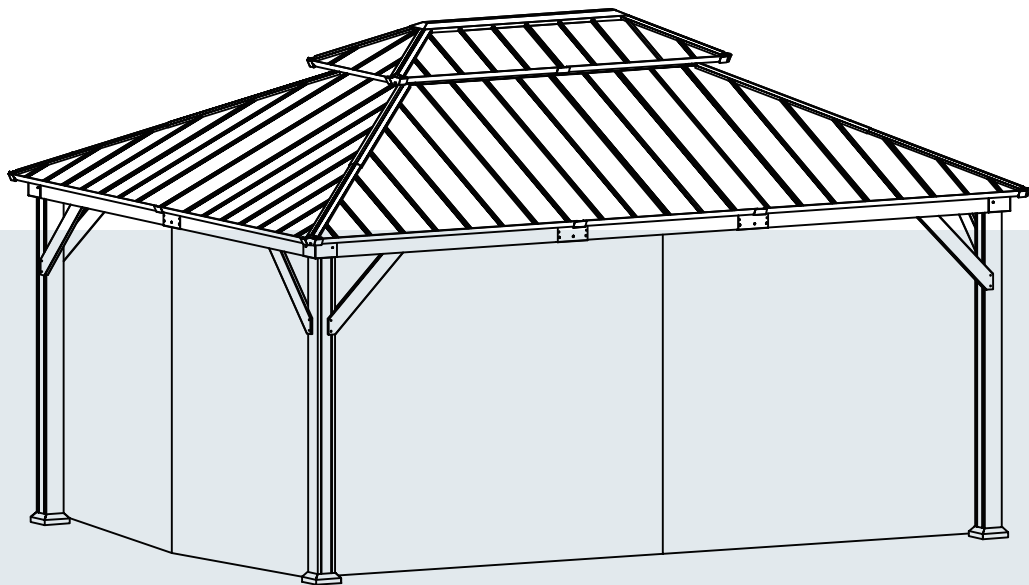

Arrive in 6 separate boxes and may not be part of the same shipment.
Please install the product after receiving all the packages.

CONTACT US

12X16FT

- **Email: service@grandtunnel.com**
In order to receive assistance more quickly, please provide

THE FOLLOWING INFORMATION:

- Order number
- Purchase platform
- Purchase date
- Detailed description of the issue along with photos (if applicable)

EN

Important – Please read these instructions carefully before starting the installation.

BEFORE YOU START

Owner's Manual

Prior to installation, it is important that you contact your local government authority to determine if building approval is required. Study and understand this owner's manual.

Important information and helpful tips will make your construction easier and more enjoyable.

Assembly instructions

Instructions are supplied in this manual and contain all appropriate information for your building model. Review all instructions before you begin. During assembly, follow the step sequence carefully for correct results. Please be aware: **requires four people and take 7-10 hours for installation.**

Parts

Check to be sure that you have all the necessary parts for the building.

Separate contents of the carton by the part number while reviewing parts list.

Familiarize yourself with the hardware and fasteners for easier use during construction. These are packaged within the carton. Note that extra fasteners have been supplied for your convenience.

TOOLS MY REQUIRED

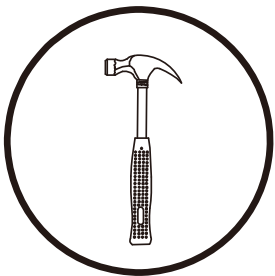

Hammer

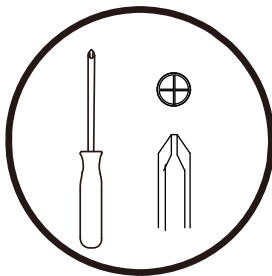

Screwdriver

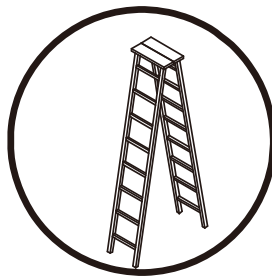

Ladder

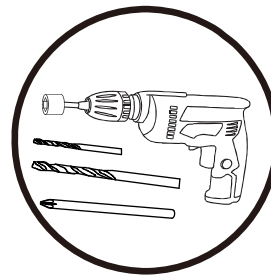

Electric screw driver

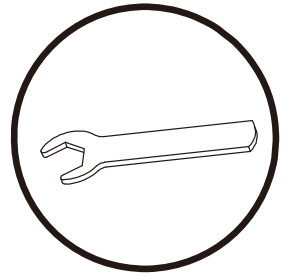

Wrench



This identifies information that requires special attention. Improper assembly could lead to an unsafe or dangerous condition.

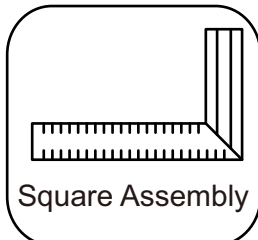

Square Assembly

Check that assembly is square before tightening bolts.

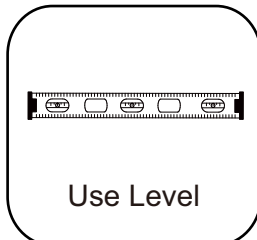

Use Level

Check that set or assembly is properly level before proceeding.

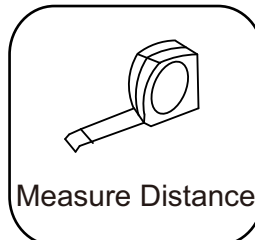

Measure Distance

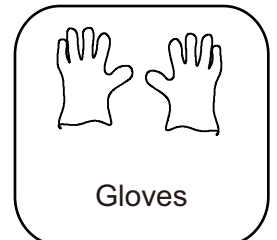

Gloves

IMPORTANT

How many people needed for the installation work
Requires Four people and take 7-10 hours for installation.

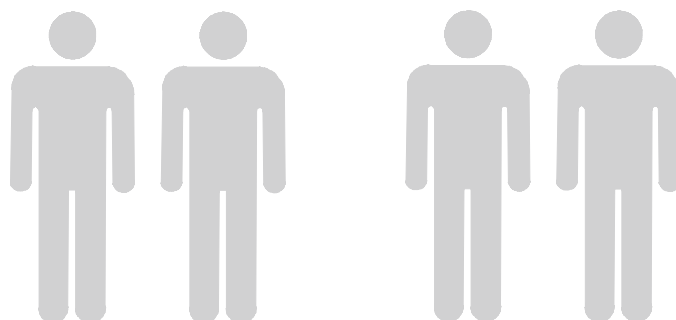

PLAN AHEAD

Site Selection

- Avoid overhanging trees as much as possible, as leaves will make regular cleaning necessary and broken branches are a potential hazard.
- Small trees, bushes or fences nearby can be helpful, acting as a wind break.

Site Preparation

The site must be prepared so that the base of the shed is level all round and checking with a spirit level is required.

The base can be constructed by treated timber or concrete, in order to stop the moisture getting into the shed.

The shed is not designed to be built onto lawn directly. Also the ground will get muddy during rainy days.

If a concrete pad is made, it is important that this slopes towards the edges to prevent water ingress.

Time must be allowed for any concrete or cement to dry before building the shed on top.

Bases can also be constructed from bricks, blocks, or mounted on a concrete pad.

The bricks or blocks should be cemented onto firm and level concrete footings and the greenhouse frame drilled and screwed to the base.

IMPORTANT NOTES:

Find someone to help you: it is much easier with someone to hold parts, pass tool sect. Also some steps require two people to lift structures together. This is not very heavy work so would suit most able-bodied people.

Allow plenty of time: rushing often causes errors and the re-doing of incorrect assemblies. If you have never built a shed before, it can take most of a day to carefully complete the construction.

Have the right tools to hand.

Safety clothing as recommended in the 'Tools' section.

Ideally let out the parts and check that all are present before commencing construction. Lay on cloths or plastic sheets if there is any risk of scratching the parts.

Tighten all nuts carefully, being sure not to miss any. Check the frame is square and using a spirit level to check that it is upright.

For your safety concern, please do not stand under the metal shed in heavy wind or snow days.

For safety, please use expansion screws to reinforce the posts to the ground.

Please clear the snow off the roof in time for the heavy snowfall.

Make sure all screws are tightened before use.

Repeat to confirm all screws, buckles and straps every 90 days.

Please keep all screws loose during the assembly process and tighten them after completing the installation.

Do not use or store objects in the Metal Shed with open flames or flammable chemicals.

Please note that some parts have sharp edges and should be handled with gloves.

If any parts are missing, broken, damaged or worn, discontinue use of the product until repairs are made or factory replacement parts are installed.

Installation of the product in a manner that does not conform to the manufacturer's instructions may result in the loss of the warranty policy for this product.

CUSTOMER SERVICE GUIDE

Thank you for choosing our product! We are committed to providing you with excellent service. If you find any missing parts, damaged packaging, or product damage after receiving all packages, please follow the steps below to quickly contact our customer service team. We will do our best to resolve your issue.

1. Missing Parts

Verify Parts:

1. Refer to the “Parts List” in the manual to verify the name, specifications, and quantity of the missing parts.
2. Take a clear photo of the parts list and mark the missing parts with detailed information, e.g., “Missing 5 pieces of M6x30mm screws.”

Contact Us:

- By Email:

Send an email to service@grandtunnel.com, with the subject line “Missing Parts Issue.” Include the following in the email:

- A description of the missing parts and a photo of the parts list.
- Order details (order number, purchase platform, purchase date).

2. Product or Packaging Damage

If it affects normal use:

Steps:

1. Take clear photos or videos showing the damaged parts and the extent of the damage (multi-angle shots are recommended).
2. Email the photos/videos along with other details to service@grandtunnel.com, with the subject line “Product Damage Issue.”

Resolution:

After verification, we will arrange for a replacement part, product exchange, or refund as quickly as possible.

If it does not affect normal use:

Steps:

1. Contact our customer service team (by email: service@grandtunnel.com).
2. Provide a description of the damage and include relevant photos or videos.

Resolution:

We will provide repair guidance or an appropriate compensation plan based on the specific situation.

Contact Us:

- Customer Service Email: service@grandtunnel.com

Helpful Tips

To process your issue efficiently, please prepare the following information:



- Order details (order number, purchase platform, purchase date).
- Clear photos or videos.
- We are committed to providing quick and professional solutions, no matter the size of the issue, to ensure your satisfaction.

Thank you for your trust and support! We hope you enjoy using our product!





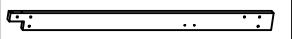
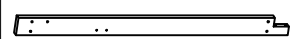
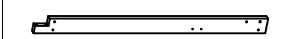
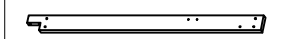
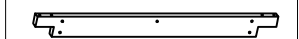

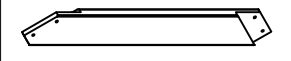
Parts List (Box 1)

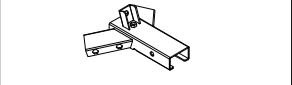

<p>01</p> 				
<p>x4</p>				

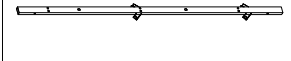
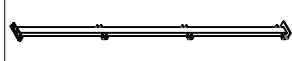
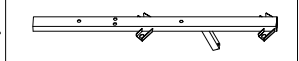
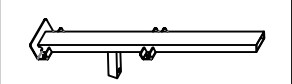
Parts List (Box 2)

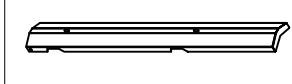





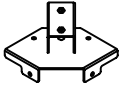
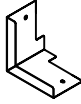



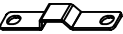
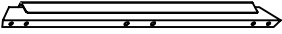

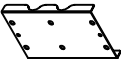

<p>02</p> 	<p>03</p> 	<p>04</p> 	<p>05</p> 	<p>06</p> 
<p>x2</p>	<p>x2</p>	<p>x2</p>	<p>x2</p>	<p>x2</p>
<p>11</p> 	<p>12</p> 			
<p>x4</p>	<p>x4</p>			

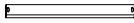
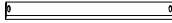
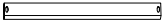
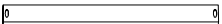
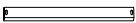

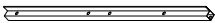

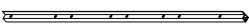
Parts List (Box 3)

<p>D</p> 	<p>D4</p> 	<p>G1</p> 	<p>J1</p> 	<p>K</p> 
<p>x4</p>	<p>x1</p>	<p>x4</p>	<p>x6</p>	<p>x4</p>
<p>K1</p> 	<p>R3</p> 	<p>R4</p> 	<p>R6</p> 	<p>R7</p> 
<p>x2</p>	<p>x1</p>	<p>x4</p>	<p>x2</p>	<p>x2</p>

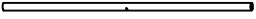

(R5)	(T2)	(T4)	(T8)	
				
x4	x6	x4	x4	

Parts List (Box 4)





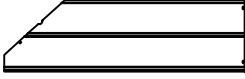

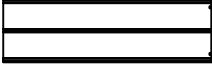
(S)	(D5)	(D6)	(G2)	(Y3)
				
x40	x2	x2	x4	x8
(T3)	(P)	(L1)	(L3)	(L5)
				
x6	x2	x2	x4	x8
(L6)	(L8)	(M1)	(M3)	(M4)
				
x8	x4	x2	x2	x2
(M7)	(M8)	(M10)	(Z1)	(Z2)
				
x4	x4	x2	x4	x12

<p>(Z3)</p> 	<p>(B)</p> 	<p>(C)</p> 	<p>(Z4)</p> 	<p>(Z5)</p> 
<p>x4</p>	<p>x4</p>	<p>x4</p>	<p>x12</p>	<p>x12</p>

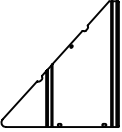
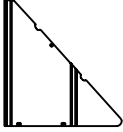
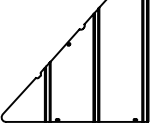
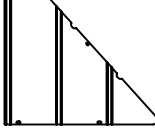

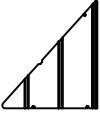
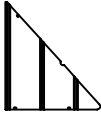

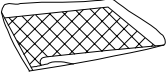







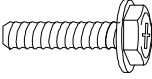

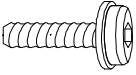
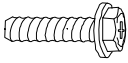
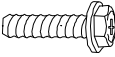

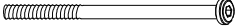

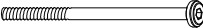
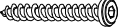

Parts List (Box 5)

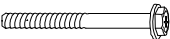
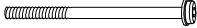
<p>(Q5)</p> 	<p>(Q6)</p> 	<p>(Q7)</p> 	<p>(Q9)</p> 	
<p>x4</p>	<p>x4</p>	<p>x4</p>	<p>x8</p>	

Parts List (Box 6)

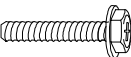
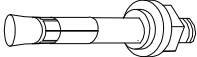
<p>(P1)</p> 	<p>(P2)</p> 	<p>(P4)</p> 	<p>(P5)</p> 	<p>(P6)</p> 
<p>x2</p>	<p>x2</p>	<p>x2</p>	<p>x2</p>	<p>x4</p>
<p>(Q1)</p> 	<p>(Q2)</p> 	<p>(Q3)</p> 	<p>(Q4)</p> 	<p>(U4)</p> 
<p>x4</p>	<p>x4</p>	<p>x4</p>	<p>x4</p>	<p>x1</p>
<p>(V4)</p> 				
<p>x1</p>				

Parts List (in Box 6)

<p>(AA)</p>  <p>M4x16</p>	<p>(BB)</p>  <p>M6x20</p>	<p>(CC)</p>  <p>M6x35</p>	<p>(DD)</p>  <p>M6</p>	<p>(EE)</p>  <p>M6x30</p>
<p>×8+2</p>	<p>×48+3</p>	<p>×16+1</p>	<p>×4+1</p>	<p>×24+2</p>
<p>(FF)</p>  <p>M6x20</p>	<p>(GG)</p>  <p>M6x15</p>	<p>(HH)</p> 	<p>(H3)</p>  <p>M6x105</p>	<p>(H4)</p>  <p>M5x25</p>
<p>×18+1</p>	<p>×256+12</p>	<p>×128+8</p>	<p>×12+1</p>	<p>×32+3</p>
<p>(H5)</p>  <p>M6</p>	<p>(H6)</p>  <p>M8x70</p>	<p>(H7)</p>  <p>M8x170</p>	<p>(H8)</p>  <p>M6x30</p>	<p>(H9)</p>  <p>M8</p>
<p>×36+3</p>	<p>×8+1</p>	<p>×8+1</p>	<p>×32+3</p>	<p>×60+4</p>
<p>(JJ)</p>  <p>M6x55</p>	<p>(KK)</p>  <p>M6x120</p>	<p>(K2)</p>  <p>M6x45</p>	<p>(LL)</p>  <p>M8</p>	<p>(PP)</p>  <p>D8X180</p>
<p>×4+1</p>	<p>×12+1</p>	<p>×2</p>	<p>×8+1</p>	<p>×8</p>
<p>(QQ)</p>  <p>M6x40</p>	<p>(UU)</p>  <p>M6X80</p>	<p>(Z1)</p>  <p>Open wrench M6</p>	<p>(Z2)</p>  <p>M6</p>	<p>(Z2)</p>  <p>M8</p>
<p>×20+1</p>	<p>×8</p>	<p>×2</p>	<p>×2</p>	<p>×2</p>
<p>(Z4)</p>  <p>Open wrench M8</p>				
<p>×2</p>				

1

As shown in the picture, first slide the ground nail cover (B) into the bottom of the post (A), then insert the ground nail plate (C) into the bottom of the post (A), and secure it with screw (H4).



01 x4

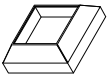

B x4

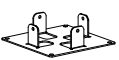

C x4

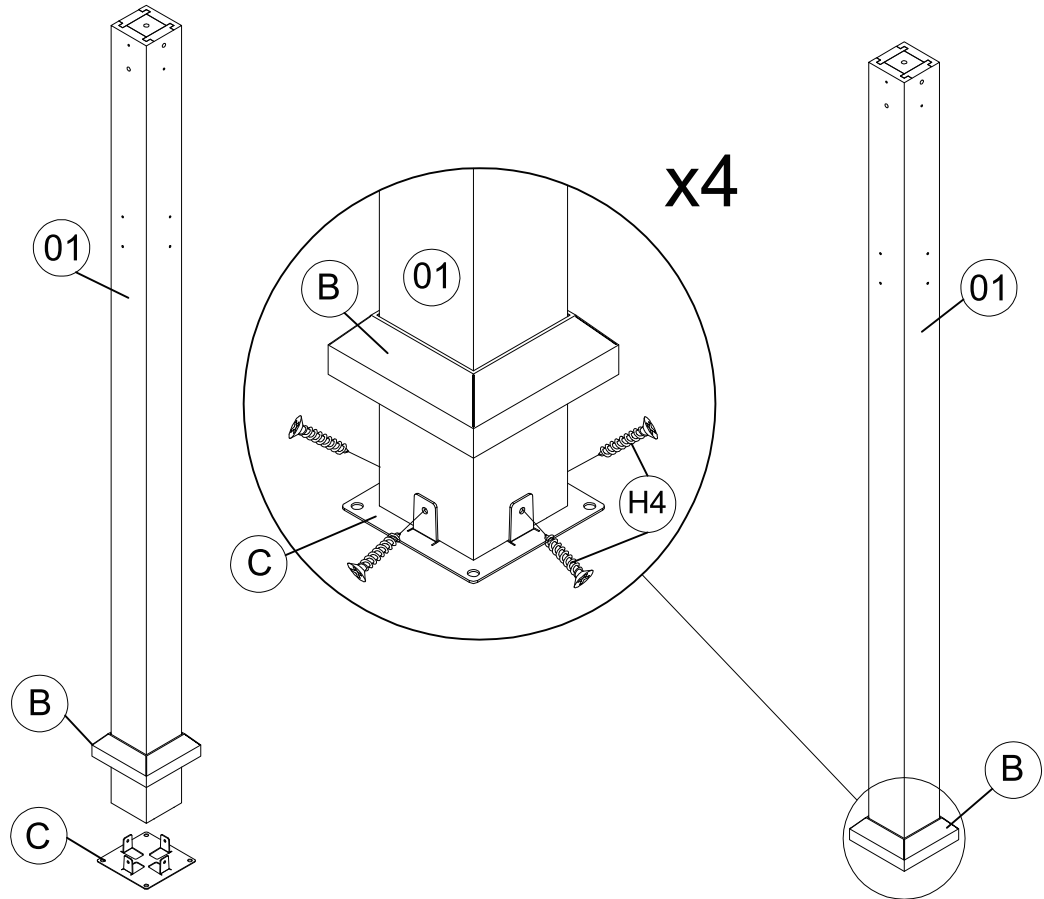

H4 x16



M5x25

2

As shown in the picture, first connect the left short beam (02) and right short beam (03) with screws (H3), barrel nuts (BB), and washers (H9). Then align the beam connector (T2) and beam U-shaped part (T3) with the beam holes, and secure them with screws (EE) and barrel nuts (BB).

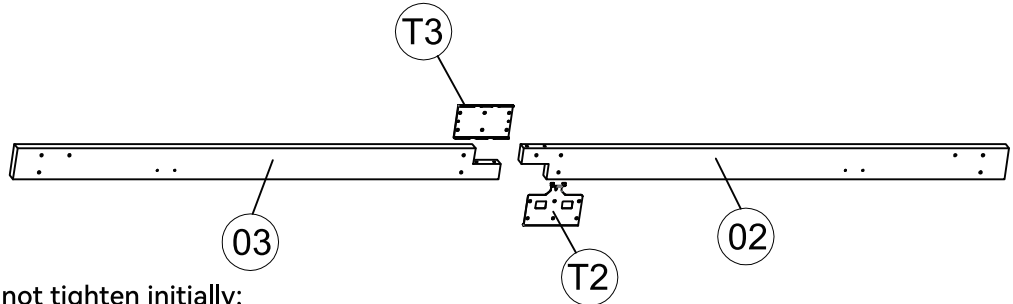
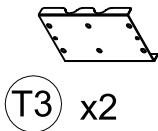
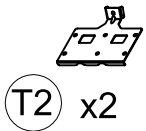
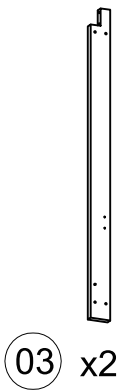
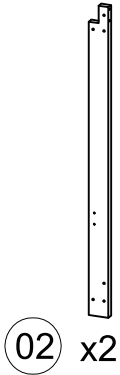



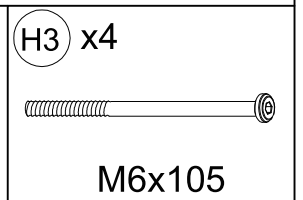
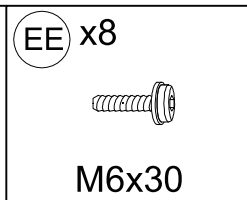
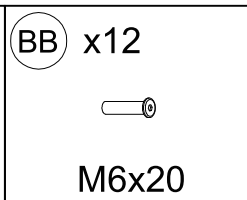
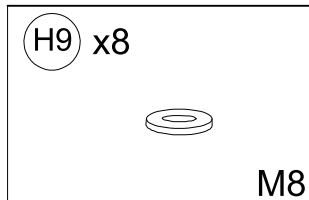
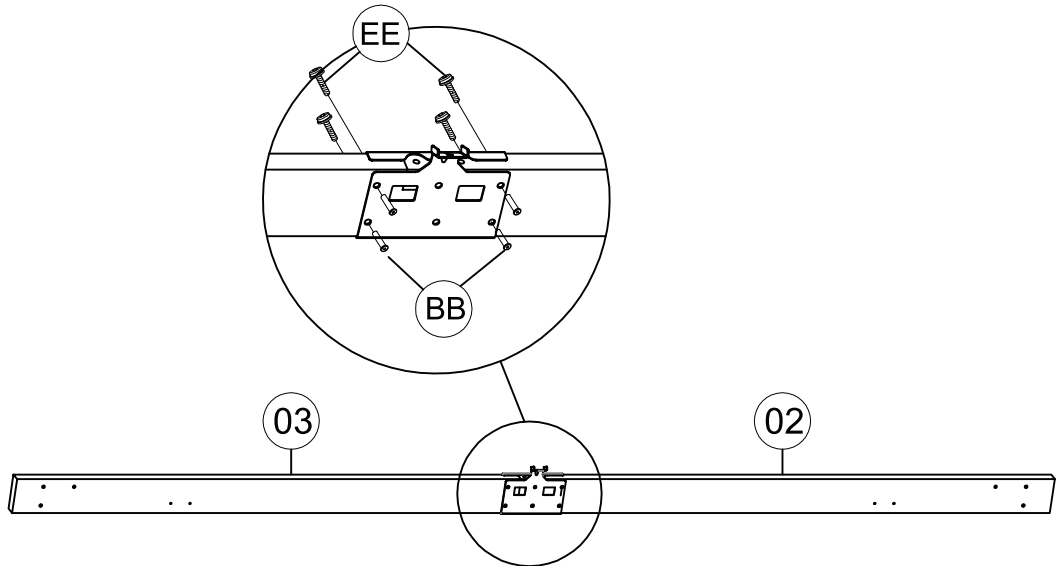
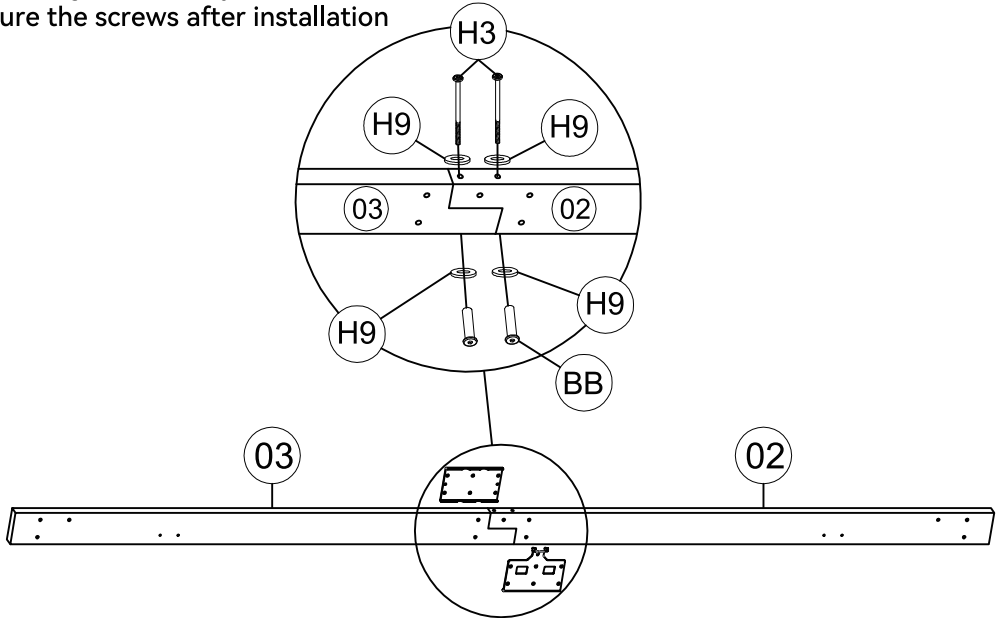

Do not tighten initially;
secure the screws after installation

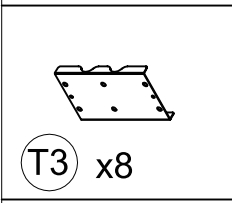
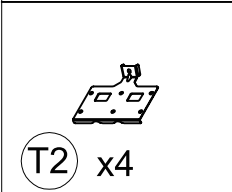
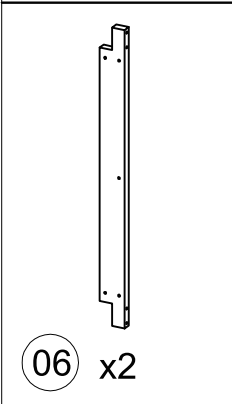
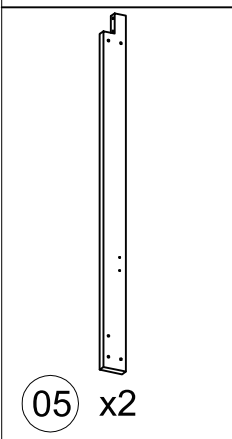
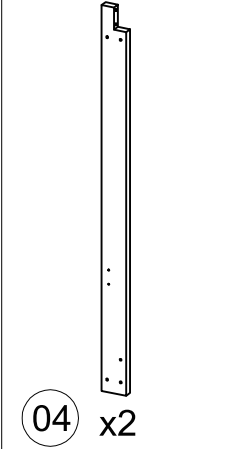
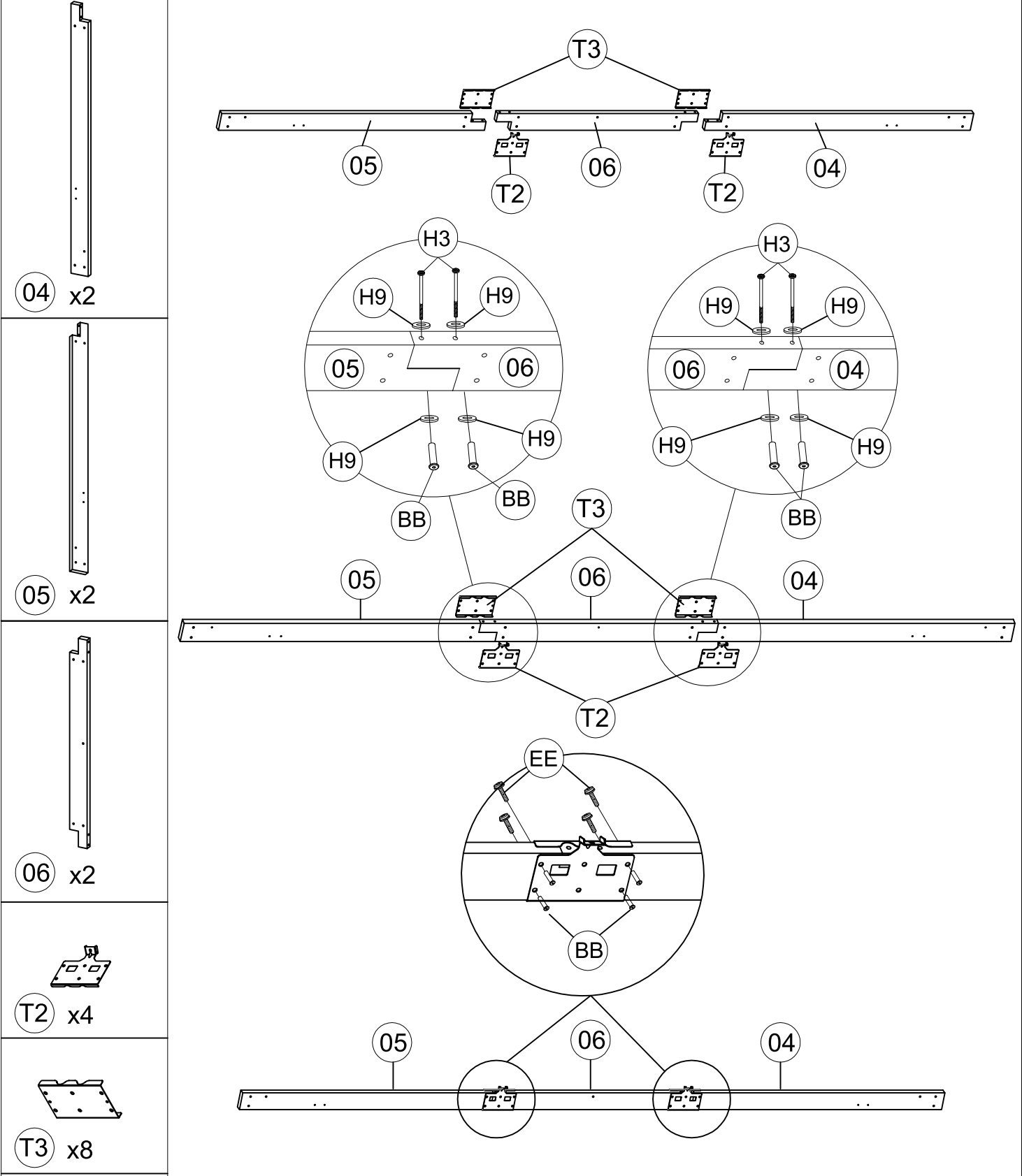

3

As shown in the picture, first connect the left long beam (04), middle long beam (06), and right long beam (05) with screws (H3), barrel nuts (BB), and washers (H9). Then align the beam connector (T2) and beam U-shaped part (T3) with the beam holes, and secure them with screws (EE) and barrel nuts (BB).



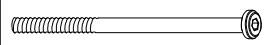

<p>H9 x16</p>  <p>M8</p>	<p>BB x24</p>  <p>M6x20</p>	<p>EE x16</p>  <p>M6x30</p>	<p>H3 x8</p>  <p>M6x105</p>
---	--	--	--

4

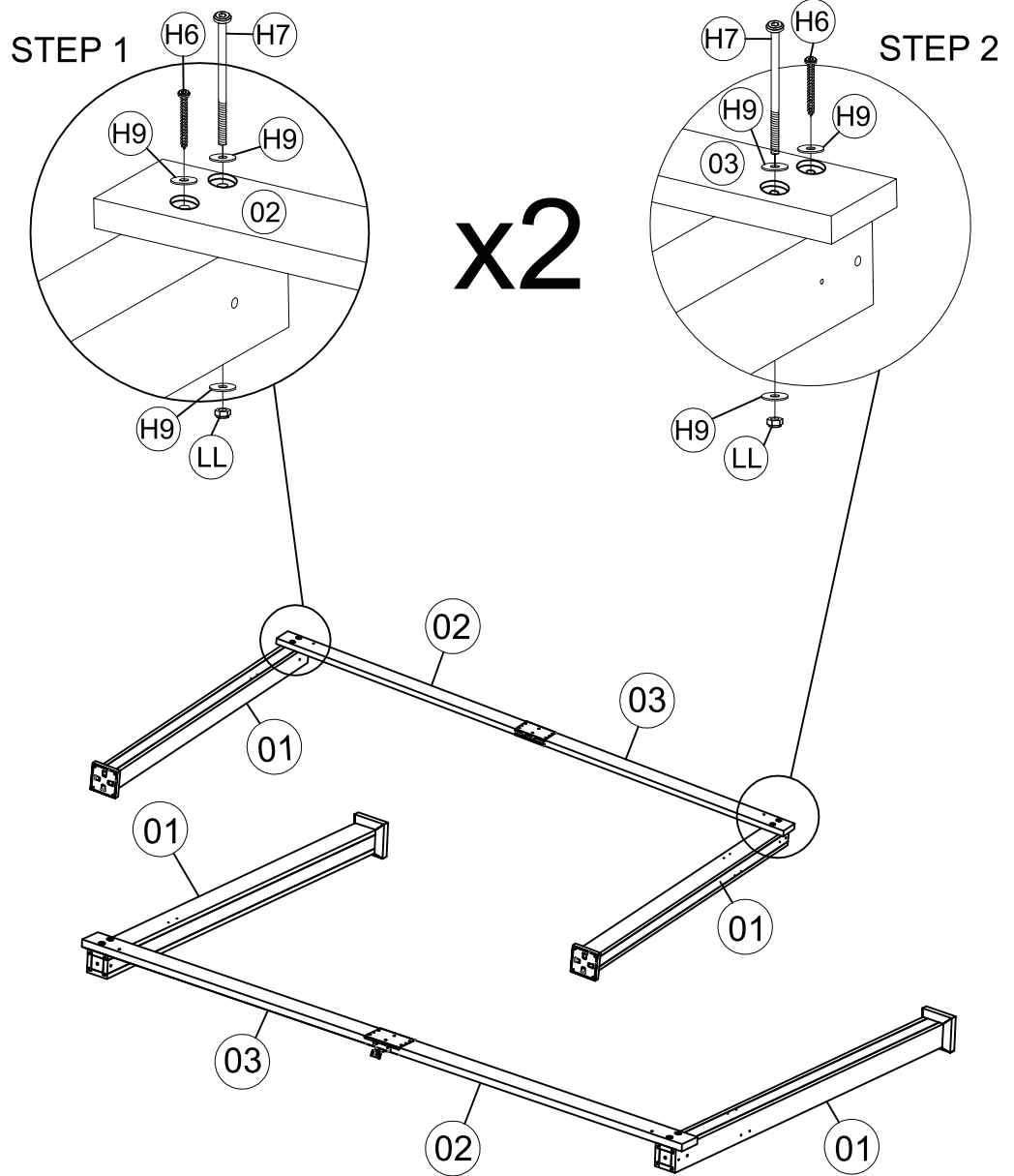
As shown in the picture, place the post (01) flat on the ground and align the assembly from Step 2 with the post holes.
Secure using screws (H7), (H6), washers (H9), and nuts (LL).

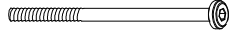

<p>(LL) x4</p>  <p>M8</p>	<p>(H9) x12</p>  <p>M8</p>	<p>(H6) x4</p>  <p>M8x70</p>	<p>(H7) x4</p>  <p>M8x170</p>
--	---	--	--

5

As shown in the picture, align the assembly from Step 3 with the post holes. Secure using screws (H7), (H6), washers (H9), and nuts (LL).

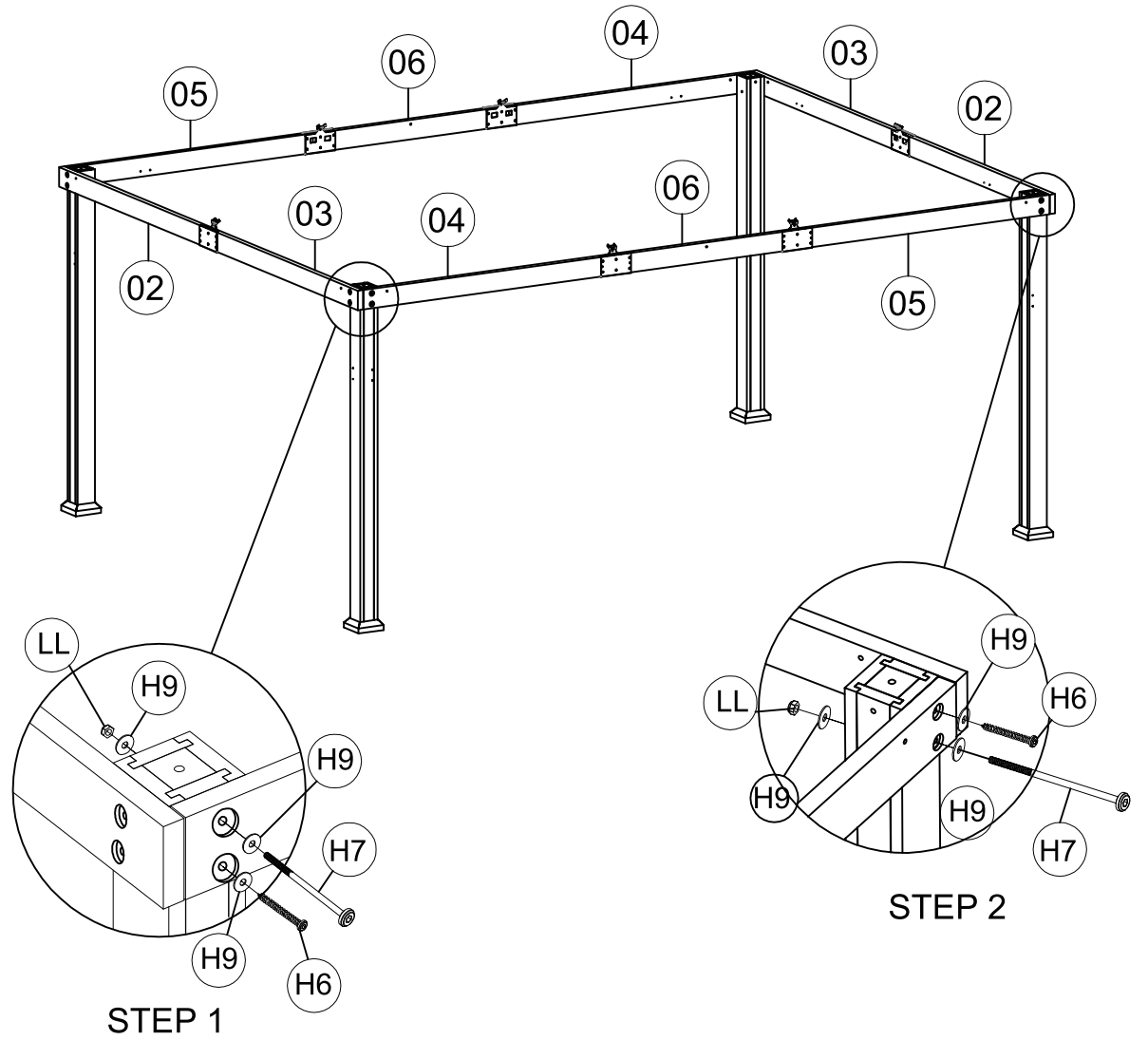

LL x4



M8

H9 x12



M8

H6 x4



M8x70

H7 x4

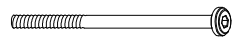

M8x170

6

As shown in the picture, align the diagonal supports (11), (12) with the beam and post holes, and secure with screws (H8) and washers (H5).

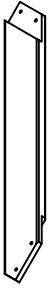

11 x4



12 x4

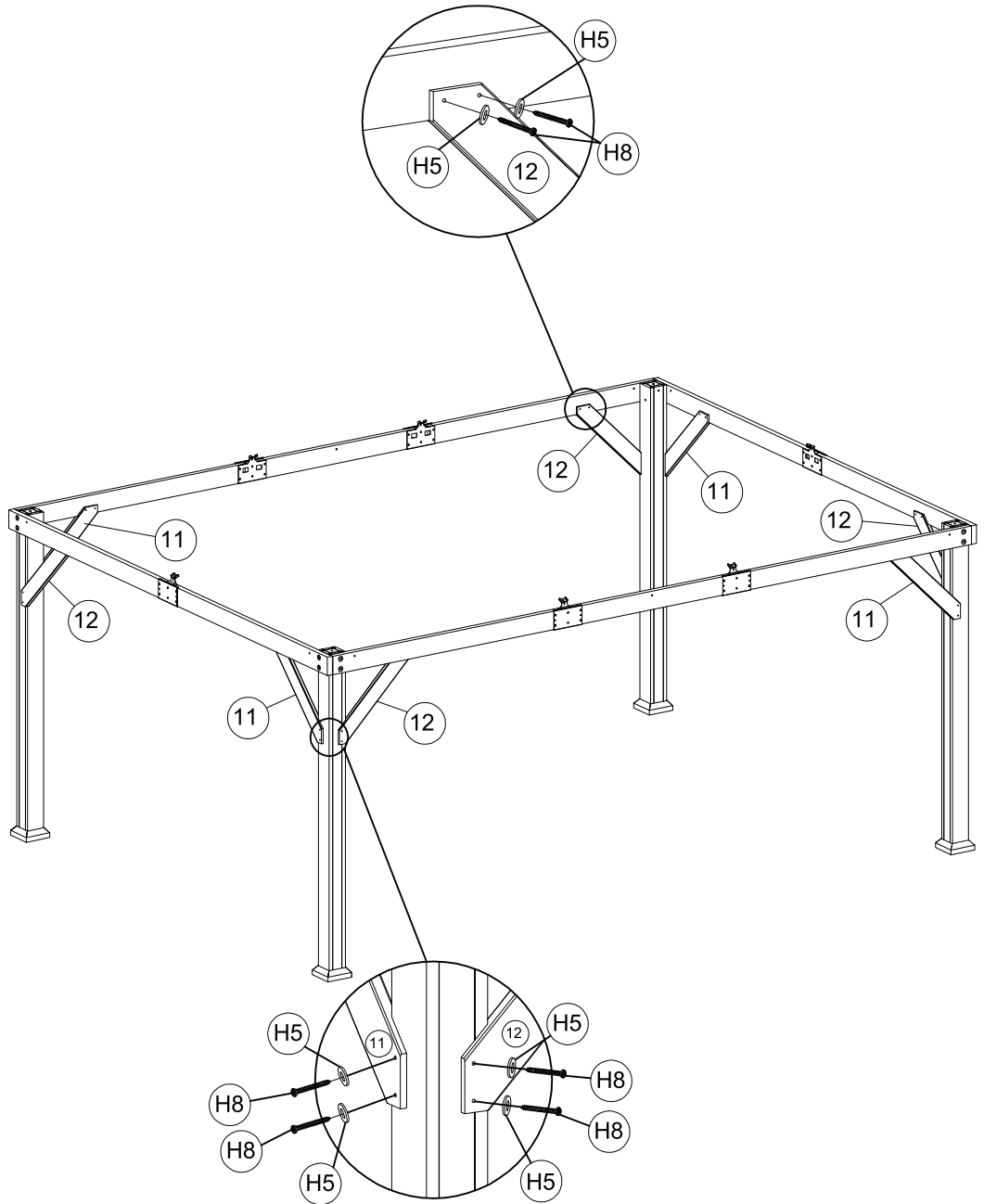
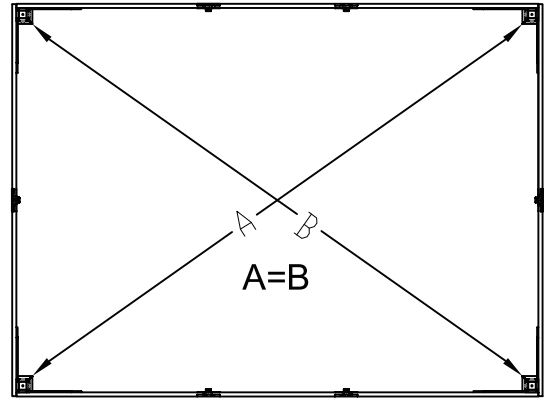

H5 x32



M6

H8 x32



M6x30

7

As shown in the picture, align the lower diagonal beam connector (T4) with the holes on the post and beam, and secure with screw (H4).

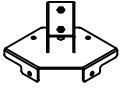

T4 x4

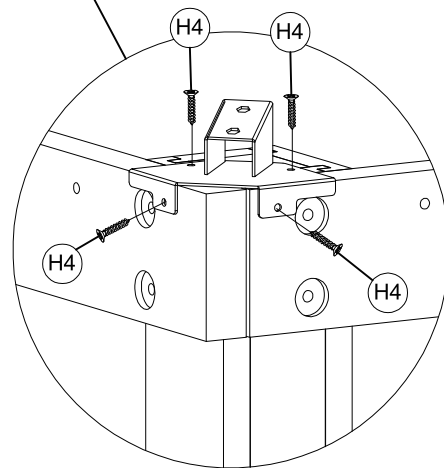
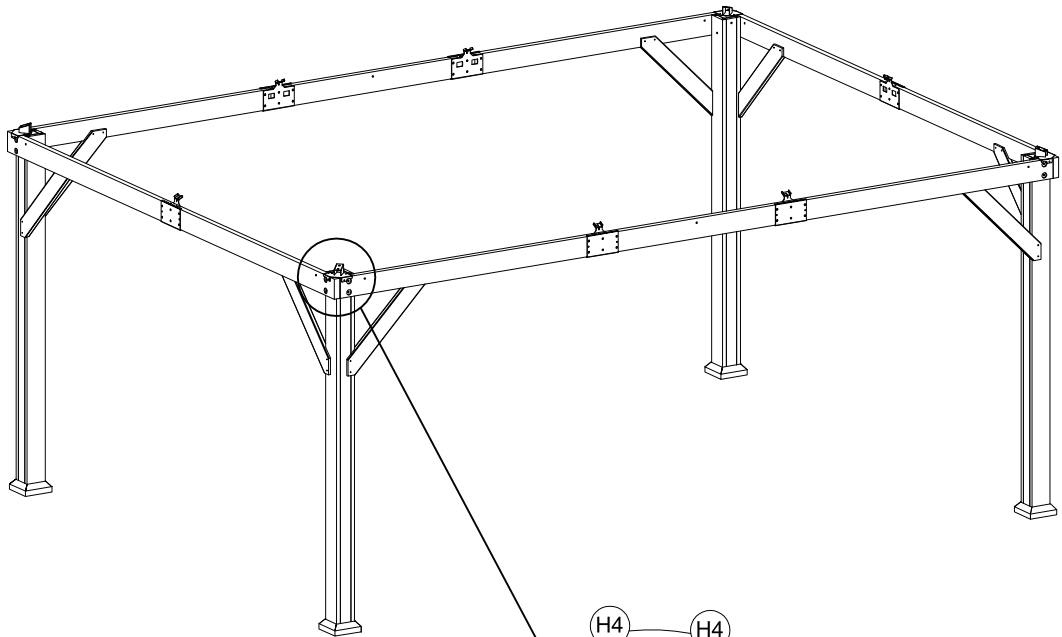

x4

H4 x16



M5x25

8

As shown in the picture, align the beam corner plate (T8) with the beam holes, and secure with screw (AA).



T8 x4

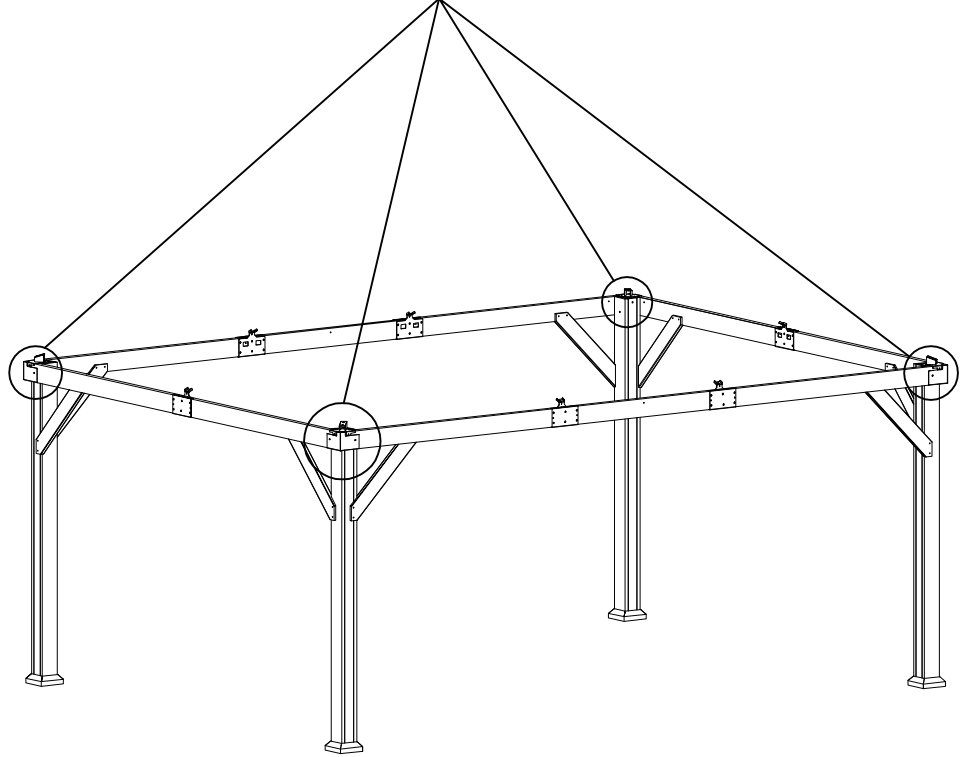
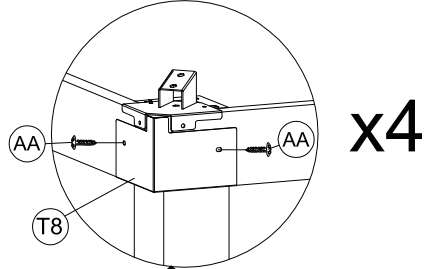

AA x8



M4x16

9

As shown in the picture, connect the mosquito net tubes (Z1) and (Z2) together.

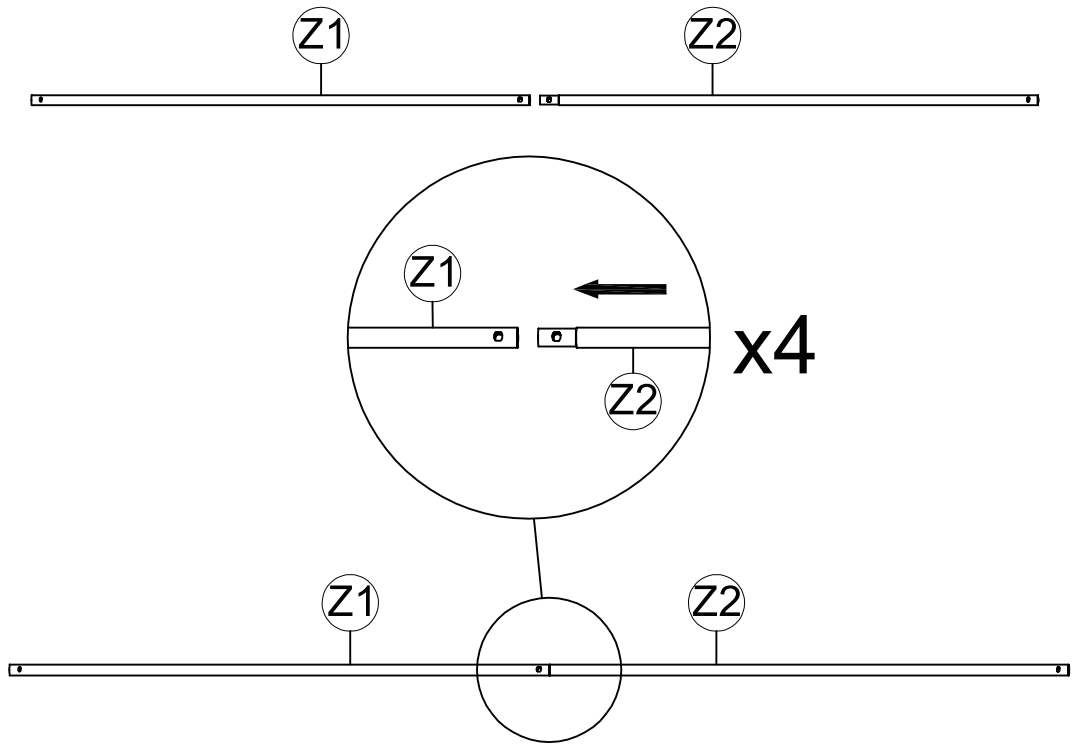
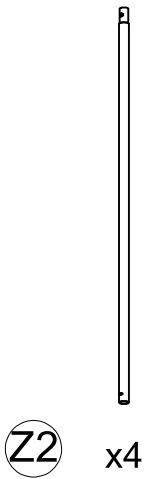

10

As shown in the picture, connect the mosquito net tubes (Z2) and (Z3) together.

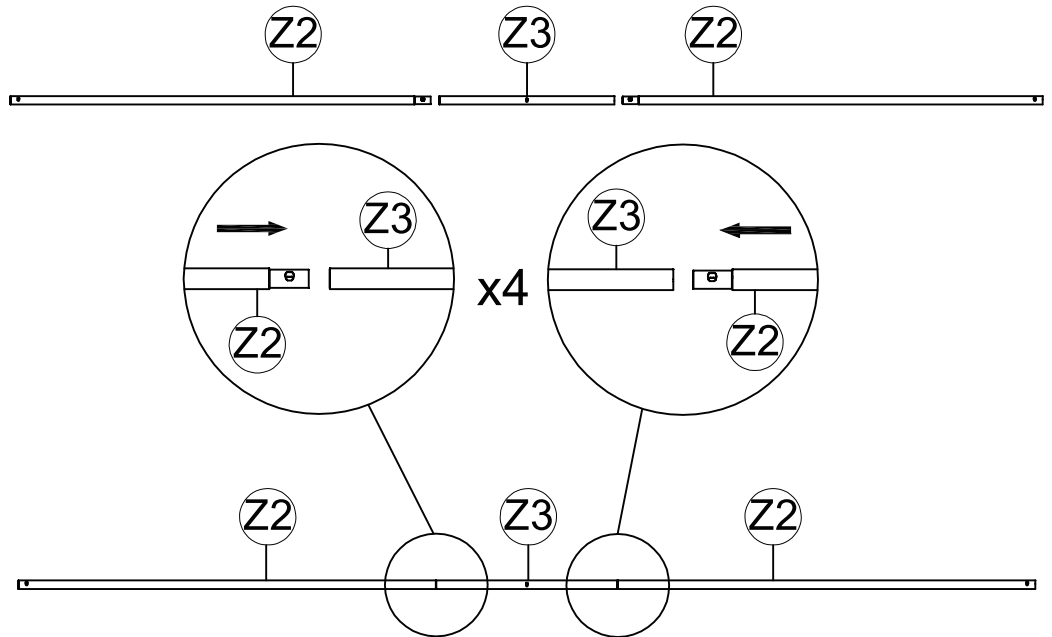
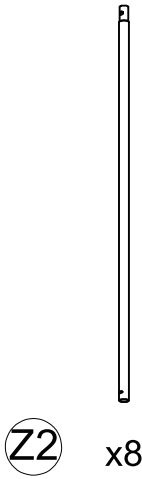
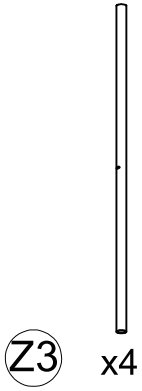

11

As shown in the picture, place the mosquito net support parts (Z4) and (Z5) between the tubes, align the holes, and secure them with screw (KK), washer (H9), and barrel nut (BB).

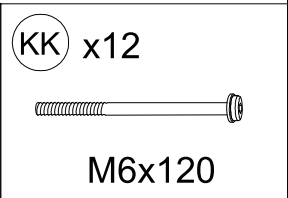
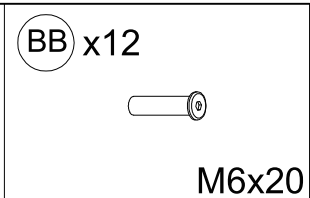
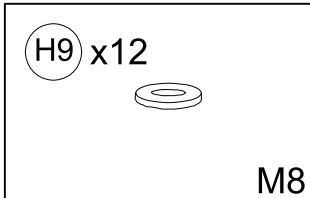
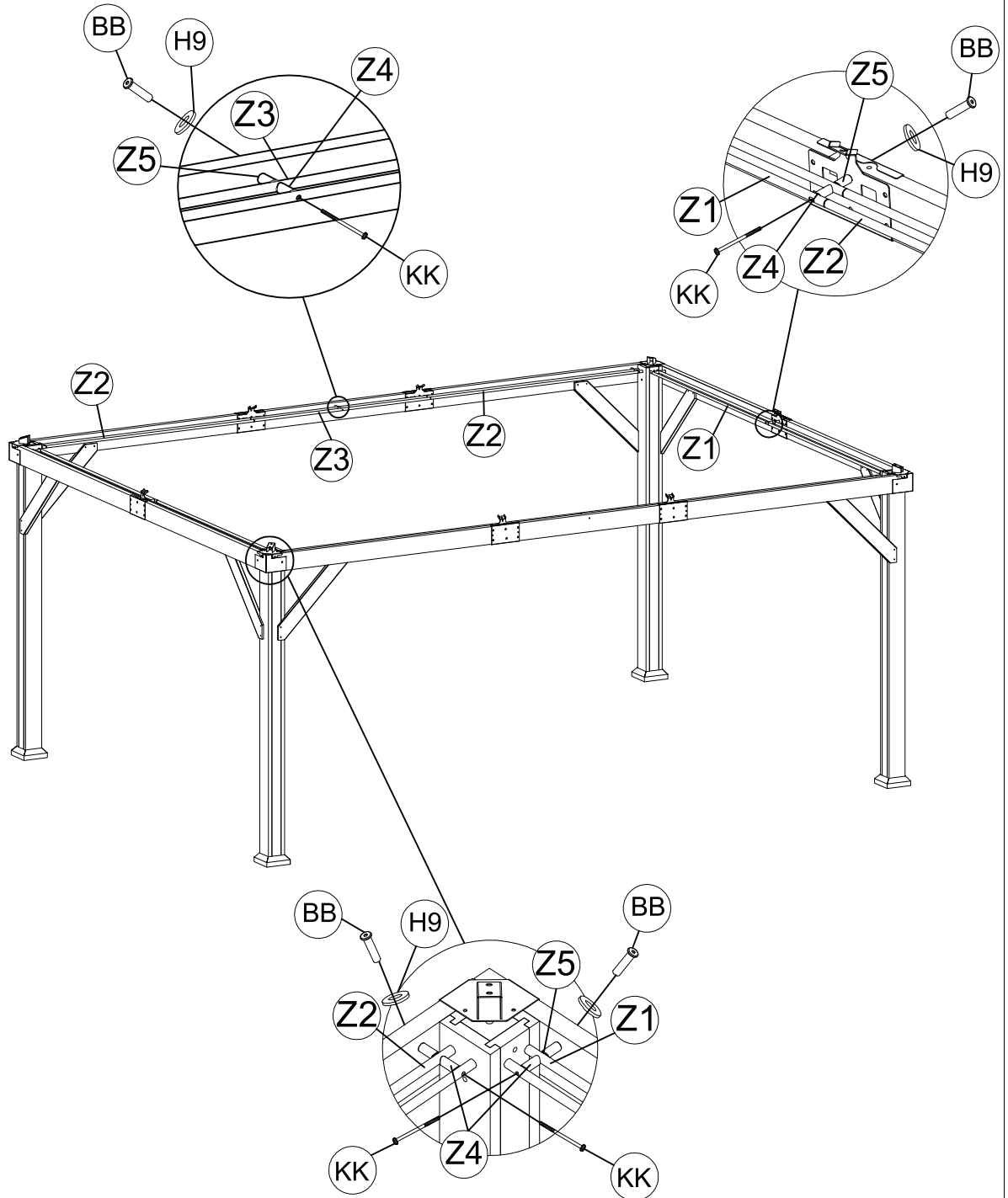
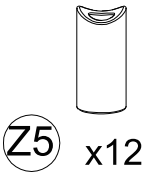
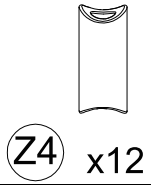

12

As shown in the picture, connect the upper connector of the main top diagonal beam (D) with the short frame tube (D5) and long frame tube (D6), using screw (GG) to secure.

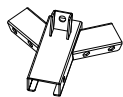

D x4



D5 x2



D6 x2

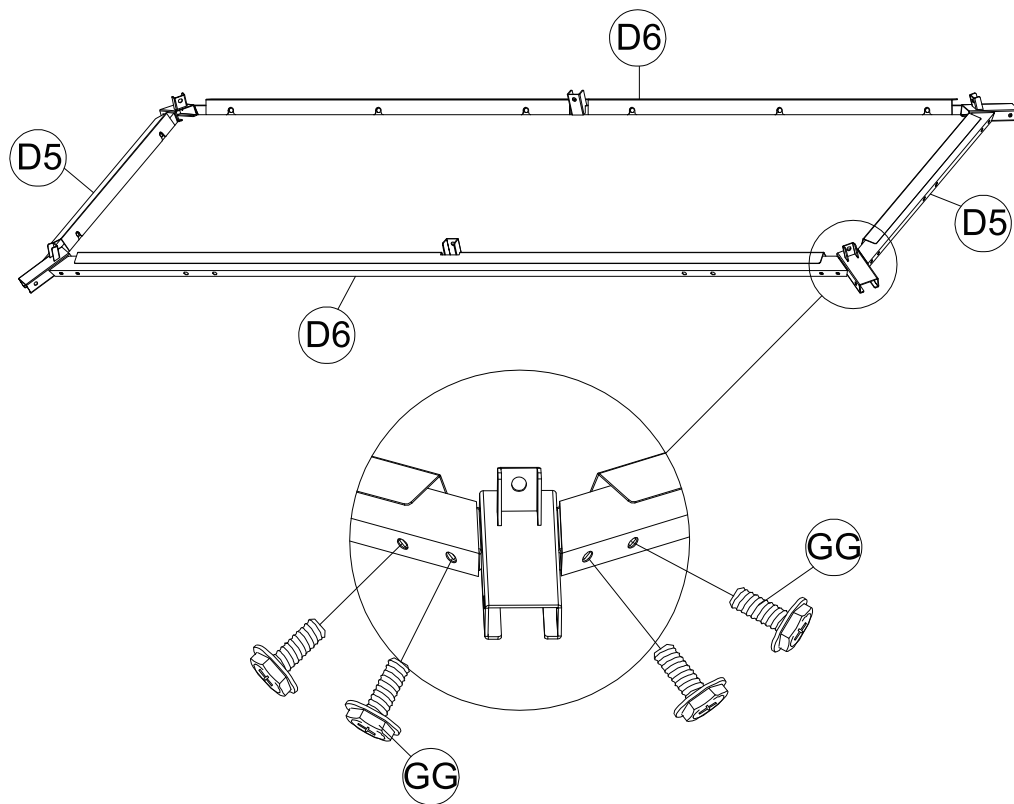
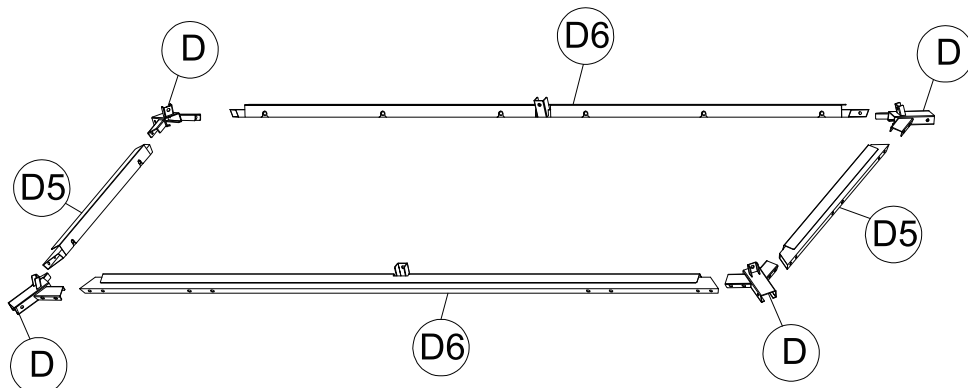

GG x16

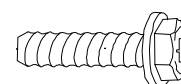

M6x15

13

As shown in the picture, connect the lower main top diagonal beam (G2) with the upper main top diagonal beam (G1) using screw (GG).

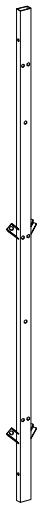

G1 x4



G2 x4

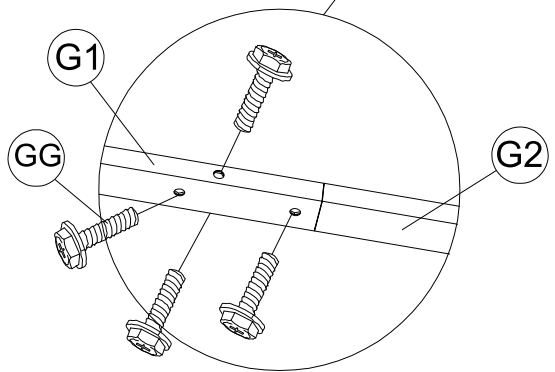
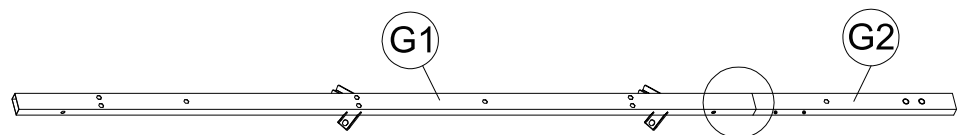

GG x16

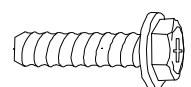

M6x15

14

As shown in the picture, connect the center beam (J1) to the beam connector (T2) using screw (FF).

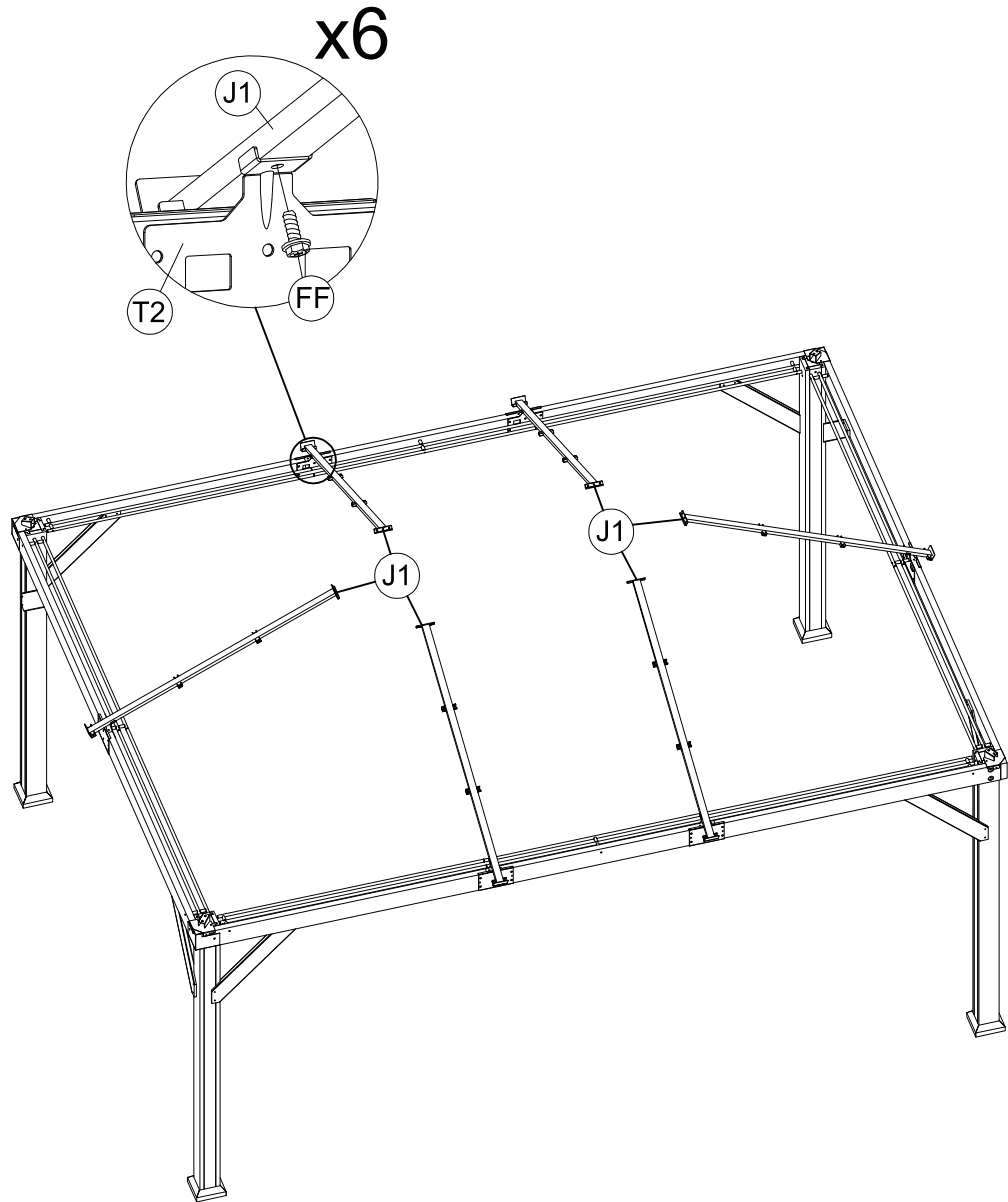
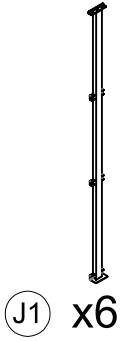

FF x6

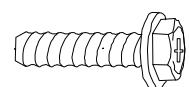

M6x20

15

As shown in the picture, connect the assembly from Step 12 to the center beam (J1) using screw (FF).

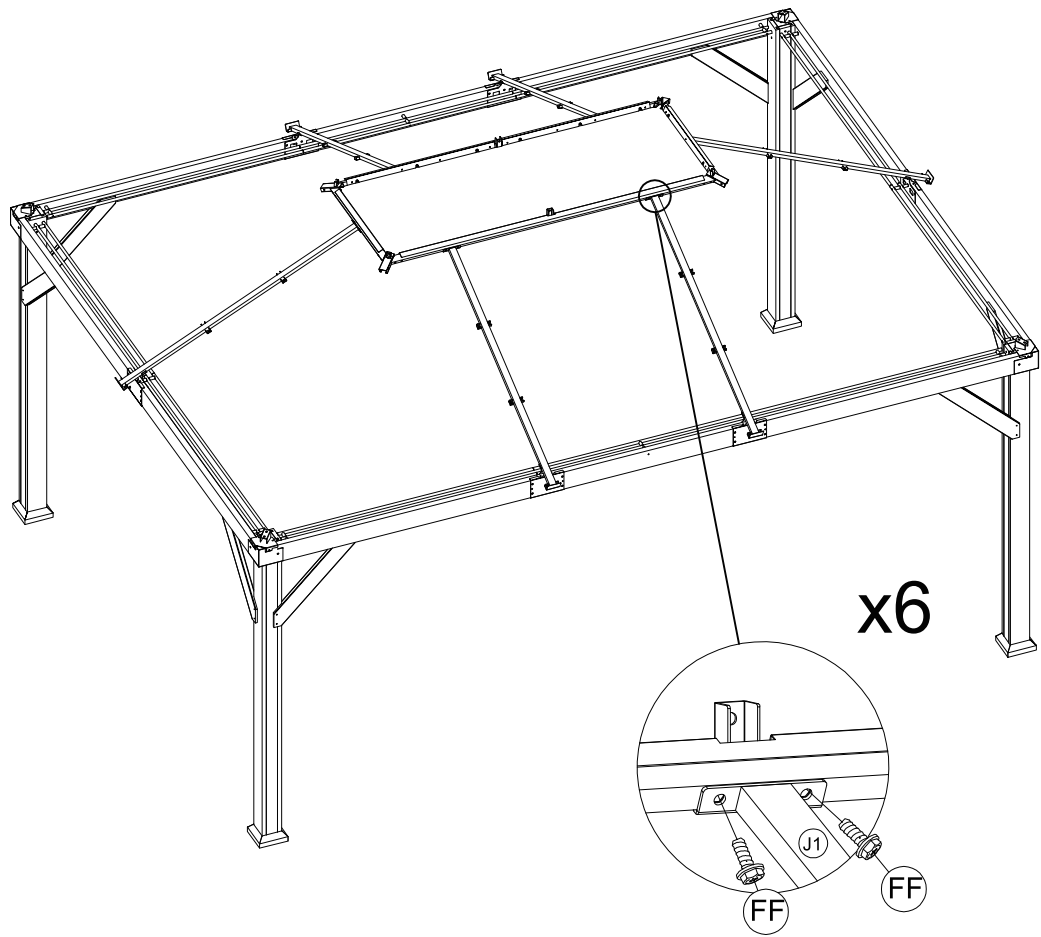

FF x12

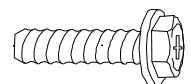

M6x20

16

As shown in the picture, connect the assembly from Step 13 to the upper main top diagonal connector (D) using screw (JJ), washer (H5), and nut (DD). Then connect it to the lower diagonal beam connector (T4) using screw (CC).

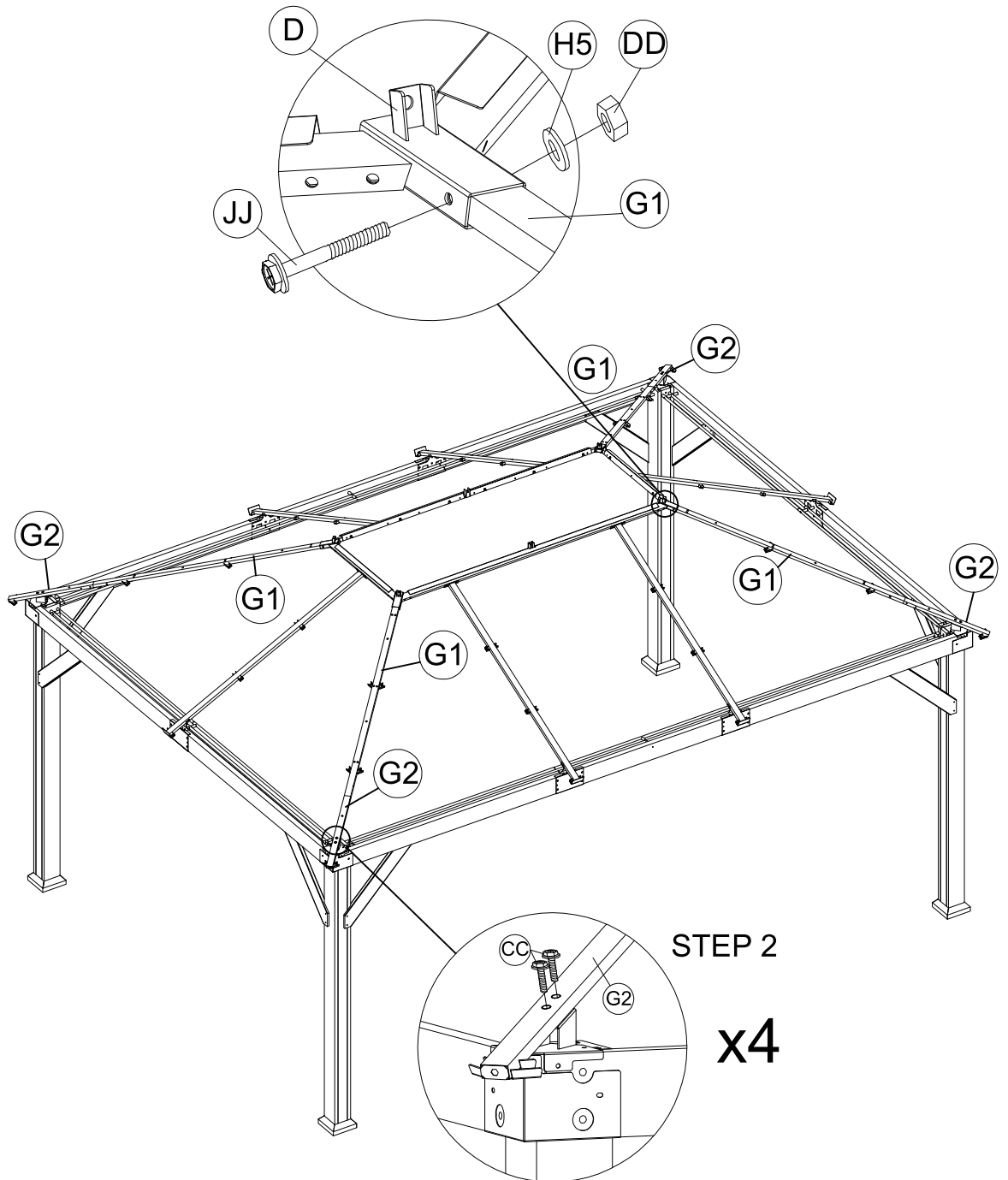

Ⓚ DD x4



M6

Ⓚ H5 x4



M6

Ⓚ CC x8

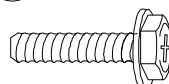

M6x35

Ⓚ JJ x4

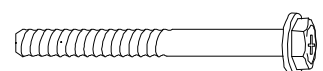

M6x55

17

As shown in the picture, insert the small top diagonal beam (K) into the upper main top diagonal connector (D) and secure with screw (GG). Then connect the small top connector (D4) to the small top diagonal beam (K) using screw (GG).

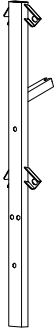

K x4

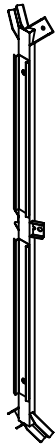

D4 x1

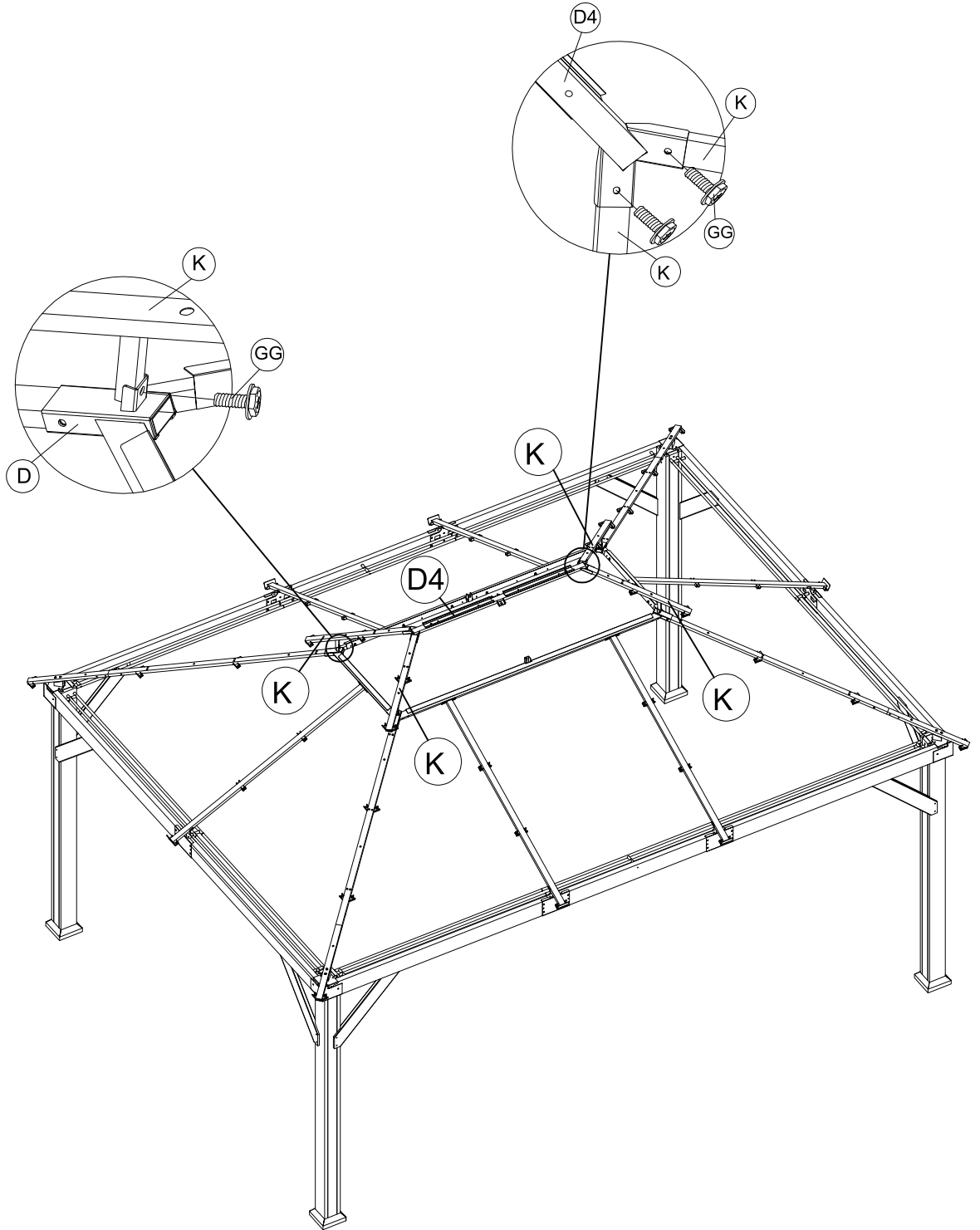

GG x8

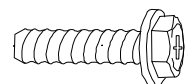

M6x15

18

As shown in the picture, insert the small top center beam (K1) into the long frame tube (D6) and secure with screw (GG).
Then connect it to the small top connector (D4) using screw (GG).

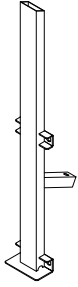

(K1) x2

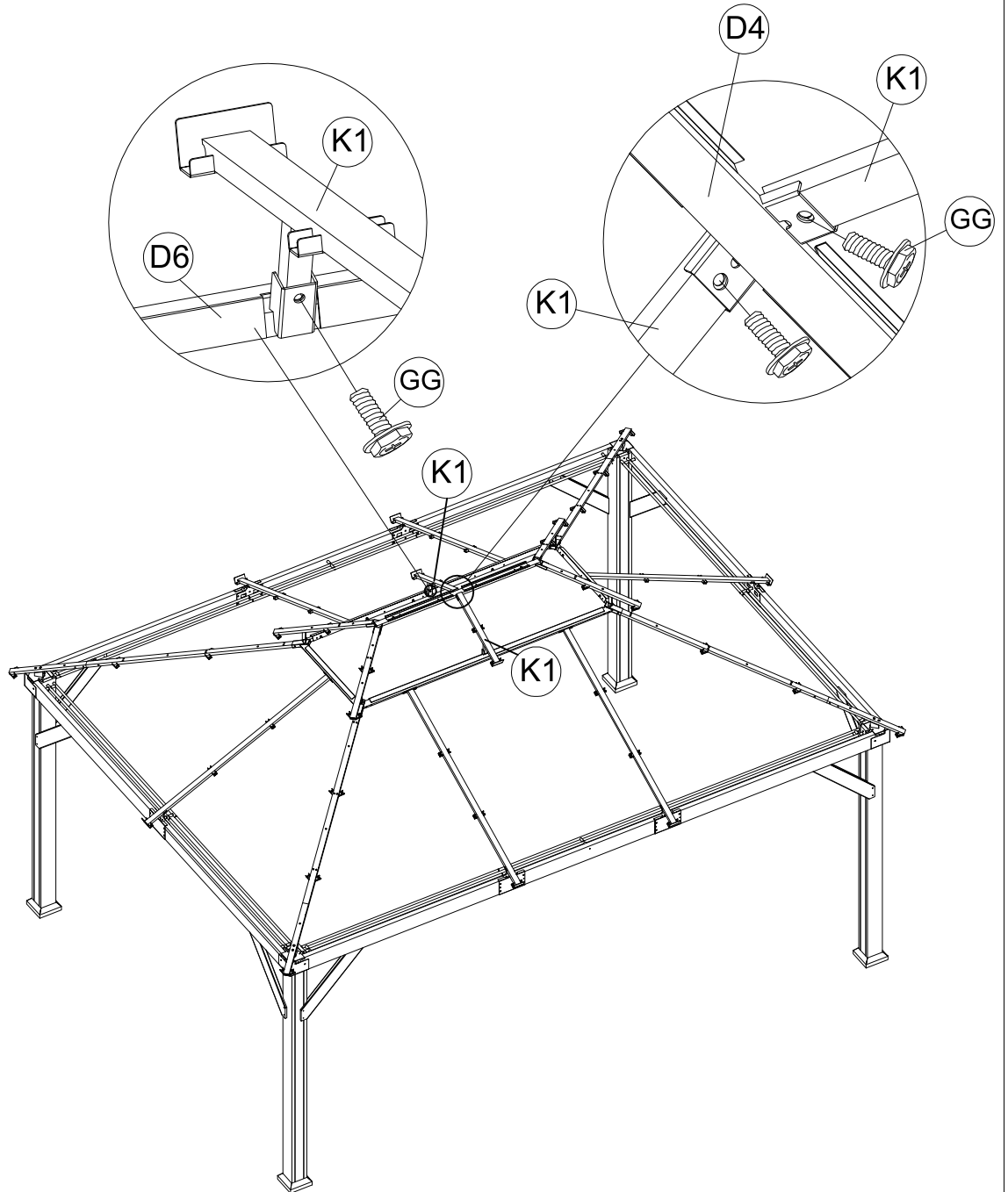

(GG) x4

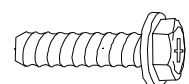

M6x15

19

As shown in the picture, align parts (L1) and (L3) with the holes, and secure them with screw (GG).

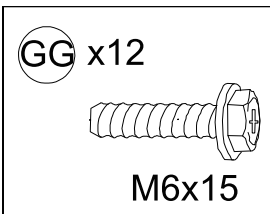
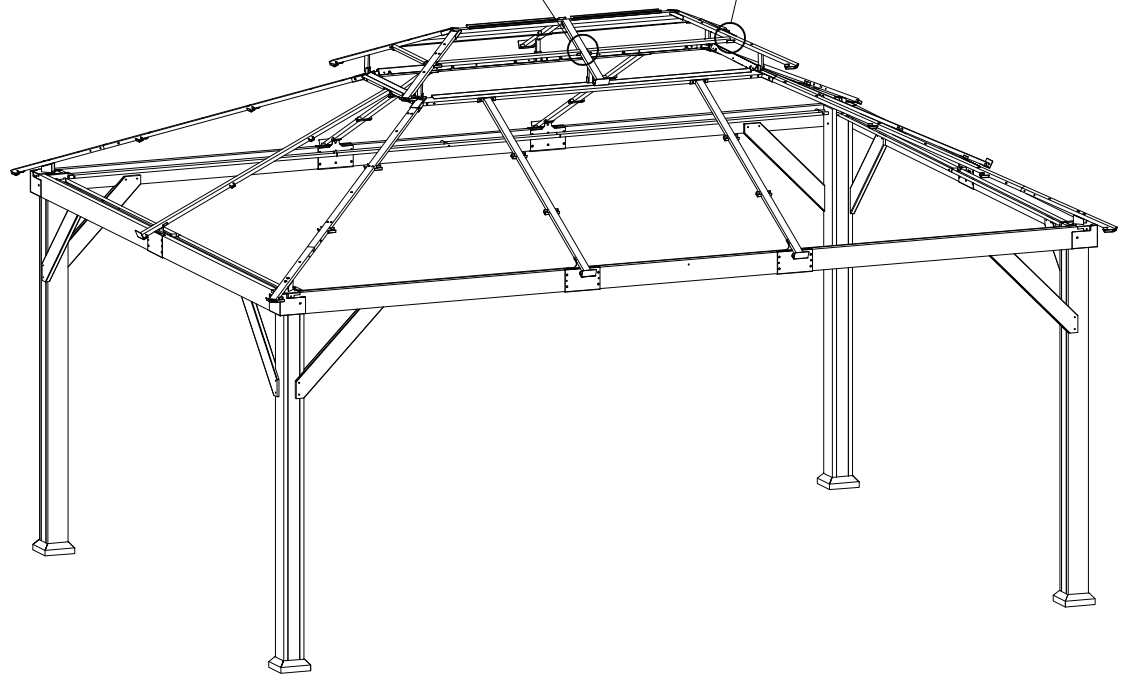
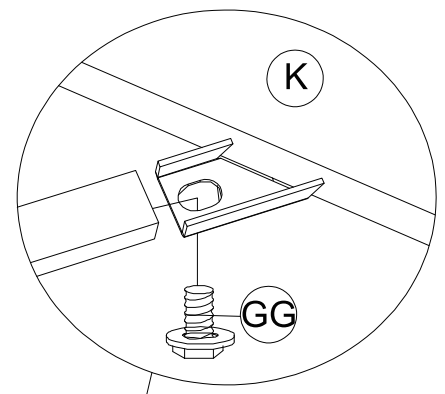
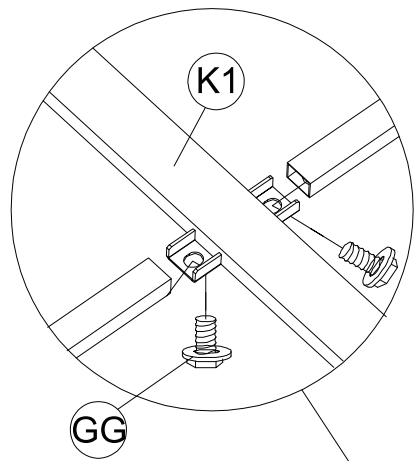
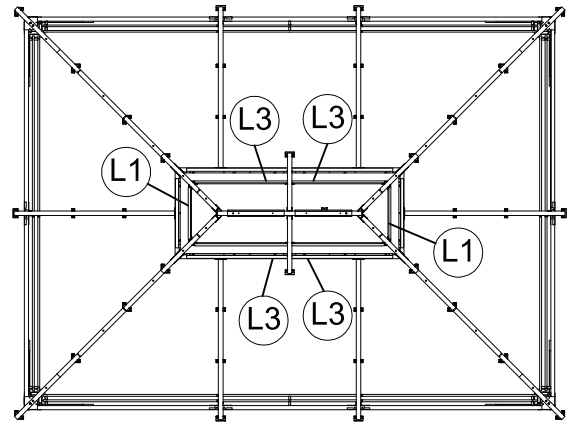
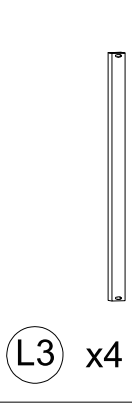
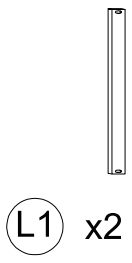

20

As shown in the picture, align parts (M1), (M3), and (M4) with the holes, and secure them with screw (GG).

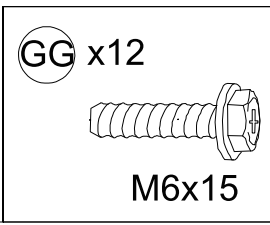
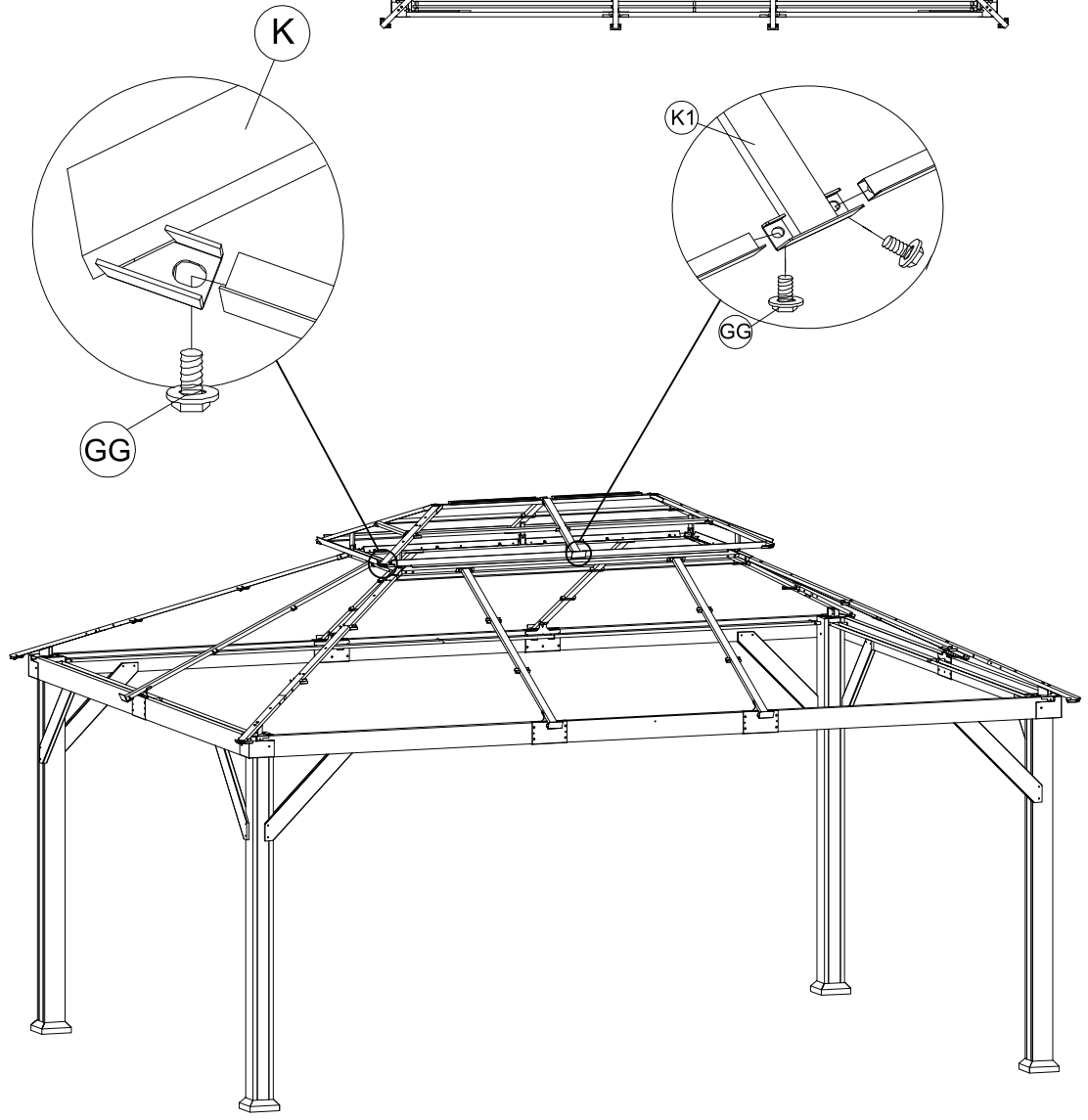
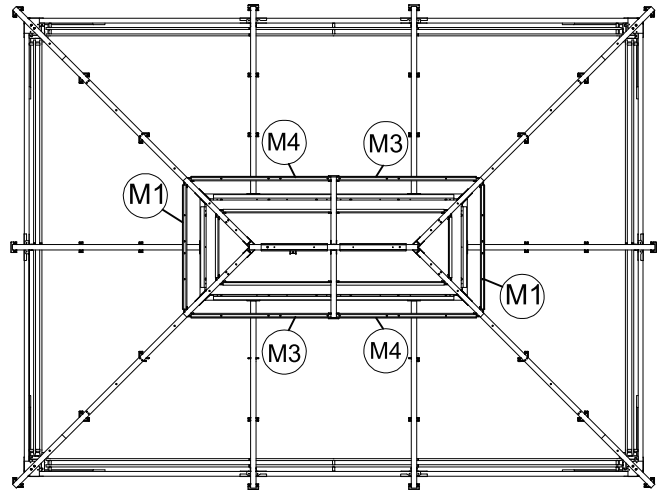
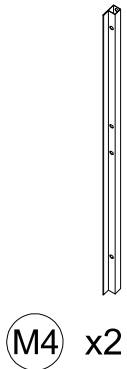
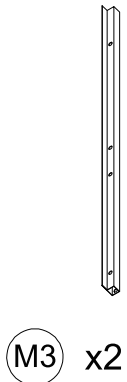
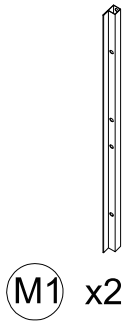

21

As shown in the picture, align parts (P1), (P2), (P4), (P5), and (P6) with the holes, and secure them with screw (GG).

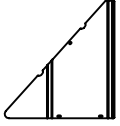

P1 x2

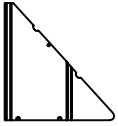

P2 x2

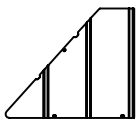

P4 x2

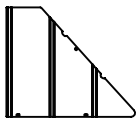

P5 x2

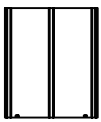

P6 x4

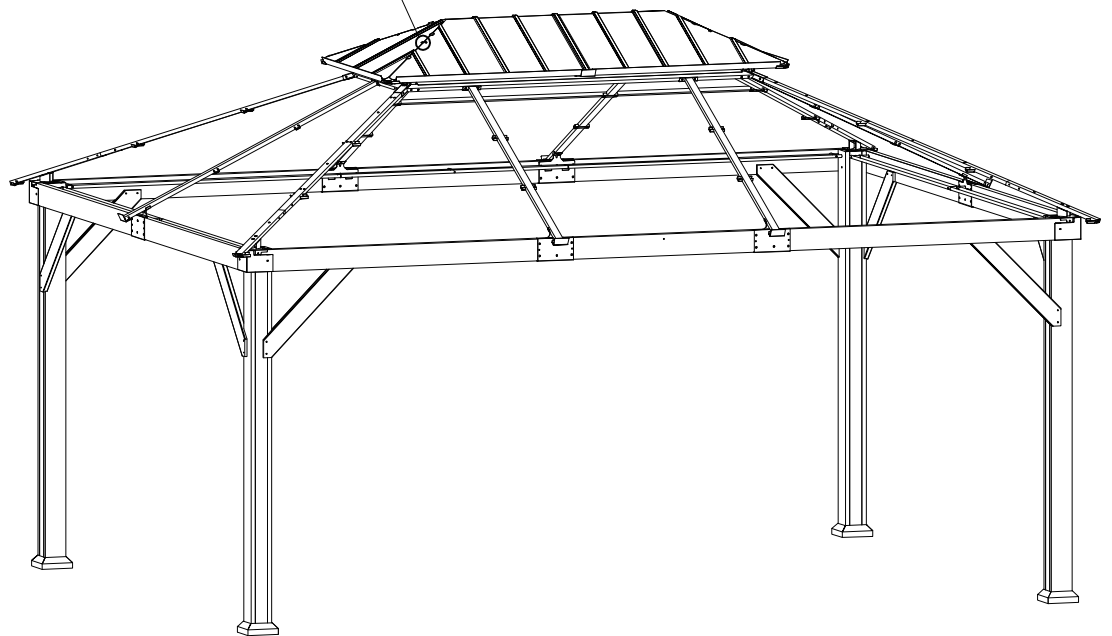
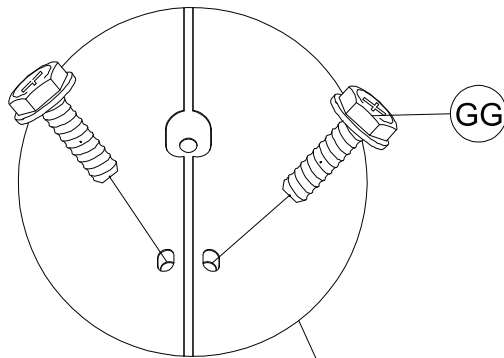
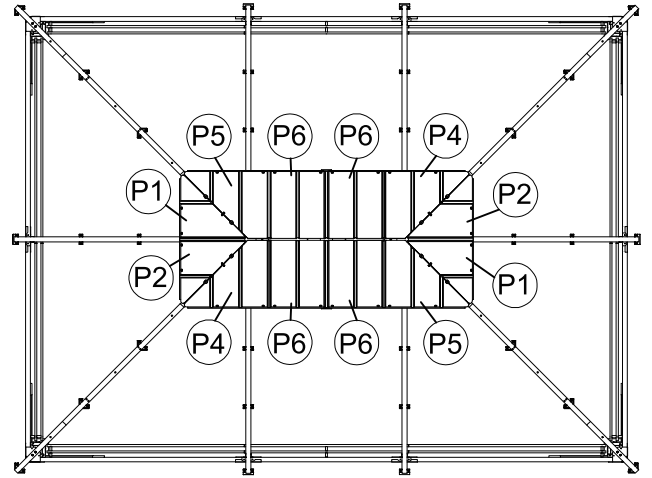

GG x8

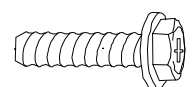

M6x15

22

As shown in the picture, place the press strip (S) over the aligned holes and secure with screw (GG). Then align the diagonal beam blocking plate (Y3) with the holes and secure with screw (CC).

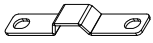

(S) x8



(Y3) x4

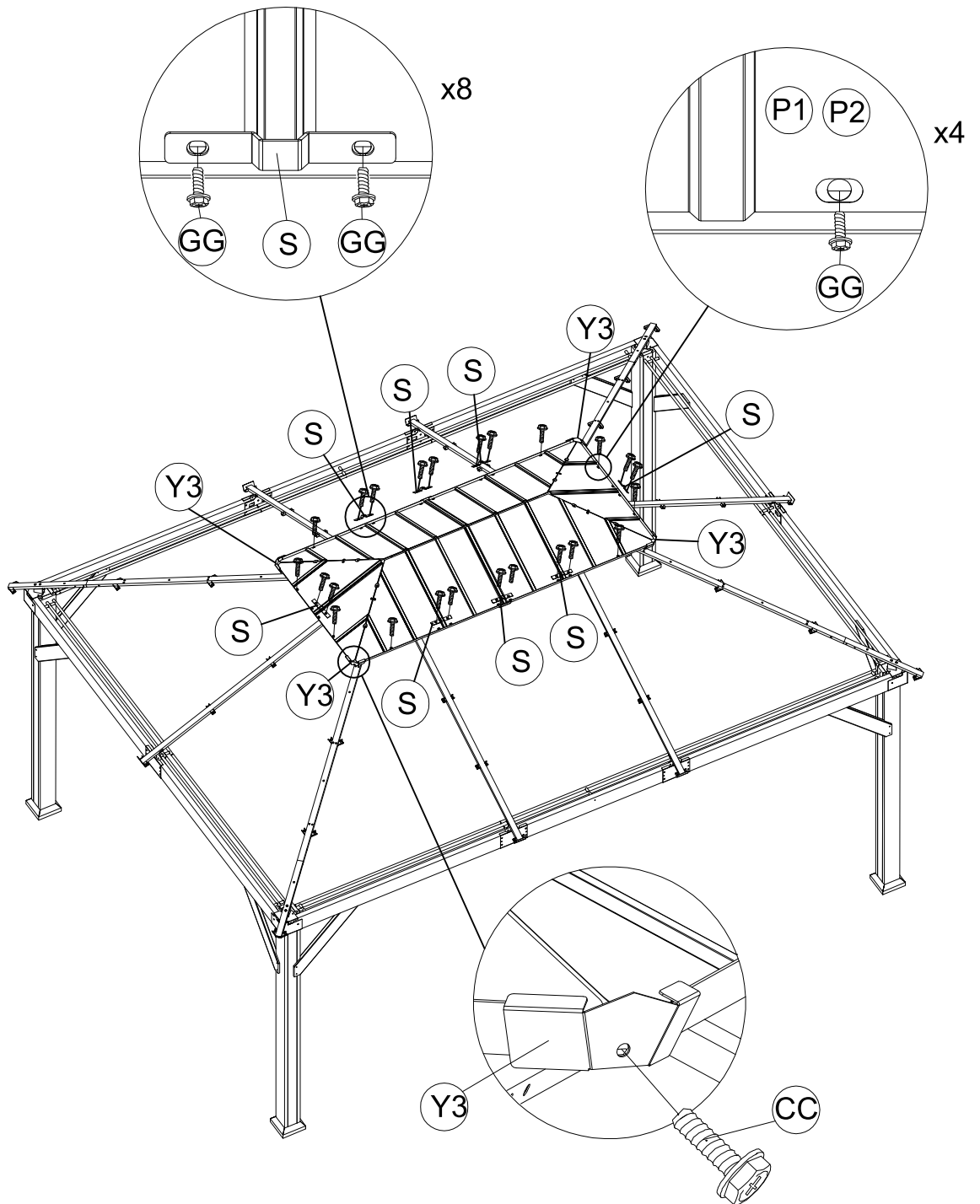

(CC) x4

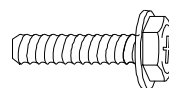

M6x35

(GG) x24

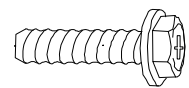

M6x15

23

As shown in the picture, first align the small top diagonal beam cover 1 (R6) and small top diagonal beam cover 2 (R7) with the holes and secure with screw (QQ). Then attach the top cover (R3) to the small top connector (D4) using screw (QQ). Finally, screw the hook into the small top connector (D4).

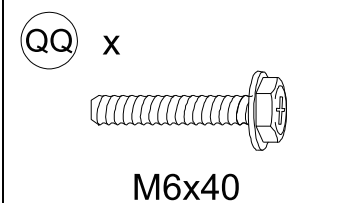
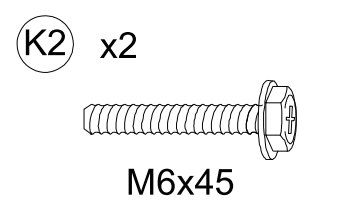
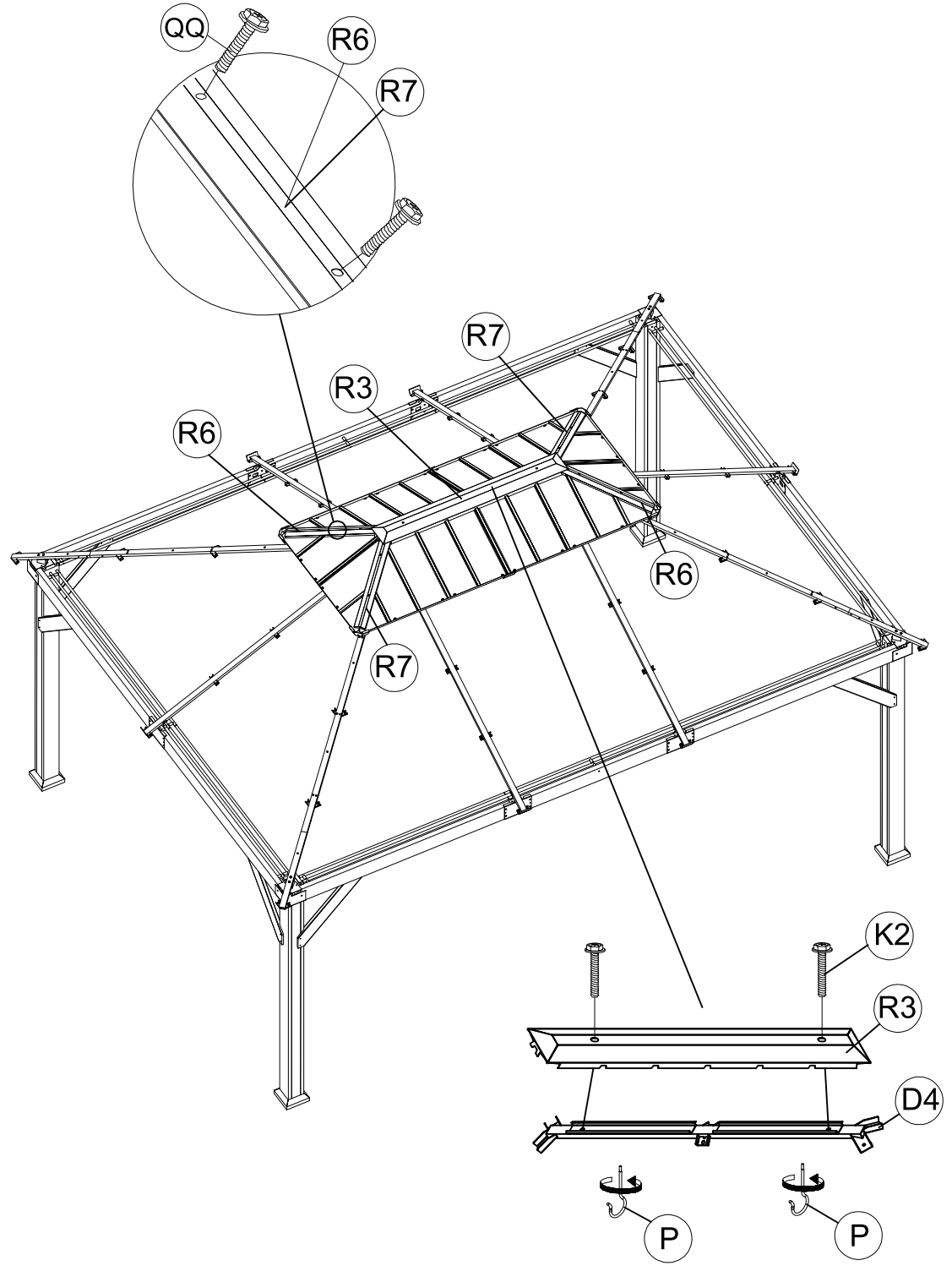
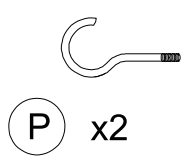
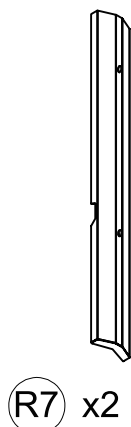
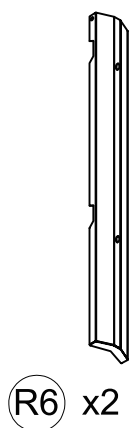
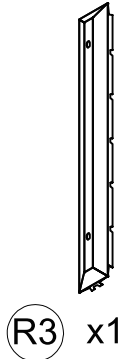

24

As shown in the picture, align parts (L5), (L6), and (L8) with the holes and secure with screw (GG).

(L5) x8



(L6) x8



(L8) x4

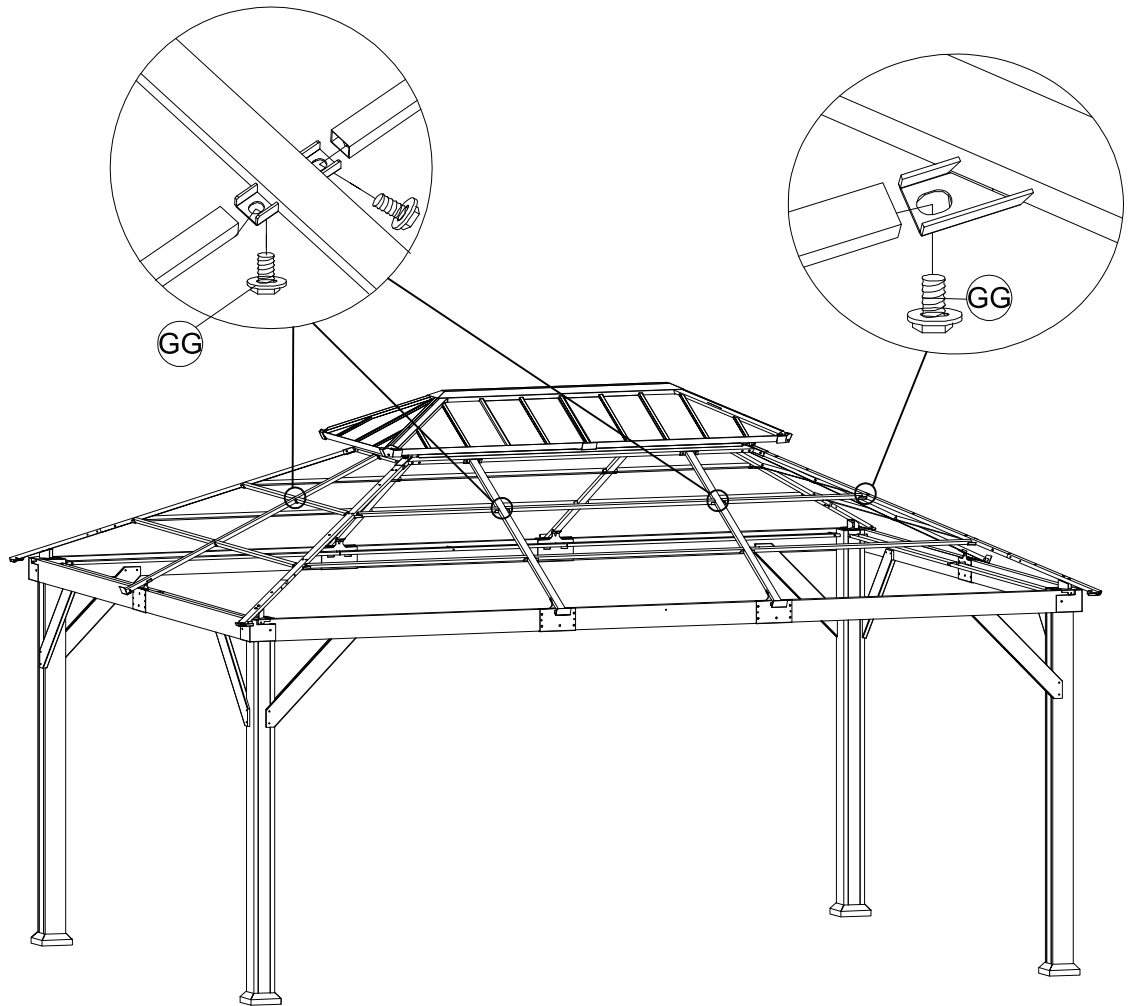
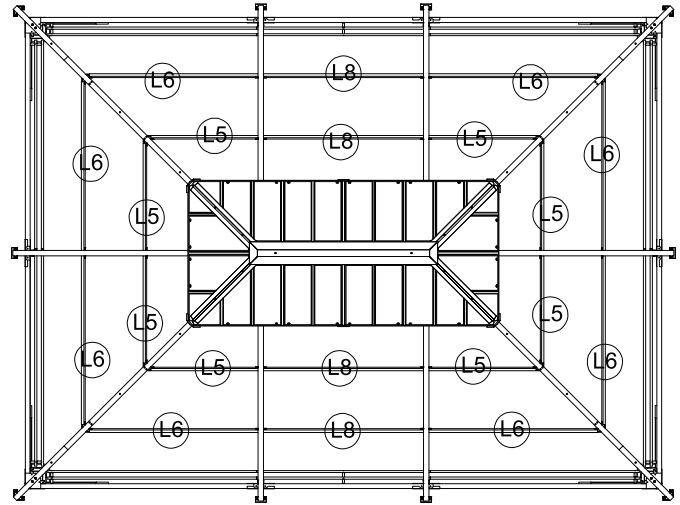

(GG) x40

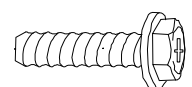

M6x15

25

As shown in the picture, align parts (M7), (M8), and (M10) with the holes and secure with screw (GG).

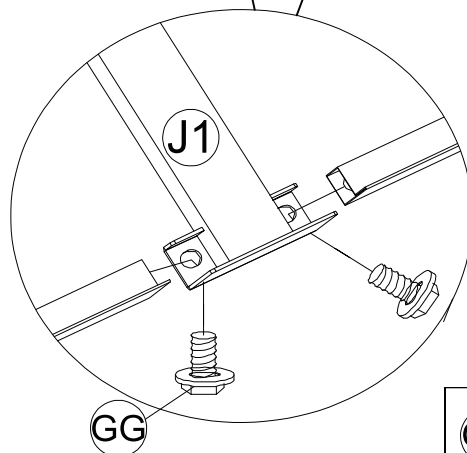
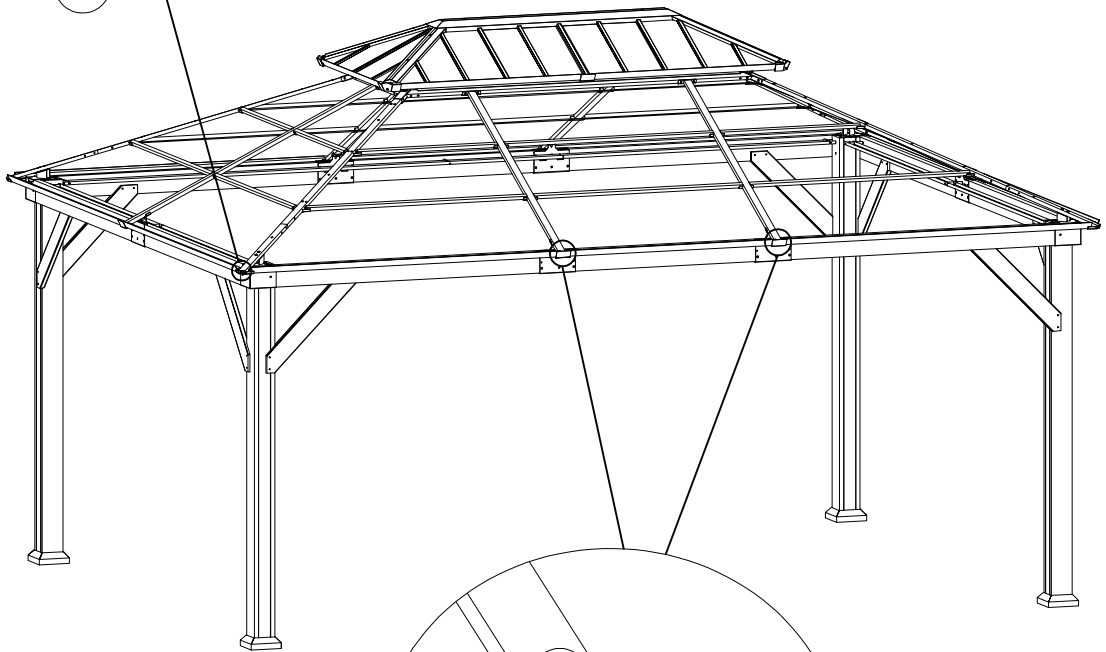
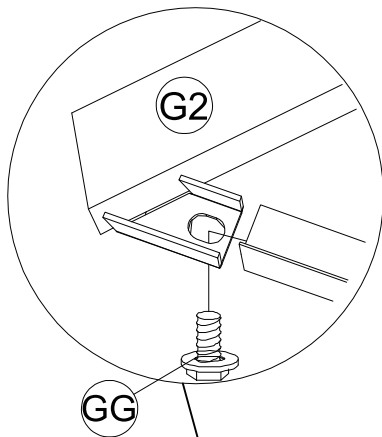
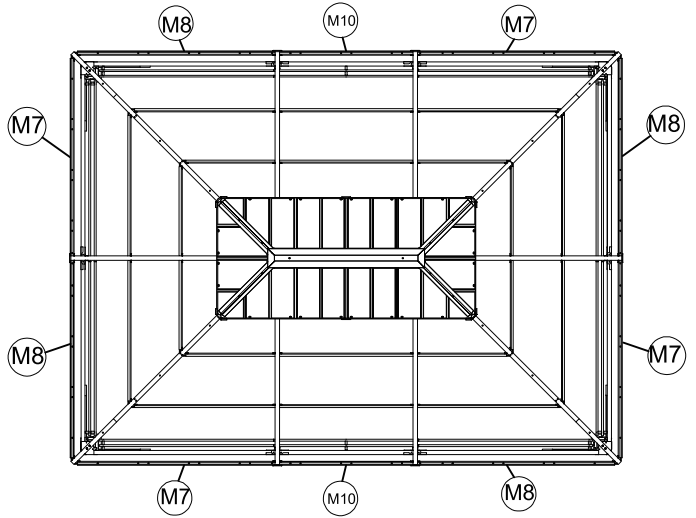
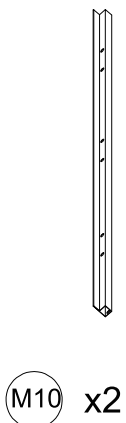
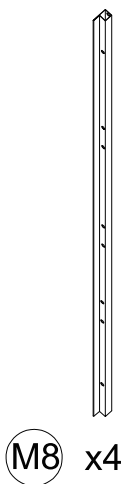
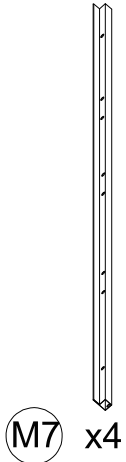

(GG) x20

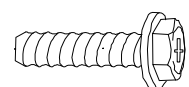

M6x15

26

As shown in the picture, align parts (Q1), (Q2), (Q3), (Q4), (Q5), (Q6), and (Q7) with the holes and secure with screw (GG).

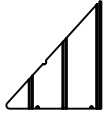

Q1 x2

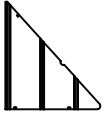

Q2 x2

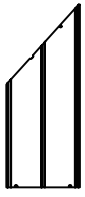

Q3 x2

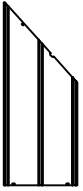

Q4 x2

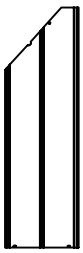

Q5 x2



Q6 x2

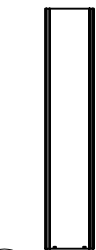

Q7 x4

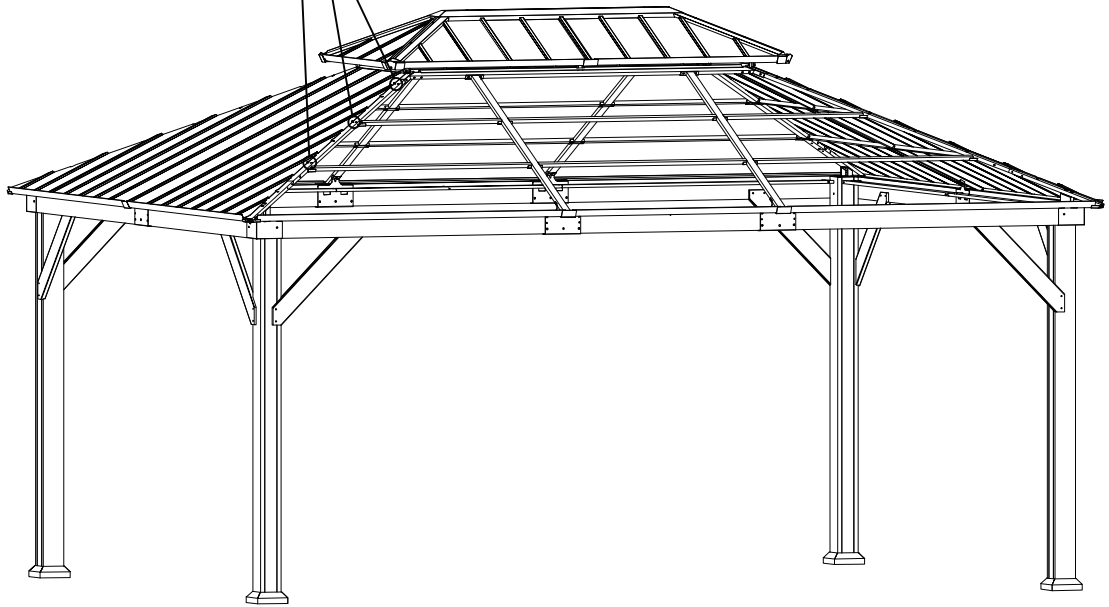
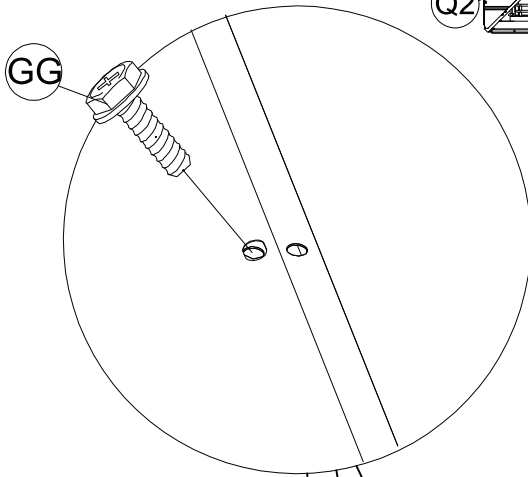
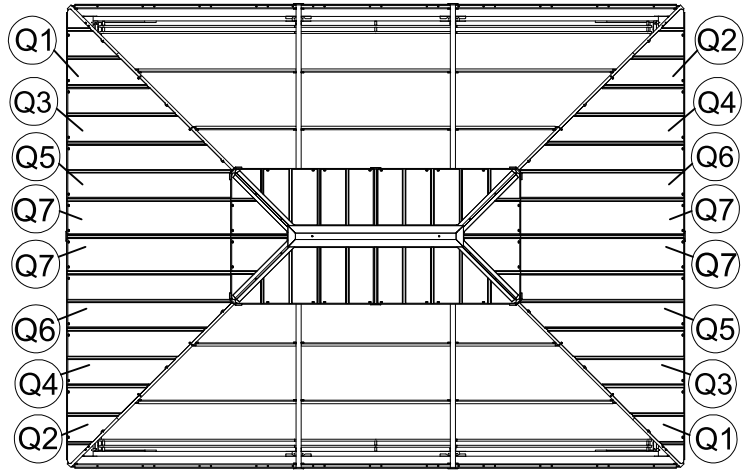

GG x12

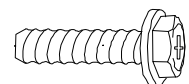

M6x15

27

As shown in the picture, align parts (Q1), (Q2), (Q3), (Q4), (Q5), (Q6), (Q7), and (Q9) with the holes and secure with screw (GG).

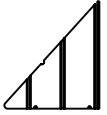

Q1 x2

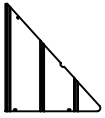

Q2 x2

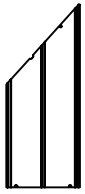

Q3 x2

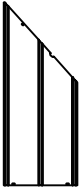

Q4 x2

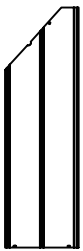

Q5 x2

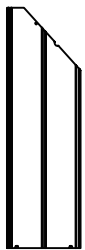

Q6 x2

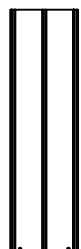
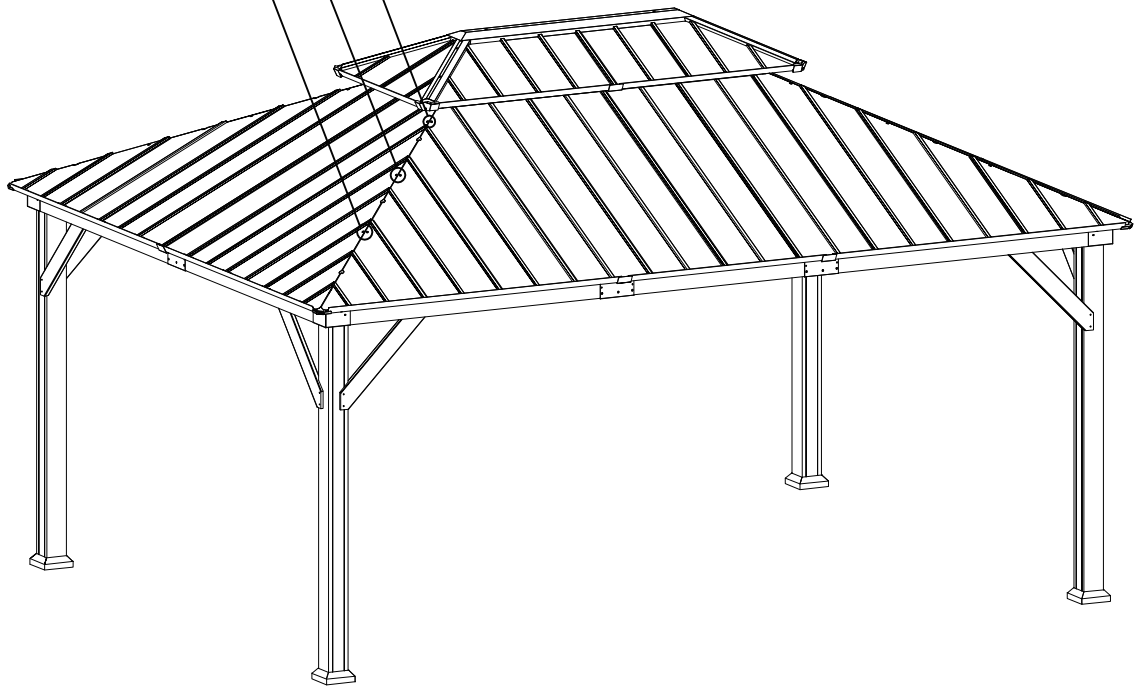
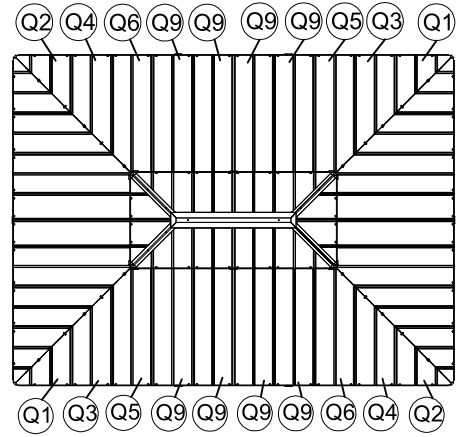
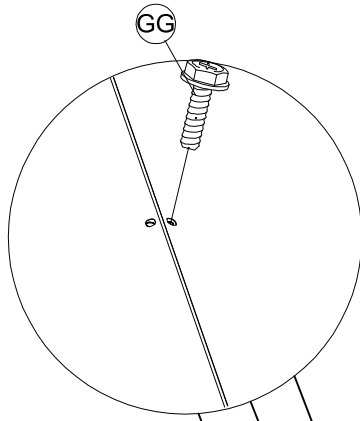

Q9 x8

GG x12

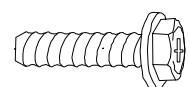

M6x15

28

As shown in the picture, place the press strip (S) over the aligned holes and secure with screw (GG). Then align the diagonal beam blocking plate (Y3) with the holes and secure with screw (CC).

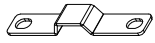

(S) x32



(Y3) x4

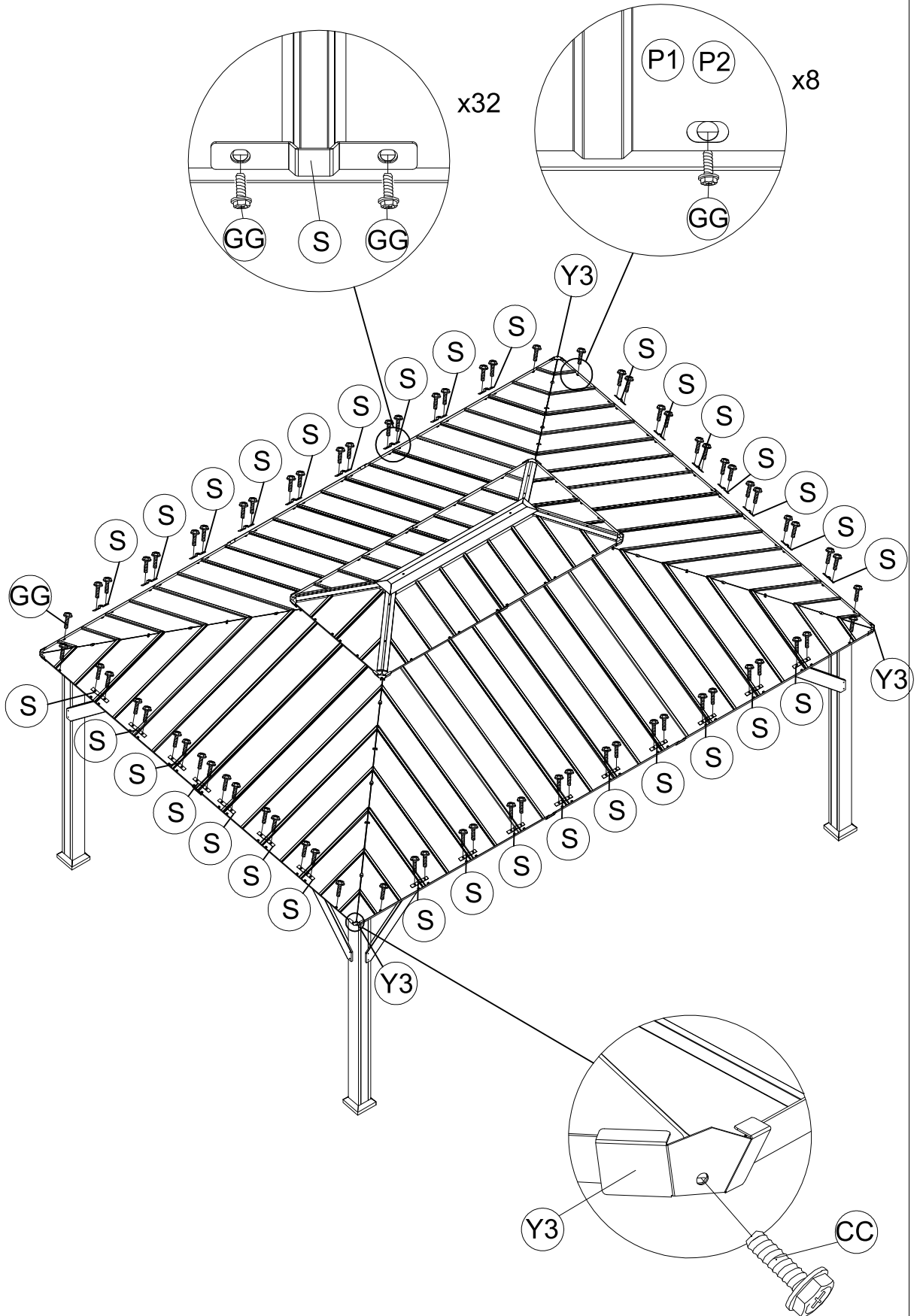

(CC) x4

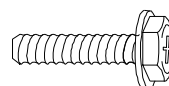

M6x35

(GG) x72

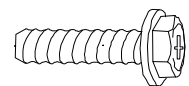

M6x15

29

As shown in the picture, align the upper cover plate of the main top diagonal beam (R4) and the lower cover plate of the main top diagonal beam (R5) with the holes and secure with screw (QQ).

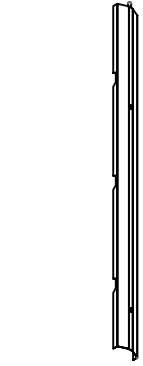

R4 x4

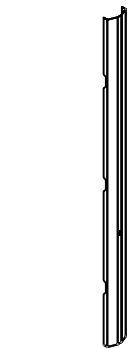

R5 x4

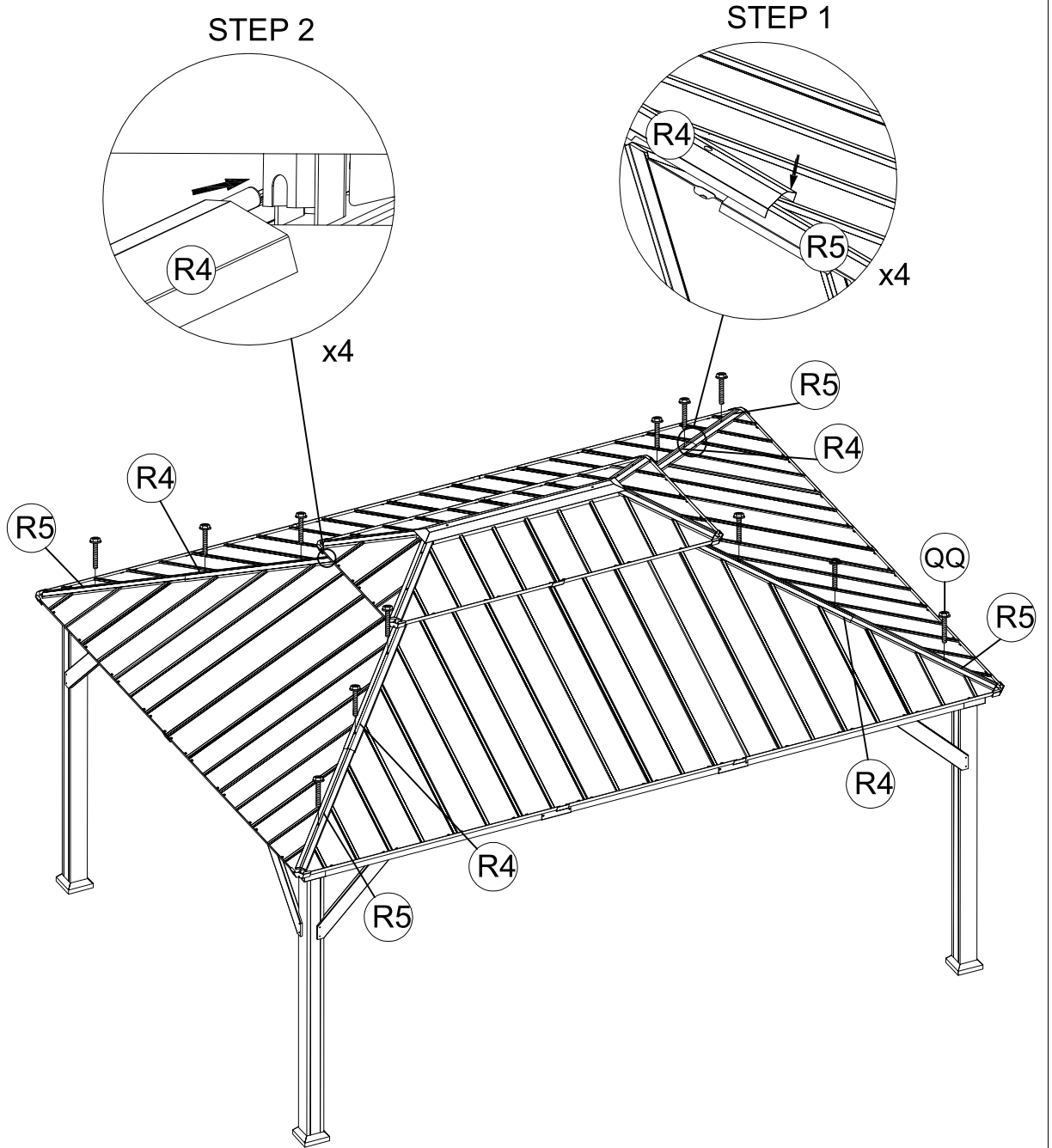

QQ x12

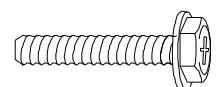

M6x40

30

As shown in the picture, attach the plastic clips (HH) to the mosquito net tubes, then insert the side curtain (V1) into place.

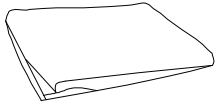

V4 x1

7

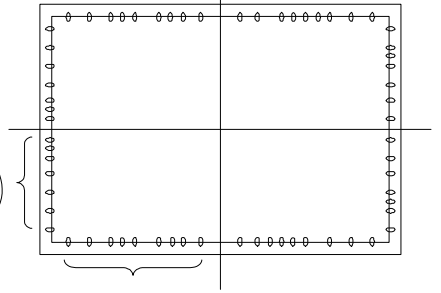

9

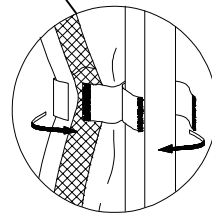
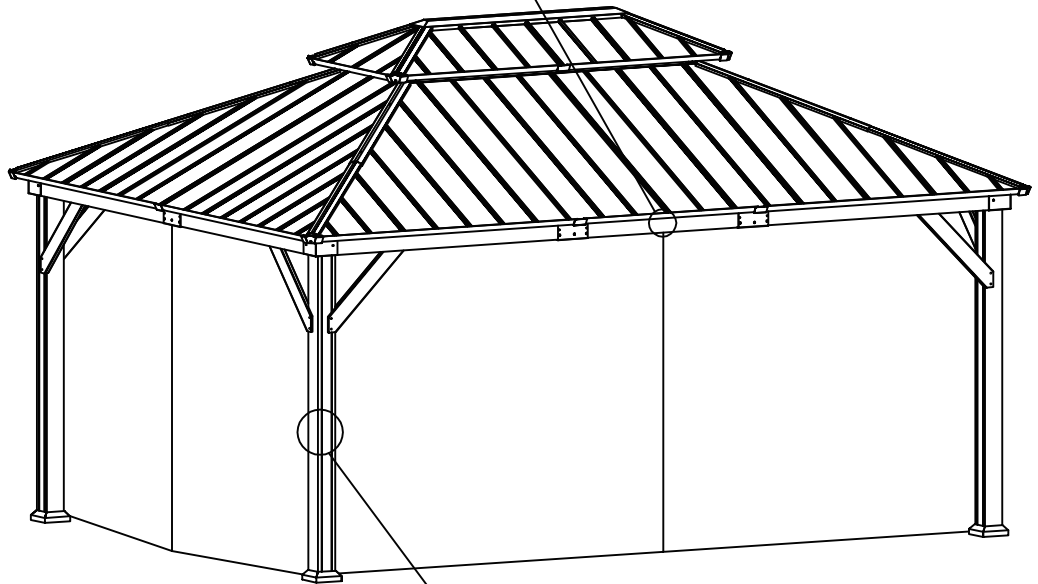
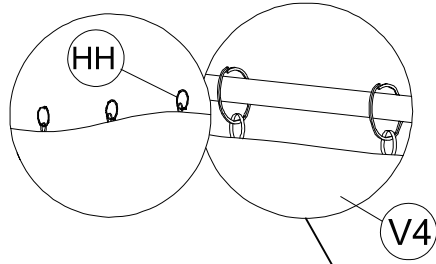

HH x64



31

As shown in the picture, attach the plastic clips (HH) to the mosquito net tubes, then insert the mesh (U1) into place.

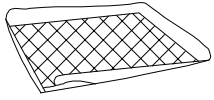

U4 x1

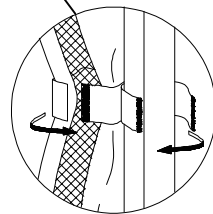
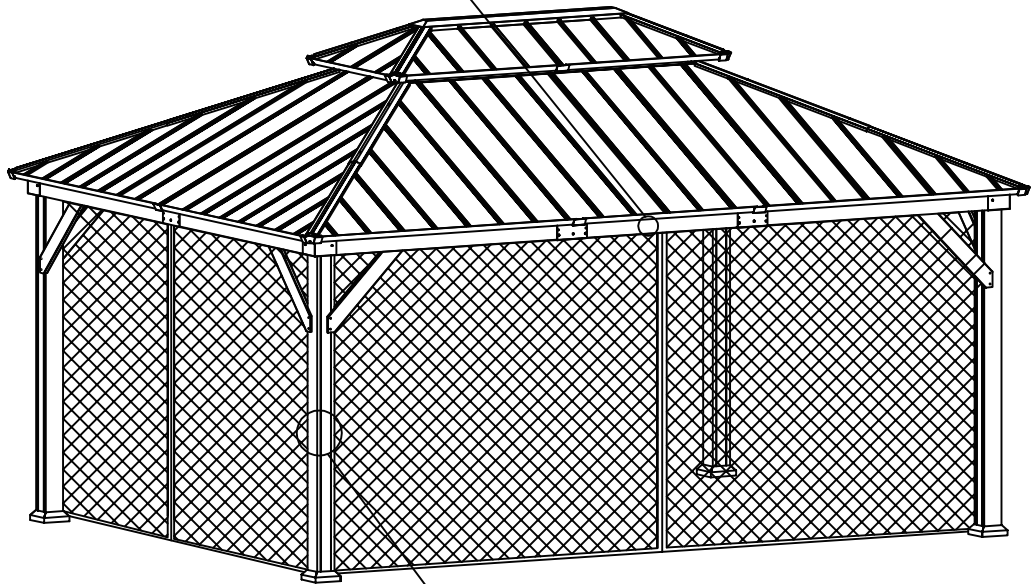
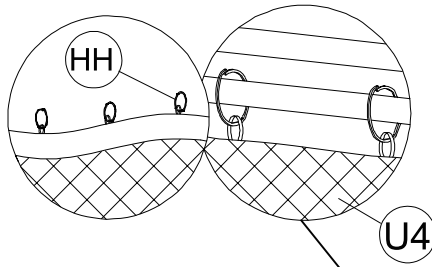
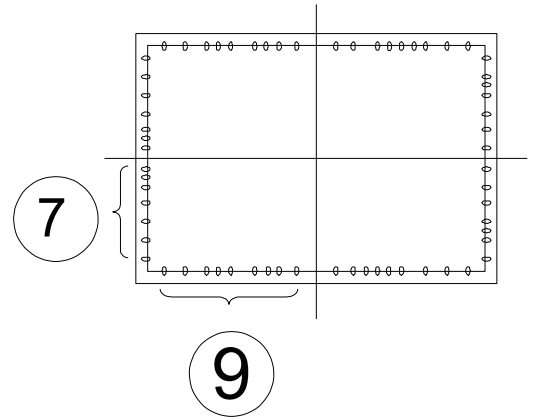

HH x64



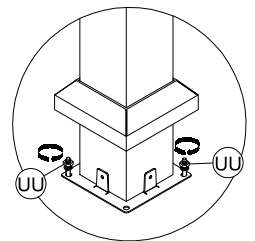
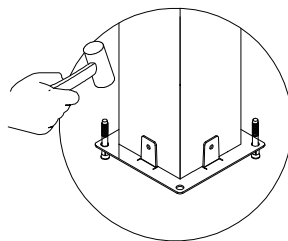
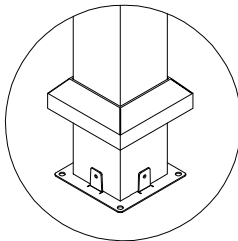
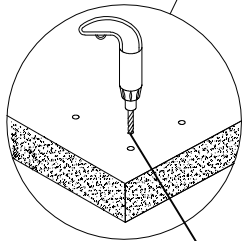
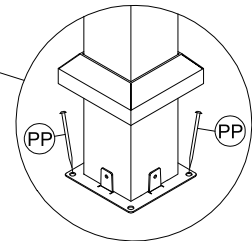
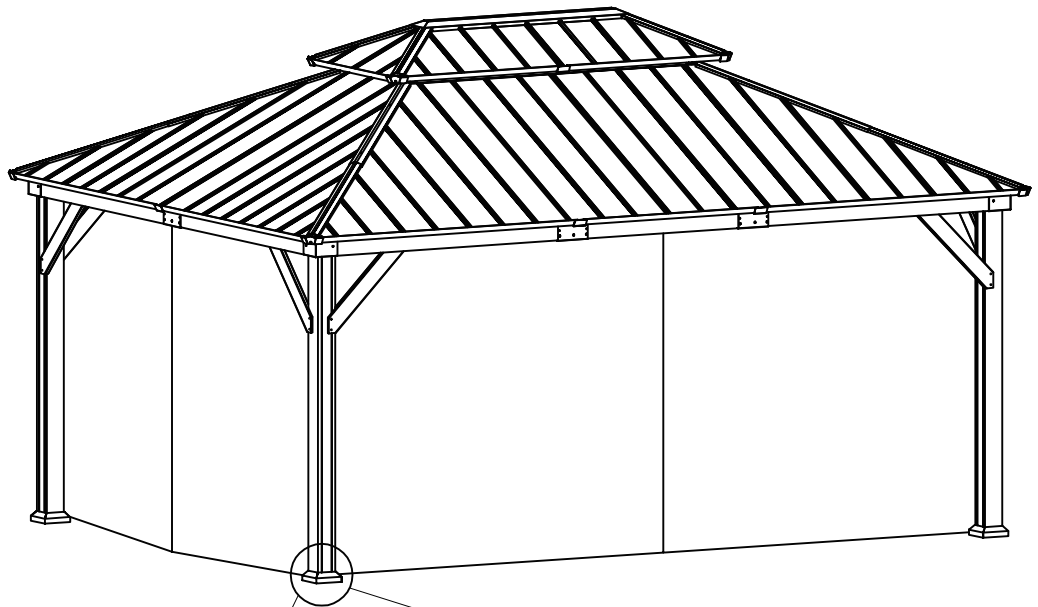

Drill size $\geq \text{Ø}10$

UU x8

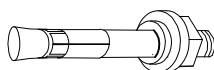

M6X80

PP x8



D8X180

|Gazebo

SKU

BG14L8-1A2A1
BG14L8-1A2A2
BG14L8-1A2A3
BG14L8-1A2A4
BG14L8-1A2A5
BG14L8-1A2A6

V1.0