



INSTALLATION INSTRUCTIONS



- **Model 1201**
- **RV/Mobile Home Series**
- **2 or 3 Hole Installation**

For easy installation of your faucet please:

- **READ ALL** the instructions, warnings, care and maintenance information before beginning
- Purchase the correct water supply hook-up

You may need:

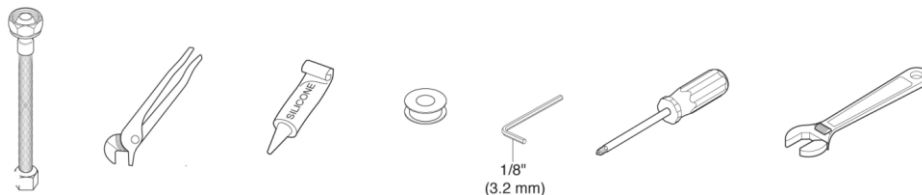

1. Before Proceeding

We recommend calling a professional if you are uncertain about installing this product! This product should be installed in accordance with all local and state plumbing and building code requirements.

2. Shut Off Water Supplies

Locate the water supply inlets and shut off both the hot and cold water supply valves. If you are replacing an existing faucet, remove the old faucet. Clean the sink surface thoroughly in preparation for the new faucet.

3. Assemble the Spout

Assemble the spout as shown using **hand tighten ONLY**.

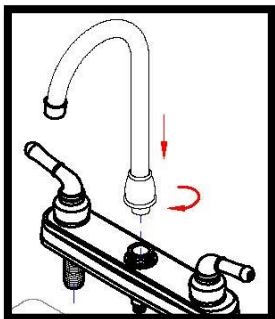

4. Place the Gasket

Make sure to attach the gasket to the faucet before proceeding to step #5.

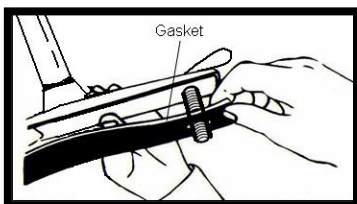

5. Secure New Faucet

Position the faucet on the sink. If the sink surface is uneven, a small amount of silicone sealant may be needed. Secure locknuts on the shank and hand tighten.

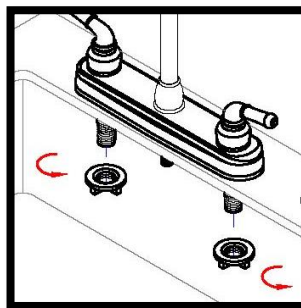

6. Connect to Water Supplies (Hook-Ups Not Provided). Flush System/Check for Leaks

Connect the hot and cold water supplies to the shanks as shown. Remove the aerator. Turn the handle all the way on. Turn on hot and cold water supplies and flush water lines for one minute. This flushes away any debris that could cause damage to internal parts. Check all connections for leaks. Replace aerator. Re-tighten if necessary, but do not over tighten.

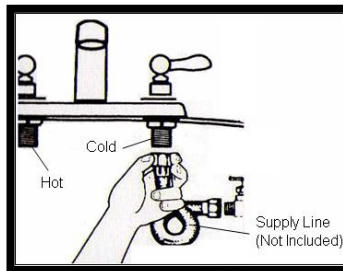

CLEANING AND CARE

Care should be given to the cleaning of this product. Although the finish is extremely durable, it can be damaged by harsh abrasives or polish. To clean, simply wipe gently with a damp cloth and blot dry with a soft towel.

WARNING: SCRUBBING BUBBLES® BATHROOM CLEANER, LYSOL® BASIN TUB AND TILE CLEANER, and all other chemical cleaners must not be used on the faucet body and handle. Use of these cleaners can crack and/or severely damage the faucet. If overspray of these cleaners gets onto the faucet, immediately dry with a soft cotton cloth.

MAINTENANCE

If faucet exhibits very low flow

- Remove and clean aerator

If faucet leaks under the sink

- Inspect all supply line connections, tighten where necessary

If faucet leaks from under handle

- Remove handle. Ensure bonnet nut is tight. Clean or replace the o-ring

- **WARNING: Failure to securely tighten bonnet nut could result in water damage**

FIVE YEAR LIMITED WARRANTY

Foremost Import LLC warrants to the original purchaser that its products will be free from defects in workmanship and materials. We recommend using a professional plumber for all installation and repairs. This warranty DOES NOT COVER LABOR CHARGES AND/OR DAMAGE INCURRED IN INSTALLATION, REPAIR, OR REPLACEMENT AS WELL AS ANY OTHER KIND OF LOSS OR DAMAGES. Any damage to this faucet as a result of misuse, abuse, or neglect, WILL VOID THE WARRANTY. This warranty applies only for faucets installed in the United States of America.

Replacement parts may be obtained by writing to customerservice@foremostimport.com

Proof of purchase from the original purchaser must be made available to Foremost Import LLC for all warranty claims. This exclusive written warranty is not transferable.