

# Assembly Intruccion

INTRUCCION DE MONTAGE  
MONTAGEANLEITUNG  
SAMLEVEJLEDNING

1

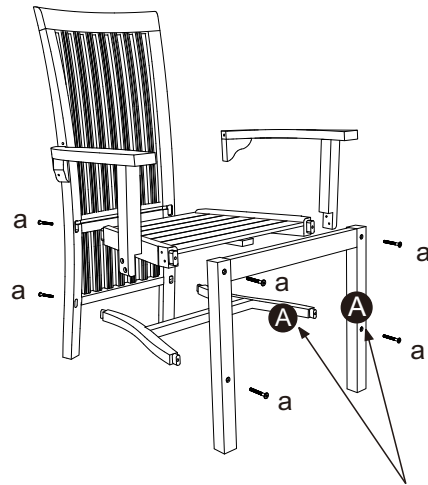

**MAKE SURE THE LETTERS  
MATCH BEFORE ASSEMBLING**

2

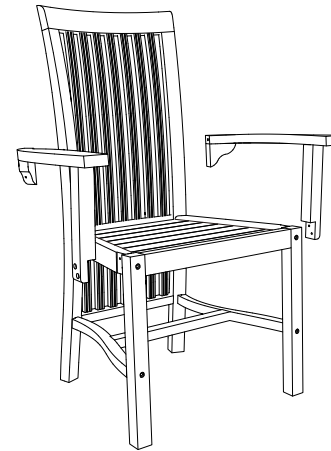

3

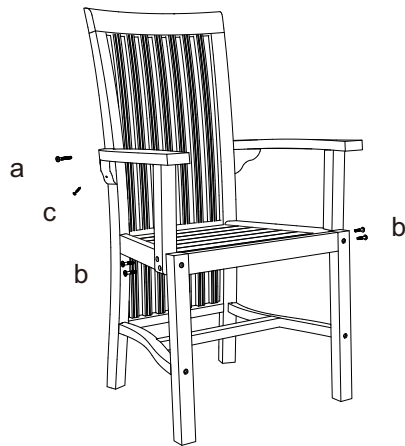

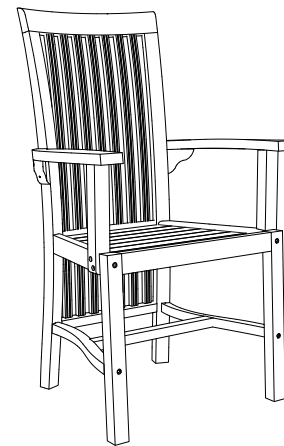

Make sure to use Glue (Included) on all  
wood joints before assembly

4



## Hardware

a   
BOLT 2' ( 10 pcs )

b   
BOLT 1,2' ( 4 pcs )

c   
SCREW 1,2' ( 2 pcs )

## Tool



Socket Wrench 4mm

## Total Section

6 Section